

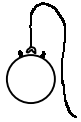

# Breaking The Code To Language And Communication:

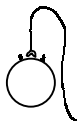

## The Ultimate Puzzle For A Child With Autism!

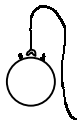
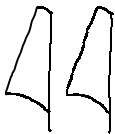
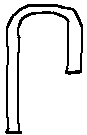
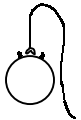

By: Jeanne A. Brohart

<http://www.autismhelpforyou.com>

Autism Help For You  
Copyright 2003

## **Dedication**

**To my husband, Frederick...**

**for his unfailing love and support**

**And...**

**To “our pearls”, Anika and Zachary...**

**for allowing us to see life, so differently...**

**through your eyes...**

<b>Table of Contents</b>	<b>Page</b>
Dedication	2
Table of Contents	3
Special Note to Readers	4
Put Those Yellow Pieces Back In Their Place!	5
Looking Back...	12
Brain Structure and Function Overview	14
Common Ground	18
<b><i>Duplicate Language Section From Book 2</i></b>	<b>41</b>
<i>Teaching Language In Building Blocks</i>	<b>41</b>
<i>Fascination With Captions</i>	<b>43</b>
<i>“Ordering Or Reference Language” (once called “nonsense language)</i>	<b>45</b>
<i>ABCs To “Breaking The Code” Of Language</i>	<b>55</b>
<i>Phonics</i>	<b>60</b>
<i>Words</i>	<b>70</b>
<i>Talking In Labels And Commands</i>	<b>72</b>
<i>Conversation</i>	<b>73</b>
<i>Sentence Compartmentalization/Bubble Graphs</i>	<b>75</b>
<i>Synonyms, Antonyms, Homonyms, Homophones, Acronyms</i>	<b>89</b>
<i>Words To Cope... Words Of Encouragement...Words To Help Understand...</i>	<b>92</b>
<i>Words To Teach Quantity</i>	<b>93</b>
Updates To Language Section Overview From Book 2	94
Building Critical Bridges...	137
The Key To Order And Understanding In The Midst Of Chaos!	137
Left Brain... Right Brain... What’s The Difference?	150
<b><i>Duplicate Section From Book 3 – Some New Materials Also – As Indicated</i></b>	<b>160</b>
<i>The Mystery In The Right Temporal Lobe...</i>	<b>160</b>
Emotions... Clues To Overcoming The “Stuck On High” Control Knob...	185
<b><i>Duplicate Section From Book 3 – But, Absolutely Critical Section!</i></b>	<b>204</b>
<i>Pronoun Confusion... And The Loss Of Self...</i>	<b>204</b>
Difficulties In Discipline...	209
Failing Schools? Failing Teachers? Or... Failing Materials?	219
One Piece At A Time... One Day At A Time...	244
Trying To Get Those Kids Talking...	252
<b><i>Appendix of Exercises (approximately 190 pages long)</i></b>	<b>283</b>

## Special Note To All Readers Of This Text

For families of children with autism, there was no doubt that reading the first three books I had written would help tremendously in understanding those issues discussed in this, my fourth book. Given “our journey” was still also very much unfolding, it was difficult to share this journey without providing some repetition in certain areas. I debated as to “how” to write this book and finally came to the conclusion that I had to include materials I had previously covered in my other books. I wanted this book to provide a place to put most of my thoughts on language and/or communication in autism and as such, major sections from other books needed to be included here.

With 50% of children with autism considered “non-verbal”, matters of “repetition of issues previously covered” needed to take a back seat to understanding of the issues. For these children and their families, I needed to make this text as complete as possible – and for those of you who had read my previous works, that meant some repetition. I would indicate “repeating sections” best I could, but I simply had no way around this issue – not if I wanted to make this the text I needed it to be. **Duplicate sections were indicated as such in the Table of Contents and in the text itself.**

It was simply too difficult to discuss language issues and keep telling readers to “go read this section on language in another book”. These sections were simply too critical to the discussion, and as such, they needed to be included here so that those parents picking up this text only – not having read the first three – could also understand the issues clearly. As such, there would be more repetition in this book than I had originally planned to include, but I simply did not see how I could get around it and I hoped all readers understood that.

My previous books were as follows:

1. Saving Zachary: The Death And Rebirth Of A Family Coping With Autism!
2. Breaking The Code To Remove The Shackles Of Autism: When The Parts Are Not Understood And The Whole Is Lost!
3. Breaking The Code: Putting Pieces In Place!

Each of these books was available for downloading – for free – to any immediate family member of a person with autism, schizophrenia or Alzheimer’s – three disorders that, as shown in book 3, were in my opinion, very, very closely related. In my third book, I had provided over 160 parallels between autism and Alzheimer’s and over 140 between autism and schizophrenia. I had also shown the common history of these disorders as well.

*Note: When referring to my previous books, I will often just use “book 1, book 2 or book 3” since it is simply easier to do so.* I encouraged all families to read these three books also.

**Finally, “color” was very much involved in my actual teaching materials – and as such, in my opinion, this text was most useful if printed “in color” – especially – the appendix of exercises!**

**I had included shapes for those who did not have color printers and as such, the concept was still there without colors, but, in my opinion, there could be no denying the impact of colors in Zachary’s life!**

## Put Those Yellow Wheels Back In Their Place!

“Put those yellow wheels back in their place!” - eight words – eight words that were as music to my ears - and yet, the same eight words had resulted in disbelief for my mother-in-law and almost desperation for my nephew, Matthew.

We were visiting my in-laws in Canada when Zachary, my five and a half year old son with autism said those eight words. During this visit, Zachary had discovered K’NEX. K’NEX were toys that allowed you to put together anywhere from a few pieces to several thousand plastic pieces of all shapes, colors and sizes to make your own toys to play with. You could make trucks, cars, trains, rollercoasters, planes, rockets, robots and so much more with these puzzle-like pieces. These toys were available at major retail outlets and were made by K’NEX Industries, Inc. (<http://www.knex.com>).

Earlier that week, I had visited the homes of two of my sisters-in-law – both households were littered with K’NEX and Zachary, on this trip, had been given almost “free access” to them. In no time at all, Zachary had busily started on his own “creations”. As I observed him playing with these toys, I came to an undeniable realization – these toys offered exactly what I had been looking for – a way to make things in many different ways, going in many different directions, with little restriction in terms of “what you can do or create with them”. The flexibility of these toys was indeed amazing and they were made strong enough to last through Zachary’s periods of frustration!

I knew Zachary would indeed experience some frustration as he first started to use K’NEX and would be unable to complete certain things in “just the right way”, but, I also knew, that with a little time, he would easily get the hang of it. And, there was always Anika – the most wonderful sister Zachary could ever have – a sister who was always willing to help alleviate his frustrations by helping him out and making him understand how things work. I knew I was not that good at putting things together and quite frankly, sitting there for possibly hours, trying to figure out how to make some of these toys was not something I looked forward to at first. The model examples provided in the “manual” were great – it was just my desire to do this that was a little on the low side. But, I had gone through so much for Zachary, to help him leave the shackles of autism, that I knew I could get passed the motivation issue, too – if this was something that could help him progress further. And so, that was how K’NEX came to be part of our household, too!

Of course, as luck would have it, the toy I soon came to see as a perfect toy for children with autism had hundreds and hundreds of little pieces of various shapes, sizes and colors – all of which I could now picture in my own home scattered all over – with me having to pick up those hundreds of small pieces untold times and having to be careful not to vacuum them up each time I cleaned the house. I knew I could look forward to finding them in the couch as I sat down, on the floor as I stepped on a part that would poke at my foot, under the furniture, in kitchen and bedroom drawers and in pretty well all parts of the house over time. It seemed I had spent the better part of the last few years picking up hundreds of toy pieces of all kinds – puzzles pieces,

plastic shape pieces, wooden blocks, Lego pieces, Tinker toys pieces, Scrabble letter pieces – and now, the collection of “pieces” would include K’NEX!

Yet, K’NEX were different from the other toys in that they allowed for a great deal more flexibility. In addition, the various shapes that snapped together, I knew would help Zachary with fine motor skills and issues involving limb apraxia.

It had only been recently that I had noticed how Zachary almost went “limp” when you placed a pencil in his hands. I was not sure if it was because he still did not really know how to hold it or if it was more of an issue with nerve damage in the extremities that resulted in weakness in the fingers. It was only recently that I had finally figured out the trick to having Zachary hold a pencil properly – a subject I will address later in this book. I had also recently purchased a couple of small sponge-like balls to work on building strength in Zachary’s fingers as we both squeezed a sponge ball up to thirty times a day. The K’NEX pieces I knew would also help with fine motor skills and issues of strength in Zachary’s fingers as they required just the right amount of strength to snap the pieces together or apart.

In my opinion, these toys were truly perfect for Zachary – providing that “next stage” for development. I knew he would try to make himself “some creation” he could spin because that “urge to spin” was still there when he was idle – as much as I had tried to break it – but I would simply have to deal with the spinning issues. I could easily enough divert Zachary’s attention when it came to “spinning”, but, I still found it hard in the sense that it was still very much something he liked to revert to if not engaged in some other activity and as such, there was still that daily “spinning battle”. Keeping Zachary active in productive ways, teaching him, showing him new things, I had always found to be key in minimizing spinning activity – and as such, that made for rather long days. Although I would have to watch spinning issues, I knew K’NEX would nevertheless be a new, intriguing and fascinating toy for Zachary.

For children with autism, K’NEX provided the allure of completing the puzzle – of breaking the code to figuring out “how things fit together”. They involved motor functions and perhaps most important of all, the flexibility to teach a child with autism that there can be more than one way to make things “fit together” and still have fun. K’NEX allowed for that “in-between” situation by providing a flexible tool that could be used in countless ways to create countless fun toys and that helped to move children with autism away from the need for sameness. In addition, the fact that there were “so many” pieces made it so that a child with autism would most likely get tired before he could use “all” the pieces... and that again, allowed for that “in between” situation – allowing the child to stop the project before all pieces were made “part of it”.

In the past, I had become very aware of the fact that Zachary had wanted to “use all the parts” – all the pieces to the puzzle, all the play dough, all the blocks, all the Tinker toys, etc. With K’NEX, there were so many pieces to use that it was almost impossible for a child to use them all in one sitting – and that for parents working with children who have autism – was golden in that it forced the child to come to terms with the “incomplete” in the sense that all the pieces were not being used – and that it was ok to “just leave some and move on”!

Just as golden as the toy itself, however, would be Zachary's reaction when he would find this bin of K'NEX in the morning. Until this visit, I had not particularly noticed Matthew's huge box of K'NEX in his bedroom closet – and neither had Zachary. It was really at Andrew's house that Zachary had seen K'NEX toys on previous visits but had only briefly played with them since his cousin Andrew also had an autism spectrum disorder and K'NEX were Andrew's coveted treasures – toys that had the allure of a puzzle, but the flexibility to create untold variations of wonderful “things”.

Many of Andrew's creations had indeed involved putting together thousands of pieces - at times with special little motors to make the toys actually “work”. I certainly understood why Andrew was so protective of his creations. They had required a great deal of time and effort to put together, and the last thing Andrew wanted was to have his five and a half year old cousin breaking his stuff apart – and I certainly knew that if Zachary removed even just one piece from Andrew's masterful creations, in all likelihood, he would go on to disassemble the entire structure Andrew had created – leaving behind a bunch of K'NEX scattered throughout the room and a shattered Andrew as well.

Although Andrew, now twelve and diagnosed as PDD (Pervasive Developmental Disorder) usually prepared for a visit from Zachary by locking his bedroom and hiding as many of his own toys as possible, during this visit, Andrew had been much more open to sharing his things with Zachary. There were still some of Andrew's many marvelous creations that were “off limits”, but, during this trip, Andrew had truly made an effort to be “nicer” to his cousin and had brought out a box of “extra” K'NEX for Zachary to play with. And so, on this particular trip to Canada, Zachary truly had the joy of actually manipulating and discovering K'NEX for the first time!

Since Andrew also suffered from autism, his mother and I had shared many a story, many a cry and many a laugh as we went through the trials of autism together. The trials always seemed to surface more during those times when our family would visit hers. Experience had taught us that having two children with autism in one house could make the situation ten times worse. Andrew and Zachary just seemed to know exactly how to upset one another. A great deal of that surely had to do with the fact that they had the same interests and, as such, wanted to play with the same toys – at the same time – usually resulting in a rather stressful situation. It was a given that if one child showed interest anything, in a matter of seconds, the other would be there wanting to “take over” the coveted object.

Yet, along with the frustration, there were also laughs. Christine and I had become keenly aware of the fact that at times, Andrew liked to show off his toys and then parade them in front of Zachary. He would show them off to me as I admired the ingenuity and work behind what he had created and then at times, he went on to parade them in front of Zachary. Christine and I knew that – at times – this was done to make Zachary envious. After resolving “the tensions” between the boys, Christine and I would often sit and chuckle as we discussed the behavior of our children. Since both boys had autism, we knew they loved the same things and that could be either a blessing or a disaster depending on the situation and the events of that particular day, that particular hour, that particular minute, that particular second. With children who have autism, parents quickly learned to spring into action or adapt on a moment's notice.

My sister-in-law, Christine, her husband David, and their children, Andrew and Allison, had truly been a blessing in my life. As difficult as visits could be, these times allowed time for sharing experiences and gave me an insight into what may be coming for Zachary down the road. Christine was a keen observer and completely devoted to her children. Under her care, Andrew had truly thrived since being pulled out of the public school system.

In school, Andrew, like so many children with autism, was being left behind. There often was no curriculum specifically for children with autism and in all honesty, it truly appeared “the system” simply had very little idea as to what worked with these children. Suggestions Christine had made, involving “role playing”, something I now also saw as critical for children with autism, had been completely ignored. Yet, as readers will come to see as they go through this book, Christine had been 100% correct in her assessment of what had been needed for her son – and what may be needed for many more children with autism.

But, on this particular morning, there would be no frustration, no tension between Andrew and Zachary. Andrew was at his house and we were staying with my in-laws. Matthew, a normal boy, age 12, had also been visiting my in-laws – his grandparents – and Matthew, like Andrew, was also a K’NEX pro!

The night before, I had gone to the store to buy two sets of K’NEX for Zachary. I had left one set, a bin with 250 pieces, in the living room, on the floor, so that Zachary would find it almost as soon as he awoke. That night, as I went to bed, I could picture the great joy Zachary would experience upon finding a bin of K’NEX first thing in the morning – just for him!

As was usually the case, Zachary was the last one to get up in the morning. As he came into the living room, I said, “Look Zachary, a present”. I had not wrapped the bin of K’NEX – it was just there – a nice size bin – right smack in the middle of the living room. When Zachary heard “a present”, he immediately responded, “Christmas”. I then answered, “No. It’s not Christmas. This is just an everyday present – because you are such a good boy”.

I knew immediately why Zachary had responded “Christmas”. As I explained in my second book, *Breaking The Code To Remove The Shackles Of Autism: When The Parts Are Not Understood And The Whole Is Lost!*, children with autism live “by reference” and to Zachary, the word “present” was associated with “Christmas”. I did not bother to go into more of an explanation for Zachary in terms of why it was not Christmas today. I just wanted him to enjoy the moment. In a matter of seconds, the bin was opened, turned over – allowing the 250 pieces to fall onto the carpet, and the “manual” was being examined closely.

Zachary could now read pretty well any word as long as he knew the phonics. In no time at all, he had found the model he wanted replicated – the “jungle truck”. Of course, he had picked one of the harder models to make. There were 22 models provided in the manual. For the non-K’NEX expert - a person such as myself, such a request to replicate “the jungle truck” would almost send one into complete despair. I knew it would take me hours to make this thing. I just did not have that “engineering talent” in me. But, luckily for me, there was Matthew!



In no time at all, Matthew was busily putting together “the jungle truck” for Zachary. Zachary anxiously sat by, watching as the jungle truck was assembled. It must have taken Matthew – a K’NEX pro in my eyes – close to half an hour to make that jungle truck for Zachary. He had made it before and so, experience had paid off. What a relief! Zachary had his truck to play with and was thrilled beyond belief – and I was relieved beyond belief that I had not had to make it for him!

My in-laws lived on a farm. Matthew and Anika had already eaten breakfast and so, they were quickly off to see if the hens had laid any eggs and to see the eight new puppies in the barn. Meanwhile, Zachary was in the house with the rest of us. Zachary played with his jungle truck for about forty minutes, pushing it up and down the hallways and into the bedrooms and back. At times, Zachary would lie down and watch the wheels turn as he pushed his truck. Other times, he would just get either in front or behind it and push it. Soon, the motion of the wheels finally got the better of him. He wanted to “spin them”. Before anyone realized it, he had pulled apart the jungle truck – that masterful creation – and had the wheels spinning on one of the rods as he pushed the outer part of the wheels with his fingers to make them spin faster.

Zachary’s spinning activities had gone down significantly compared to what they used to be, but, if left alone or idle, it was still an activity that lured him back into autism. The intensity and duration of the spinning was not nearly what it used to be, but even spinning for a few seconds or minutes would have required the destruction of that beautiful jungle truck Matthew had so skillfully created. Upon seeing the demolished truck, my heart sank. As was so often the case, when something was “destroyed” or pulled apart, Zachary had to almost completely “destroy” or “pull apart”. What had once been a great “jungle truck” was now a scattered bunch of pieces. Of course, I also knew what was coming next – the request to “make a jungle truck” – again!

I had learned a long time ago that Zachary often did something before realizing the consequences of those actions. His urge to spin a wheel had been strong enough to make him pull the wheels off the truck and then, came the inevitable need to destroy the entire thing – that all or none obsession I had so often observed in Zachary – and the inflexibility to allow for the “in-between”. Zachary could not have simply pulled off the wheels to spin – once one piece had been removed, the entire thing would have to be ripped apart. Again, I would have to show Zachary that you could just take “one piece” and leave the rest almost intact. It was the constant need to show Zachary the “in-between” situation. He still had not been able to generalize what he had learned in other situations, with other toys. This was a new thing and he would have to be shown – again – that the “in between”, the “not all or none” was ok, too! I knew I could easily enough show him that by showing him “a broken truck” with just a few missing pieces.

Providing a “broken truck” label would make the partial truck an entity in and of itself – and that would be ok. Yet, for now, the jungle truck had been destroyed and there was Zachary, asking me to “fix it” as he said: “Make a jungle truck, mom”.

Well, I knew that I did not have the patience to even begin to attempt such a complicated model – at least not for my first experience with K’NEX. I needed to start with the simplest model, something flat, on the floor, with just a few pieces. Yet, here was Zachary, asking me to make one of the most complicated models in the entire manual. When faced with this situation, it did

not take me very long to find the answer – Matthew! I would just have to explain to him that Zachary destroyed the truck and beg him to make it again! Actually, I decided to make Zachary ask him. In the next minute or so, Matthew and Anika had come back into the house to bring the eggs they had found. I told Zachary, “Go say to Matthew: ‘Matthew, can you make the jungle truck – I’m begging you!’”. I had learned long ago that I had to literally tell Zachary “what to say” to provide for him a “reference” for a particular situation.

In the past, I had told Zachary that if he really wanted something from me, all he had to do was say: “I love you, mom” and I’d probably give it to him. Well, Zachary obviously remembered that, and, in this case, had applied the lesson to a new situation. He walked down the hall with tears in his eyes because mommy had told him she could not possibly make this jungle truck. He went over to Matthew and instead of saying the sentence I had instructed him to say, Zachary said: “Matthew, I love you” as tears rolled down his little cheeks. Zachary then proceeded to ask Matthew to make the jungle truck in the manner I had instructed him to ask. My father-in-law had just come in and heard Zachary say this to Matthew although he had not heard my conversation with Zachary. All my father-in-law saw was Zachary attempting to manipulate his cousin with an “I love you” prior to the request. So, to my father-in-law, this was a rather hilarious thing to witness. Yet, I knew exactly why Zachary had preceded his request with a “Matthew, I love you”.

As I had explained in my second book, I knew that Zachary lived by reference. In this case, Zachary had simply generalized what had worked in the past, an “I love you, ...” to get what he wanted from someone else – in this case, Matthew.

Matthew was a very kind child. He was easily persuaded to make the jungle truck – again! It was as he completed the truck for the second time that Zachary had uttered the sentence, “Put those yellow wheels back in their place!” I could tell Matthew knew Zachary would probably destroy the truck again shortly – hence the desperation I sensed in Matthew as he heard this sentence from Zachary - a sentence that had been as music to my ears. This sentence that seemed to arouse despair and suspicion of a near destruction in Matthew, I recognized as something totally new – a sentence created by Zachary completely on his own – eight words put together to express exactly what he wanted, in a perfectly correct sentence, in a perfectly correct situation, and perfectly correct context. I was thrilled as I repeated the sentence and counted the number of words on my hands – Put – those – yellow – wheels – back – in – their – place! - eight words – a perfect eight-word sentence – so perfect in absolutely every way!

I had heard some of Zachary’s “perfect sentences” before, yet each one was still so new to me that if they sounded “kind of long”, I always counted the number of words on my fingers. I was not surprised by the fact that Zachary could utter such a beautiful, such a perfect sentence, yet, as I savored what Zachary had just said, another sentence was heard. This time, it was my mother-in-law saying: “What? What did he say?” She had never heard more than two or three words out of Zachary at once and she stood there - almost in disbelief. I knew she was absolutely thrilled.

I had often told my in-laws that Zachary’s progress was coming along nicely. The problem was that unless you were around for a while, you probably would not necessarily realize that.

Zachary was not a big talker by any means. He knew how to communicate, and could do so quite well if he had to, but, unless it was something he really wanted, you could wait quite a while to hear those perfect sentences that were now becoming more common in the life of our family.

“Put those yellow wheels back in their place!” Eight words - so precious to me, so unbelievable to my mother-in-law and so less than impressive to my nephew as he anticipated another soon to occur destruction of his masterful creation. I finally knew that Zachary was now well on his way to breaking the code to more advanced language – actual conversation. Things were finally coming along – slowly – but, yet, we were finally moving into to the realm of actual conversation. Zachary had come so very far in just three years – and what a long, but rewarding, three years it had been!

## Looking Back...

March 22<sup>nd</sup>, 2000... the date I had first come to realize that my son had autism. That night - it seemed so long ago - I had stayed up late researching autism in an attempt to prove my husband wrong - a husband who, along with his sister, had started to suspect our son had autism. Time was truly amazing in how it worked in memory formation. Some things that happened twenty years ago seemed like just yesterday, yet, in other instances, things that had happened only a few years ago seemed like so, so very, very, very, long ago.

As difficult as the last three years had been, they had also been rewarding. I was finally getting my son back and that was something I now hoped for all families of children with autism. Back then - I had so despaired – facing such a huge unknown. Now, I had more hope than ever for Zachary, because I finally understood him. Would he recover completely? No. I knew that – there was no doubt in my mind that Zachary had actual brain damage. Could he get much better – absolutely!

I knew there were organizations “looking for a cure”... but, by now, I knew there would be “no cure”. In my opinion, that was but a deception – and the offering of a false hope to families. There would be no pill or process or procedure that would “cure” Zachary – and I knew that. A “cure” implied there was something you could somehow “fix”. But, there was so much wrong with these children, in terms of overall brain processing, their metabolism, their immune system, etc., that by now, the realities of autism had set in a long, long time ago for me. There would be no “magic cure” to brain damage – and damage had very much been documented in these children. All I could do now was to understand “how” Zachary’s brain worked in order to best help him. Although I knew there would be “no cure” for Zachary, I also knew he had come such a long way – and I had no doubt he could go much, much further still. Each and every day showed me that much greater achievements were now possible for Zachary.

Three years... I had come to learn so much in three years. This was now the fourth book on I sat down to write on my family’s journey in order to help other families understand “autism”. My sister-in-law, Christine, had always been such a pillar for me. Christine had also learned so many things from the “school of hard knocks” – the world of a mother living daily - with autism. Given Andrew was older, I had been given the opportunity to see a little of “what to expect down the road” via Christine’s experiences with Andrew and that had been a huge blessing in so many instances. It was because of that – the tremendous help that could come in knowing “what to expect” – that I had so wanted to share our family’s journey with autism with other families. Life with autism was so very difficult that the wheel should not be reinvented over and over and over again. All families should not have to learn everything “the hard way”, and as such, if my family’s journey could help another family – another child with autism – then, to me, it was well worth the effort to sit down and share our story.

I knew all too well the pain involved in learning your child had autism – that stabbing feeling in your chest that made you feel as though you were going to die as the realization set in that you could potentially, slowly and painfully lose your child to his own world – forever. So many families were now facing autism. So many families were now looking for help – looking for answers. There was barely time to grieve when you were the parent of an autistic child.

Indeed, you had to literally “hit the ground running”... there was so much to do... so much to learn as parents attempted to beat the clock and help their children as much as they could - as early as they could. Only the parent of a child with autism could possibly understand the pain of having a child facing an entire life with autism. Only the parent of a child with autism could possibly understand the hope that came with knowing that something could be done to help so many of these children get out of “their world” and back into a world that included mom and/or dad, a sister and/or brother, a grandma and/or grampa.

The road certainly was long – of that, there was no doubt – but it certainly could also be very, very rewarding. Each “I love you, mom”, each hug, each word, each glance, each everything – no matter how small – was now so very cherished. Nothing was taken for granted any more. What a very long three years it had been... a long, grueling, draining, yet, so rewarding, three years. Back then, there had been such desperation – but now, there was such hope and so much joy.

As I looked back, there was no denying that the initial “breaking through the shell” had been so key in getting Zachary back. Sure, he still had a lot to overcome, but at least, now, he was part of my world again and that was what I hoped for so many other families who had children with autism. As I thought back about “what had worked for Zachary”, so much now made sense to me when it came to Zachary’s development – especially his language development and his ability to communicate and it was this area I specifically wanted to address in this text – communication – taking a look at not only what had worked “for us” but also a look at where to go from here based on what I had now learned over the last three years.

## Brain Structure And Function Overview...

In both my second and third books, I had discussed how so much in Zachary could be understood based on brain structure and function alone – **if I assumed little or no communication among the various parts of the brain! Over time, I had no doubt that some of Zachary’s neural connections among the various parts of the brain had started to “rebuild”, however, there was in my opinion, absolutely no denying that assuming little or no communication among the various parts of the brain seemed to explain a great deal of what we saw in children with autism.**

As mentioned in my third book, one of the major keys to “rebuilding” those broken neural connections absolutely involved the computer since almost the entire brain appeared to be activated while on the computer. In my opinion, we had made a very grave error in attempting to teach these children – we had assumed they could only handle so much sensory input at once in the learning situation, and as such, we provided things like “a flashcard” – one at a time – stimulating only limited parts of the brain – when the key, in my opinion, was truly in stimulating as much of the brain as possible – at once.

If you thought about that, it made perfect sense. It all went back to the “use it or lose it” theory. **The more you used your brain, the more neural connections it appeared to form and as such, the key to rebuilding severed connections had to lie in activating as much of the brain as possible – at once! This was why a computer, I now believed, was a medical necessity for children suffering from autism!**

The following was the “basic brain overview” chart I had provided in both my second and third books. I truly believed it was critical that parents come to memorize these simple charts because, within this information were the keys not only to teaching our children and understanding them, but also the keys to dealing with behavioral problems and/or “meltdowns”. For more on this issue, again, I encouraged all parents to read the books I had previously written. There was simply too much information to repeat here and I wanted to keep this book focused more on matters of “communication”.

The human brain had two hemispheres (left and right) joined by a mass of fibers in the middle, known as the corpus callosum. This mass of fibers, the corpus callosum, allowed the two hemispheres to speak to one another. The two hemispheres of the human brain were further subdivided into regions called “lobes”. Specifically, the brain had four lobes:

<b>Frontal Lobe</b>	<b>Temporal Lobe</b>	<b>Parietal Lobe</b>	<b>Occipital Lobe</b>
<b>Location</b>	<b>Location</b>	<b>Location</b>	<b>Location</b>
most anterior, below forehead)	side of head, above the ears	at the back and top of the head	most posterior, back of the head
<b>Function</b>	<b>Function</b>	<b>Function</b>	<b>Function</b>
motor activity	auditory and olfactory processing (hearing and smell)	somatosensory processing	visual processing
motor planning and execution	memory acquisition	spatial processing	
activity in response to environment	emotion	visual attention	
memory as it related to habits and other motor activities	understanding of language	touch perception	
olfactory cortex	voice recognition	manipulation of objects	
language production	face recognition	goal directed movement	
higher functioning (i.e., concept of self, imagination, etc.)	categorization of objects	3 dimension identification	
controls emotional response	some visual perception	<b>integration of sensory information that allows for the understanding of single concepts (integration of the parts into the whole)</b>	
assigns meaning to words (i.e., word associations)	ability to distinguish between truth and a lie		

Such were the basic functions within these major sections of the brain. The following provided a basic view of what happened if damage occurred to one of these areas.

Science now knew a great deal in terms of what we saw if specific parts of the brain were damaged. The following provided a brief summary of this information.

<b><u>If Frontal Lobe damaged - results in</u></b>	<b><u>If Temporal Lobe damaged - results in</u></b>	<b><u>If Parietal Lobe damaged – results in</u></b>	<b><u>If Occipital Lobe damaged - results in</u></b>
paralysis	selective attention in terms of sight and sound	inability to recognize self	problems with vision in terms of
difficulty problem solving and sequencing	difficulty understanding spoken word	inability to attend to more than one object	identifying colors
inability to produce/express language	issues with interest in sexual behavior	lack of awareness of body parts and/or surroundings (somatosensory issues)	locating of objects in one’s environment
lack of flexibility or spontaneity	short term memory loss and interference with long term memory	difficulty in focusing visual attention	illusions – including hallucinations
persistence in thoughts (i.e., obsessive – compulsive)	emotional issues (i.e., increased aggression)	reading difficulty	inability to recognize words (issues with reading/ writing, recognition of symbols/drawings etc.)
inability to focus or attend to one thing at a time (attention deficit)	difficulty in face recognition	difficulty with spatial processing (i.e., math)	difficulty with objects in motion
changes in social behavior	categorization issues	difficulty with eye-hand coordination and/or drawing of objects	
variability in mood/emotions	persistent talking if damage to right lobe	difficulty differentiating left from right	
		difficulty locating words in terms of writing	
		difficulty with associations (i.e., naming of objects)	

Although I would not attempt to cover all parts of the brain, there were a few other key areas that also helped to explain so much.



Other Key Parts To The Brain That Resided **Outside Of The 4 Lobes** Included:

<b>Amygdale (part of “limbic system)</b>	Involved in the processing of emotions (perceiving emotions in others)
<b>Basal Ganglia</b>	Involved in the regulation of movement and the learning of skills, controlled intensity of mental activity, timekeeper, conscious and subconscious task sequencing
Brain Stem	Located in the upper, back neck area and responsible for “life functions” including heart rate, breathing, digestion, swallowing, reflexes to sight/sound, regulation of body temperature via sweating (autonomic nervous system), blood pressure, alertness levels, sleep, balance (vestibular issues)
<b>Cerebellum</b>	Motor coordination and motor learning, some memory for motor reflex functions. Also known to be involved in <b>coordination</b> of higher executive functions, language and emotions, tracking of moving objects
<b>Corpus Callosum</b>	Major link between the left and right hemisphere - allowed the two hemispheres to communicate
<b>Hippocampus (part of the “limbic system)</b>	Involved in long term memory formation (damage here would prevent one from making “new memories”)
Hypothalamus	Maintained body temperature, etc.
Medulla	One of many parts of the brain stem involved in control of “life functions” of breathing, heart rate, etc.
Midbrain	Visuomotor functions, visual reflexes, auditory relays, motor coordination
<b>Pons</b>	Auditory and vestibular functions (balance), sensory and motor. Area of the brainstem between the medulla and the midbrain, that linked the medulla and the thalamus!
Spinal Cord	Input-output of sensory information to/from the central nervous system (brain and spinal cord) and the peripheral nervous system (everything else outside of central nervous system)
<b>Thalamus</b>	Acted as a “gateway”. Sent information to specific parts of the cerebrum and controlled information flow to cerebral cortex (the 4 lobes). A gateway between sensory (except olfactory) or motor neurons in the peripheral nervous system (anything outside the brain and spinal cord) and the central nervous system (brain and spinal cord)
<b>CNS = central nervous system</b>	Included the brain and spinal cord only
<b>PNS = peripheral nervous system</b>	Included those parts of the nervous system not included in the CNS.

## Common Ground...

In order to understand the discussion in this text, I wanted to ensure that all readers had a “common ground” in terms of the basic understandings I had discussed in previous books.

I believed there were many, many issues that played into autism. In my opinion, based on the University of Calgary experiment showing neural degeneration due to mercury exposure, there simply could be no denying that mercury played a definite role in autism. This video had clearly indicated that **within about 40 minutes after exposure to mercury, neurons in this experiment shrank to approximately half their original size, completely devastated and stripped of their outer coating by the mercury and then, according to the scientists, these neurons went on to form neurofibrillary tangles (a “hallmark” of Alzheimer’s).**

Furthermore, the scientists explained that future growth from affected neurons was also significantly impaired. This, of course, fit very much in line with my belief that in children with autism, there was little or no communication among the various parts of the brain. In my opinion, based on what I had come to see in my own son and from what I had come to understand of brain structure and function, it truly appeared connections within the major parts of the brain had simply been “severed” or destroyed.

I strongly encouraged all parents of children with autism to find a way to view this video. It was truly an eye opener!

The video showing neural degeneration as a result of mercury exposure could be viewed online by going directly to the following site:

[http://movies.commonswest.ualgary.ca/showcase/curtains.php?src=/mercury/Lor2\\_QTS\\_300kb\\_QD.mov&screenwidth=320&screenheight=256](http://movies.commonswest.ualgary.ca/showcase/curtains.php?src=/mercury/Lor2_QTS_300kb_QD.mov&screenwidth=320&screenheight=256). A link to this video was also provided on my website, <http://www.autismhelpforyou.com>.

The result of this experiment were published in the following: ***Leong CCW, Naweed IS, Lorscheiderae FL, Retrograde degeneration of neurite membrane structural integrity of nerve growth cones following in vitro exposure to mercury, published in NeuroReport Volume 12, Number 4, 26th of March 2001, pages: 0733-0737.***

Those interested in reading more on this subject could also do so by going to: <http://www.ualgary.ca/~gauntlet/eg/news/stories/20010329/news05.html>.

The body had a difficult time getting rid of mercury – a substance known to lodge in the brain and other major organs. **Mercury, once in major organs like the brain, had a half-life of 20 years, meaning that it would take twenty years for half of the molecules to decay.** Once it entered the body, it was pretty well there to stay – there to create more damage - given the body had no good way to get rid of this toxin.

Although thimerosal (mercury) had been used as a preservative in vaccines since the 1930s, it was only in 1999 that the FDA was forced by a Congressional mandate to disclose ***how much***

mercury there really was in vaccines. Upon mercury content information being disclosed, needless to say, many parents, professionals and government personnel alike became, justifiably, gravely concerned over the fact that for years *infants* had been *routinely given 25 to 50 times more mercury than considered safe by US Environment Protection Agency standards.* *Government officials, scientists and parents were now realizing that by age two, children, via vaccinations, could have been exposed to up to 100 times what had been considered safe levels of mercury by the EPA.*

*Although publicly, the CDC continued to state there was no link between vaccines and neurological disorders, behind closed-door meetings, discussions from top members of the CDC and others involved in vaccination programs clearly indicated otherwise.*

*“If you tell a lie long enough, loud enough and often enough, the people will believe it.”  
Adolf Hitler*

So many times, in trying to understand “issues of autism” I had come to the realization that – often – the answer was not in “what was there” – but, “in what had been missing”. If there were some pieces to this puzzle that had been missing, certainly, the “Simpsonwood meeting” had helped to provide some of those pieces. Information from the Simpsonwood meeting was supposed to have been released to the public over three years ago. In this meeting, the CDC clearly acknowledged it knew for a fact it had a problem with thimerosal/vaccines and neurodegeneration... and yet, to this day, the CDC’s public stance was that “there existed no proof of any link between the two”. All parents saw from the CDC – was denial – and now, with parents having the CDC Simpsonwood meeting transcripts in hand – there could be no denying that this denial was in actuality more than simple denial – it now amounted, quite frankly – to lies!

Below were but a few quotes from a meeting now known in the autism community as “The Simpsonwood Meeting” – a meeting convened by the CDC to discuss matters of mercury as they related to vaccines. Approximately fifty (50) persons attended this meeting, including Walter Orenstein, M.D. CDC’s Director, National Immunization Program. A copy of this report, now well circulated in the autism community, was available on many autism related websites, including mine.

This report had been given to two groups – the organization of the US Autism Ambassador, Autism Awakening (<http://www.autismawakening.com>), as well as the organization known as SafeMinds (<http://www.safeminds.org/>). Upon reading this report, the US Autism Ambassador, LD Wedewer, immediately determined this report’s contents justified providing this information to Dan Burton and The Committee For Government Reform as official, written testimony submitted on behalf of the public for the December 10<sup>th</sup>, 2002 Government Reform Hearings on vaccinations. As such, this report was now considered “public record” and it certainly had become a well-discussed issue in the autism community.

**Dr. Weil, pg. 24:** “One, up until this last discussion we have been talking about chronic exposure. I think it’s clear to me anyway that we are talking about a problem that is probably more related to bolus acute exposures, and we also need to know that the migration problems and some of the other developmental problems in the central nervous system go on for quite a period after birth. But from all of the other studies of toxic substances, the earlier you work with the central nervous system, the more likely you are to run into a sensitive period for one of these effects, so that *moving from one month or one day of birth to six months of birth changes enormously the potential for toxicity. There are just a host of neurodevelopmental data that would suggest that we’ve got a serious problem. The earlier we go, the more serious the problem.*”

*“The second point I could make is that in relationship to aluminum, being a nephrologist for a long time, the potential for aluminum and central nervous system toxicity was established by dialysis data. To think there isn’t some possible problem here is unreal.”*

**Dr. Verstraeten, pg. 40:** “...we have found *statistically significant relationships between the exposure and outcomes for these different exposures and outcomes.* First, for two months of age, an unspecified developmental delay, which has its own specific ICD9 code. Exposure at three months of age, Tics. Exposure at six months of age, an attention deficit disorder. Exposure at one, three and six months of age, language and speech delays which are two separate ICD9 codes. *Exposures at one, three and six months of age, the entire category of neurodevelopmental delays, which includes all of these plus a number of other disorders.*”

**Dr. Bernier, pg. 113:** "We have asked you to *keep this information confidential.* We do have a plan for discussing these data at the upcoming meeting of the Advisory Committee of Immunization Practices on June 21 and June 22. At that time *CDC plans to make a public release of this information,* so I think it would serve all of our interests best if we could continue to consider these data. The ACIP work group will be considering also. If we could consider these data in a certain protected environment. So we are asking people who have a great job protecting this information up until now, to continue to do that until the time of the ACIP meeting. So to basically consider this embargoed information.

**Note:** *If this information was supposed to be released to the public three years ago, where was it? To my knowledge, all we saw from the CDC, to this day, was denial when it came to any link relating to vaccines and neurological damage!*

**Dr. Keller, pgs. 116 & 118:** "...we know the developing neurologic system is more sensitive than one that is fully developed..."

**Dr. Verstraeten, pg. 161:** "Personally, I have *three hypotheses.* My *first* hypothesis is it is *parental bias.* The children that are more likely to be vaccinated are more likely to be picked and diagnosed. *Second* hypothesis, *I don't know.* There is a bias that I have not recognized, and nobody has yet told me about it. *Third hypothesis. It's true, it's Thimerosal.* Those are my hypotheses."

Note: In other words, what this was saying was 1) statistics are skewed and so, this was “really not a problem”, the issue was simply one of “skewed statistics” – implying parents were making the problem appear “bigger than it really was” and so, parents “made it up” 2) either we at the CDC made it up, or 3) it’s true - it is thimerosal. Well, as a parent of a child with autism, all I could say was good luck proving hypothesis 1) or 2) – and, that, appeared to leave only hypothesis 3).

**Dr. Verstraeten, pg. 162:** "When I saw this, and I went back through the literature, I was actually stunned by what I saw because I thought it is plausible. First of all there is the Faeroe study, which I think people have dismissed too easily, and there is a new article in the same Journal that was presented here, the Journal of Pediatrics, where they have looked at PCB. They have looked at other contaminants in seafood and they have adjusted for that, and still mercury comes out. That is one point. Another point is that in many of the studies with animals, it turned out that there is quite a different result depending on the dose of mercury. Depending on the route of exposure and depending on the age at which the animals, it turned out that there is quite a different result depending on the dose of mercury. Depending on the route of exposure and depending on the age at which the animals were exposed. Now, I don't know how much you can extrapolate that from animals to humans, but that tells me mercury at one month of age is not the same as mercury at three months, at 12 months, prenatal mercury, later mercury. There is a whole range of plausible outcomes from mercury. On top of that, I think that we cannot so easily compare the U.S. population to Faeroe or Seychelles populations. We have different mean levels of exposure. We are comparing high to high in the Seychelles, high to high in the Faeroe and low to low in the U.S., so I am not sure how easily you can transpose one finding to another one. So basically to me that leaves all the options open, and that means I can not exclude such a possible effect."

This next comment was my personal favorite...

**Dr. Johnson, pg. 198:** "This association leads me to favor a recommendation that infants up to two years old not be immunized with Thimerosal containing vaccines if suitable alternative preparations are available. I do not believe the diagnoses justifies compensation in the Vaccine Compensation Program at this point. I deal with causality, it seems pretty clear to me that the data are not sufficient one way or the other. My gut feeling? It worries me enough. Forgive this personal comment, but I got called out a eight o'clock for an emergency call and my daughter-in-law delivered a son by C-section. Our first male in the line of the next generation, and I do not want that grandson to get a Thimerosal containing vaccine until we know better what is going on. It will probably take a long time. In the meantime, and I know there are probably implications for this internationally, but in the meantime I think I want that grandson to only be given Thimerosal-free vaccines."

Note: This comment included “this association” – as such, this doctor was clearly acknowledging his personal belief that there indeed existed “an association” based on the data presented.

What this was telling me was that persons who were privy to this information were choosing not to have their “lineage” immunized with these mercury-laced vaccines, but they were perfectly

fine with allowing my child – and thousands more each day - to get those mercury-laced immunizations in spite of their concerns with “this association”.

**Dr. Weil, pg. 207:** "*The number of dose related relationships are linear and statistically significant. You can play with this all you want. They are linear. They are statistically significant.* The positive relationships are those that one might expect from the Faroe Islands studies. They are also related to those data we do have on experimental animal data and similar to the neurodevelopmental tox data on other substances, so that I think you can't accept that this is out of the ordinary. It isn't out of the ordinary."

In other words... “Houston... we have a problem!”... or should that be “Washington... we have a problem”... but, it looked like they “already very much knew that”!

**Dr. Weil, pg. 208:** "The rise in the frequency of neurobehavioral disorders whether it is ascertainment or real, is not too bad. It is much too graphic. *We don't see that kind of genetic change in 30 years.*"

In other words... you can not explain these statistics by “genetics”!

**Dr. Caserta, pg. 234:** "One of the things I learned at the Aluminum Conference in Puerto Rico that was tied into the metal lines in biology and medicine that I never really understood before, is the interactive effect of different metals when they are together in the same organism. It is not the same as when they are alone, and *I think it would be foolish for us not to include aluminum as part of our thinking with this.*"

Given aluminum was a known gene mutant, I, too, would very much agree with that statement!

Note that both aluminum and formaldehyde were both known to impact cell development and as such, they were both known gene mutants – and both – were very much found in vaccines!

As I had stated time and time again, it certainly seemed to me that if you put known gene mutants in vaccines, you should expect to see mutations! Perhaps science experienced so much difficulty “moving forward” in terms of medicine because mutations we were finding were being caused by such “gene mutants” as opposed to by the disorders themselves. Could that possibly explain why so many of the mutations we found in medicine still did not appear to provide “the answers” science needed to move forward in solving so many medical mysteries and why in spite of mutations found, the cause to so many disorders was often still listed as “cause unknown”!

**Dr. Clements, pg 247- 249:** "I am really concerned that we have taken off like a boat going down one arm of the mangrove swamp at high speed, when in fact there was not enough discussion really early on about which was the boat should go at all. And I really want to risk offending everyone in the room by saying that *perhaps this study should not have been done at all, because the outcome of it could have, to some extent, been predicted, and we have all reached this point now where we are left hanging,* even though I hear the majority of

consultants say to the Board that they are not convinced there is a causality direct link between Thimerosal and various neurological outcomes."

What this appeared to be saying was that persons involved in vaccination programs had to be very careful not to do studies that would prove parents were correct – after all, it appeared “outcomes could have been predicted”. How very interesting indeed!

**Dr. Clements, pg 247- 249 continued:** " I know how we handle it from here is extremely problematic. The ACIP is going to depend on comments from this group in order to move forward into policy, and I have been advised that whatever I say should not move into the policy area because that is not the point of this meeting. But nonetheless, we know from many experiences in history that the pure scientist has done research because of pure science. But that pure science has resulted in splitting the atom or some other process which is completely beyond the power of the scientists who did the research to control it. And what we have here is people who have, for every best reason in the world, pursued a direction of research. But there is not the point at which the research results have to be handled, and even if this committee decides that there is no association and that information gets out, the work that has been done and through the freedom of information that will be taken by others and will be used in ways beyond the control of this group. And I am very concerned about that as I suspect it already too late to do anything regardless of any professional body and what they say."

This next comment was another one of my favorites... the old “I have objectives to meet so let me proceed blindly even though there are concerns here”!

**Dr. Clements, pg 247- 249 continued:** *"My mandate as I sit here in this group is to make sure at the end of the day the 100,000,000 are immunized with DTP, Hepatitis B and if possible Hib, this year, next year and for many years to come, and that will have to be with Thimerosal containing vaccines unless a miracle occurs and an alternative is found quickly and is tried and found to be safe."*

"So I leave you with the challenge that I am very concerned that this has gotten this far, and that having got this far, how you present in a concerted voice the information to the ACIP in a way they will be able to handle it and not get exposed to the traps which are out there in public relations. My message would be that any other study, and I like the study that has just been described here very much. I think it makes a lot of sense, but it has to be thought through. What are the potential outcomes and how will you handle it? How will it be presented to a public and media that is hungry for selecting the information they want to use for whatever means they in store for them?"

Again, this appeared to be saying, “let us be very careful of what studies we do because they certainly could come back to bite us”!

**Dr. Clements, pg 247- 249 continued:** "...but I wonder how on earth you are going to handle it from here."

Given that now, millions of parents were realizing they had been lied to by the CDC – for at least three years now given the date of this meeting (early June 2000) – and that quite obviously, the CDC knew immature systems were vulnerable to neurological damage from vaccines and yet, no recall of these mercury-laced vaccines occurred and hence, thousands more now faced life with neurological disorders – this certainly was another comment I also agreed with!

The problem appeared to be that we had all simply assumed studies had been done to look into the issue of safety of mercury in vaccines. Yet, once again, the facts showed otherwise.

***Indeed, in the Government Reform Hearings headed by Congressman Dan Burton, in June of 2002, the public discovered that in over eighty years, not once had the government studied the safety of mercury in vaccinations! This was now a matter of public record – a known fact! Most studies for vaccines lasted but a few days to a few weeks - at best.***

Indeed, the new 5 in 1 vaccine for infants had been approved by the FDA based on 30-day studies only, according to FDA transcripts. Note that Dr. Wakefield had raised concerns over the possible interaction of just three (3) viruses in one vaccine – the MMR - and now, children would be given five (5) at once!

As I investigated the issue of thimerosal and vaccines and went over the CDC's transcript that had been generated as a result of the "Simpsonwood Meeting in June of 2000", something else became very, very troubling for me as I carefully went over those "meeting notes".

As I read the complete transcript of the Simpsonwood meeting, discussing the CDC thimerosal study done by Verstraeten, Davis and DeStefano that resulted in the document entitled: Thimerosal VSD Study - Phase I, and having taken at least the basics in statistics, there was something that very much stood out for me when it came to the CDC study looking at the possible link between vaccines and neurodegeneration. That "something" was the fact that the population sample used clearly was **NOT** even close to being representative of children who would have been exposed to vaccines and in all likelihood have gone on to develop autism.

Let me explain the reasons for which, in my opinion, the Thimerosal study by Verstraeten, Davis and DeStefano that resulted in the document entitled: Thimerosal VSD Study - Phase I, used a population that I could only describe as "white washed" and therefore, truly **not** a good sample **to capture the true extent of the potential problem with vaccines.**

The database used was a **computerized** database that looked at **billing data** provided by HMOs., etc.

I knew that in my personal case, this would never have captured my son in the population sample. From what I could understand of this report, it very much looked like billing codes were the primary thing looked at, as were "diagnosis" for things such as ADHD, etc.

In the case of my son, I had taken him to a pediatrician for an initial assessment - and **only a notation was made in his records** that he showed signs of autism. There was obviously nothing



in the billing that would have indicated that his visit to the pediatrician in early April of 2000 was to discuss the possibility of autism with a pediatrician. The reason I knew that for a fact was because Blue Cross Blue Shield ended up calling my husband and I to find out “what that visit was for”.

We had just left corporate America and had also applied for our own insurance via Blue Cross Blue Shield - apart from our employer - and therefore, BCBS wanted to know "the specifics" about this visit for Zachary - as it could very much impact their willingness to insure us - and clearly it did. We had applied for insurance almost six weeks earlier. The normal process was supposed to take approximately two weeks. It had taken close to six weeks because “they were behind” – so we were told.

When I honestly told BCBS that this was a visit to a pediatrician because I suspected autism in my son, within two days, we received the final answer to our request for personal insurance - they could cover everyone - ***except Zachary!***

We replied "thanks, but no thanks" ...

This experience certainly demonstrated several things as they related to the thimerosal study.

1. Given "***billing data***" was used, I very much suspected persons without medical insurance would not have even shown up in “the data” or “population sample” as no data would have gone to an HMO, etc. for billing purposes. It was estimated that 11 - 12% of children in the US did not have health insurance according to US Census data: <http://www.census.gov/Press-Release/www/2002/cb02-127.html>.
2. Unless the billing information provided "something" to indicate the problem was autism or an autism spectrum disorder, again, that information would have been missed. In my case, that would definitely have been true since the doctor had simply put a "hand-written notation" in Zachary's records, and the insurer had to call to find out “what the visit was for” in the first place.

But, there were other reasons for which this population sample, in my opinion, could very, very much underestimate the scope of the problem.

The data used looked at billing codes. It looked at ***billing*** data. Billing data was just that... billing data... and often, it was inaccurate. Having worked with databases in the past, I knew how often codes were simply wrong and/or inaccurate. The simple fact was that “billing” was to “receive funds due” and if a computer did not accept a particular code, often another code resulting in “the same expense” could often be used. Likewise, if a person did not “remember” the correct code, but remembered another “kind of similar” code in terms of the impact to billing, again, that “kind of similar code” could be used. Computers and humans were not infallible, but humans, it seemed, always found “ways around” such problems in order to get “the job done” – in this case “***billing***” – ***with the goal being the receipt of a specific number of dollars.***

You simply could not, in my opinion, use a database ***intended for billing*** to determine the impact of vaccines on children. These data were ***not intended*** for such a study and as such, in my opinion, that in itself, provided for many, many issues in terms of the accuracy of the data itself!

3. Particularly troubling to me, however, was what I saw as "***white washing*** of the population sample" via the ***automatic elimination from the study of specific children***.

Clearly, over 25% of the probable sample was ***eliminated*** from the study. Page 34 of the Simpsonwood meeting transcripts states:

***"... there was quite a large group, about 25%, that we excluded because of congenital or perinatal disorders..."***

The fact that 25% of children appear to experience and/or be born with "some kind of problem" in this nation should be reason enough for concern in my opinion. Add that 25% to the 12% or so of children known to be uninsured, and clearly, ***close to 37% of the "real life" population sample was missing from this study - and those "left over" – could certainly be considered among the "healthiest" in terms of "who" was allowed to participate in the study - hardly representative of the US population given this study itself clearly indicated that 25% of children had some type of problem very early on – problems that certainly could make them more susceptible to vaccine injury! Clearly, 37% of children were not exempted from vaccines – so, why exclude them from this study?***

Again, according to this transcript, "congenital disorders" were excluded. That would have excluded children who had disorders such as Downs Syndrome. Yet a dual diagnosis of DS and autism was "no longer rare" according to work done at the Cleveland Clinic and also as evidenced by the fact that the "dual diagnosis" was discussed as an agenda item at the National Downs Syndrome Society conferences, both past and present. Bonnie Patterson was but one person now addressing this issue and discussing it at this conference on Downs Syndrome [http://www.ndss.org/ndssmedia/pdf/Conference\\_brochure.pdf](http://www.ndss.org/ndssmedia/pdf/Conference_brochure.pdf).

"Perinatal medicine" as defined by an online dictionary was the period started ***from week 28 in gestation to day 28 after birth*** - I quote:

***"The branch of medicine dealing with the foetus and infant during the perinatal period. The perinatal period begins with the twenty-eighth week of gestation and ends twenty-eight days after birth. "*** <http://www.books.md/P/dic/perinatalmedicine.php>.

I can not help but ask: Why had those doing this study "gone back to week 28 of gestation and excluded any child who experienced a problem during pregnancy? Could it be because these children were perhaps most "at risk" for autism and given the CDC really did not want to see "a link", they chose to exclude as many "risks" as possible that would show a link

between autism and vaccines? Why would a study looking at the effects of thimerosal go back to week 28 of gestation in determining who would or would not be included in the population sample?

Week 28 was a critical point in pregnancy... that was when mothers could show signs of gestational diabetes, Rh factor incompatibility, etc. As such, any child of a mother who would have experienced gestational diabetes, or Rh factor incompatibility, any child born with “a problem” or experiencing “a problem during pregnancy” could have been excluded from this study. Note that mothers who experienced Rh factor incompatibility were given a shot at week 28 of gestation (and a shot shortly after the child’s birth) – a Rhogam shot – ***a shot – laced with mercury!*** If these mothers were excluded from this study, in my opinion, this amounted to another “white washing” of the population sample.

Likewise, if indeed children of mothers with gestational diabetes had been excluded, I also had serious concerns with this. My son, I knew, was born “low on glucose” and had to be given that “special little glucose bottle” at birth. This had been a clear sign of a problem from day one!

Mercury was known to impact hormones... and insulin... certainly was a hormone. Insulin was a hormone very much involved in lung development (as explained in book 3) and indeed children of mothers with gestational diabetes were now known to have delays in lung development. Likewise, these children were also known to have a delay in the switch from “alpha-gamma” to “alpha-beta” blood – a switch that normally happened – at week 28 of gestation. Given this switch had to do with the “globin” part of the hemoglobin (blood) and globin was very much a function of the immune system, that, to me, indicated these children could be among the most susceptible to vaccine injury given their even more immature immune system. For more on this issue, I strongly encouraged all parents to read “book 3” entitled Breaking The Code: Putting Pieces In Place! This book was posted in full on my website, <http://www.autismhelpforyou.com>.

Children with “breathing problems” had also been excluded from the study. Yet, again, science had clearly shown that children of mothers with gestational diabetes showed delays in lung development. Of course, given “the blood” and “the lungs” were so closely linked in terms of oxygen exchange, it was not surprising to me to discover that along with the delay in the switch from “alpha-gamma” to “alpha-beta” blood, there was also a delay in lung development in children of mothers with “gestational diabetes”.

Note that I had, personally, ***not*** been diagnosed as having “gestational diabetes”. Could I have been a “borderline case”? I had no way of knowing. Yet, ***the one thing I knew without a doubt was that my son was born with insulin problems and that insulin very much impacted lung development and the immune system when it came to “the blood” and “lungs” of my child.***

Insulin was also very much tied to the digestive process.

Note also another interesting comment... I quote:

*... "the heavier babies in this cohort are more likely to have the outcome, and that is statistically significant..." (p.46 of Simpsonwood transcript).*

That was very interesting to me... heavier babies... hum... Was an insulin problem at play here? My son was very, very heavy/big... always "off the growth charts"... he constantly wanted to eat... so much so, that this was very much discussed with his pediatrician and noted in his chart. Indeed, my pediatrician used to refer to Zachary as - "the moose" – whenever he saw him. That had always irritated me a great deal. Now, as I looked back... I could not help but think about what a fool I had been for having so completely put my faith in “the system”.

Casein/milk proteins had been shown to act as natural opiates in children with autism... certainly helping to explain why children like Zachary wanted to eat constantly - they were getting a "drug high" from their milk!

Yet, again, according to the Simpsonwood meeting, it appears that children who had "feeding problems" were excluded (see p. 98 of Simpsonwood transcripts). Needless to say, there was very little doubt that children who develop autism often had "feeding problems" - as clearly evidenced by overeating, vomiting, diarrhea, etc., in these children. Yet, children with "feeding problems" appeared to - again - have been excluded from the study! Why? What in the world did “feeding problems” have to do with “thimerosal”? It seemed to me that this had been, yet again, another attempt at “white washing” the population sample! Did the CDC suspect that thimerosal impacted insulin and hence resulted in “feeding problems”? I could not help but wonder! Why had children with “feeding problems” been excluded from this study? Zachary certainly did have “feeding problems” as did most children with autism. As such, again, in my eyes, this was yet another attempt at “white washing” the population sample!

Likewise, many children experienced “jaundice” at birth. I had already spoken to several mothers of children on the autism spectrum that recalled their children having “jaundice” when born. Jaundice was another issue discussed in “book 3” and I very much suspected another issue that also very much played into all this. Had these children also been excluded?

Children with “cardiac” or heart problems had also been excluded from the study. Note that my nephew, Andrew, was born with heart problems – and as such, had open-heart surgery at a very young age. Andrew was also, very much on the autism spectrum – another child who would not have been included in such a study.

Yet, also as discussed in “book 3”, insulin was now known to regulate iron in the body and iron was in turn known to regulate insulin levels. Iron, toxic in excessive amounts, was also known to accumulate in all major organs – including the heart! I also now knew prenatal vitamins were loaded with iron and that the body had no good way to “flush” extra iron from the body! Was this why so many pregnant women could not tolerate prenatal vitamins and indeed, often threw them up? Were we making women iron toxic during pregnancy? I very much suspected this was indeed the case and perhaps one of the first dominos in the autism puzzle.

Note that bacteria and viruses also very much “needed iron” to grow and multiply – and that “white matter” in the brain was rich in iron receptors. Not surprising to me, children with

autism had shown that after given the MMR vaccine – a vaccine without mercury – viruses from that vaccine were found in the brain and the gut... exactly where “their food source” resided - another very interesting piece to the puzzle! Again, more on that in “book 3”.

All of these issues now ran through my mind. I knew all of this was somehow all interrelated.

That "little glucose bottle" Zachary had been given at birth because he was "low on glucose" had always bothered me since I had discovered he had autism. Clearly, this was a sign of problems with insulin even though I was not said to have gestational diabetes... a sign from DAY 1.

In discussions with other parents of children with autism, I had also learned some children appeared to have low levels of iron at birth. Given iron and insulin modulated one another... that was not surprising to me (more on that in book 3). Unfortunately, children seen as "anemic" - and hence believed to be low on iron - could be given iron supplements when in fact the problem was not one of "too little iron" but "too much" and thus – more iron – appeared to be exactly what these children did ***not*** need! The following link explained how one could have "iron overload" in spite of appearing to be "anemic".

<http://www.ironoverload.org/anemia.htm>

***Also excluded from the study were infants born prematurely*** because their systems would have been "more susceptible" to vaccines as again, clearly indicated in the Simpsonwood transcripts. It appeared that children who were premature were vaccinated on a different schedule. Yet, Dr. Verstraeten himself stated in the Simpsonwood meeting - I quote:

***"I can see some very premature children also getting vaccinated"... (p. 153 of Simpsonwood transcripts).***

Obviously, these children, being more susceptible in the first place, could very well have gone on to have "an event" that would have increased the statistical significance had they been included in this study! Thus, children who would have been among the "***most susceptible***" to vaccine injury, were excluded from the study, even though, clearly, according to Dr. Verstraeten himself, many very premature were also getting vaccinated... so again, why exclude this group. Clearly, again, this was but another “white washing” of the population sample and the exclusion of these children made it such that, in my opinion, the data, again, were simply not representative of “the real world” population.

Also excluded were infants who died... death and autopsy reports were excluded - even though, clearly, the VAERS database indicated vaccines often played a role in childhood deaths, SIDS, and/or abnormal breathing patterns.

<http://www.909shot.com/Articles/gnssids.htm>

<http://thinktwice.com/sids.htm>

Also excluded were children who had not received 2 polio shots. I did not understand this condition/criteria given the polio vaccine **did not** contain mercury and as such, it should be a “non-issue” in a study that was supposed to be looking at thimerosal... unless the scientists believed this may be a way of seeing if “something else” was the problem - like the polio shot... something that did not have mercury in it.

The authors of the study seemed to indicate that their reason for including these criteria had to do with a variable involving “length of time” in an HMO. Well, certainly, a “start date” and “end date” could have easily been pulled from a computerized database. So, again, why use “polio” at all as a variable in this study. I simply did not see the logic to that.

If a "non-thimerosal" containing shot was going to be included in this study, why was it not the MMR instead of the polio shot because, clearly, parents were associating the MMR with autism also. Thus, why take polio and not look at the MMR instead? Was this another “white washing” of the population sample? Why not a study also looking at the MMR – instead of the polio vaccine?

***Also excluded were children who had received hepatitis B immunoglobulins.*** Note the reason for excluding these children - I quote:

***"Those would be vaccinated for hepatitis B and would have a higher likelihood of the outcomes"...(p. 32 of the Simpsonwood transcripts).***

That exclusion was very troubling to me... it very much appeared to be saying that we specifically excluded these kids because if they had this shot, “they would be more likely to have neurodegeneration... so, let's not include them!”.

Note also that the study underrepresented the effects of Hepatitis B in children because that data was generally not available and as such, the data was very much incomplete in this respect.

Note that Hepatitis B was the first shot usually given to infants... often before they left the hospital... and it certainly did contain mercury and it certainly did appear to cause death in infants according to information in the VAERS database!

<http://www.vaccinationnews.com/DailyNews/2003/July/09/HepatitisBVaccine9.htm>

***Also excluded were children participating in vaccine studies...*** for new vaccines... as indicated by Dr. Gerber's comments at the Simpsonwood meeting - again, I quote:

***"...it seems to me that during the time that this study was done, 1992 - 1997, at least at Northern California Kaiser, there was a substantial number of children involved in vaccine trials. The vaccines that those children would have received would not have shown up in the CPT coding. " Dr. Gerber, p. 232.***

Again, this exclusion was particularly troubling to me. If children were in “vaccine studies” in all likelihood, those vaccines would have gone on to be approved by the FDA and given to “other children”. If these “new vaccines” were part of the problem, by excluding these children in vaccine trials, again, we would have completely “missed” a potentially huge issue.

Note also, that as clearly indicated in the Simpsonwood meeting, many children were simply not old enough yet to be diagnosed! (p. 38 of Simpsonwood transcripts).

There were also issues with codes themselves. For example, a child could be said to be diagnosed with ADHD and then, later "not confirmed". Well, given that ADHD was usually confirmed around age 8 - 10, it would make sense that this "diagnosis" would not have been confirmed... perhaps the doctor was simply indicating that there was a problem. The lack of a "confirmed ADHD diagnosis" did not mean that a problem did not exist anyway – especially given ADHD was diagnosed around age 8 – 10. As such, in my opinion, "lack of confirmation" of a diagnosis of ADHD did *not* equal "lack of a problem or issue" – to me, that simply indicated the doctor saw a problem but perhaps the final diagnosis was still “out there” or coded as “something else”. That certainly did not mean that a problem “did not exist” in the first place.

Note also that unless a mother "raised a concern", children would not have been included in the population... it was often up to the mother to "see the problems" and have the child looked at... and unfortunately, many, many children went quite a while before they were "diagnosed" - as clearly indicated in the Simpsonwood meeting. Again, I quote:

***"There is no routine screening of children, so it is only if the mothers bring their children for a problem that we will be able to pick it up." (p. 49 of Simpsonwood transcript).***

***"I work in the Early Intervention Program and I wish you were right, but in a study that we have done in Michigan, we think that there is less than 40%, probably less than 30%, of the kids who are eligible in terms of delay that are in fact referred for evaluation. Even then, we don't know how many of those are getting treated..." (Dr. Weil, Simpsonwood meeting transcripts, p. 137).***

Also, children who "dropped out of the HMO for some reason" were not included in the study. Could these be children whose parents saw a problem and went to a DAN! (Defeat Autism Now!) doctor, etc. instead? Again, I saw a huge issue with not including children who “appeared to drop out of the HMO or not use their HMO” in the population sample.

As I looked at this "population sample", clearly, in my opinion, there was much too much "white washing" of the initial population included in the study. ***This “final population” was clearly not even remotely representative of the “population” in general.***

As clearly stated by those attending the Simpsonwood meeting - I quote:

***"the kids you choose to let into your analysis can have a great effect on what happens eventually..." (p. 96 of Simpsonwood transcripts)...***

But...

***"As a whole, the group was pretty unanimous, in fact we were unanimous, in saying that additional research is needed." Dr. Stehr-Green, Simpsonwood transcripts, p. 252)***

The Simpsonwood meeting occurred in June of 2000....

Yet...

Note that on November 15 of that same year - 2000 – Dr. Walt Orenstein, Director of the National Immunization Program at the CDC, attended a meeting again, on the safety of vaccines and when the FDA's Dr. Susan S. Ellenberg proposed conducting larger trials, Walt Orenstein clearly indicated he was ***"not in favor of expanded studies"***.

This was not surprising given the concerns raised in Simpsonwood about ***"the study that should never have been done in the first place"*** according to the CDC itself...

***"... so what I will present to you is the study that nobody thought we should do".... (Dr. Verstraeten, Simpsonwood transcripts, p. 31)...***

and what, in my opinion, amounted to nothing more than an incredible attempt at "white-washing" of the original population sample!

The simple fact was, in my opinion, that "if you don't want to see a link between autism and vaccines" the chances were, you would do what you could to make sure "none was seen" ... would you not?

***"I am really concerned that we have taken off like a boat going down one arm of the mangrove swamp at high speed, when in fact there was not enough discussion really early on about which way the boat should go at all. And I really want to risk offending everyone in the room by saying that perhaps this study should not have been done at all, because the outcome of it could have, to some extent, been predicted and we have all reached this point now where we are left hanging, even though I hear the majority of consultants say to the Board that they are not convinced there is a causality direct link between Thimerosal and various neurological outcomes... I wonder how on earth you are going to handle it from here." (Dr. Clements, representing Expanded Program on Immunizations, WHO (World Health Organization), Geneva, Simpsonwood transcripts, p. 247).***

Below was a link regarding this November 2000 meeting in a story done by Reuters, on Thursday, Nov 16th, entitled: FDA, NIH, CDC reconsider system for ensuring vaccine safety, during which Walt Orenstein was asked about "expanded studies"... and stated he was "not in favor of expanded studies"...

[http://archive.mail-list.com/hbv\\_research/msg01771.html](http://archive.mail-list.com/hbv_research/msg01771.html)



How could it be that fifty (50) people could come out of the Simpsonwood meeting stating that more studies were needed, and yet, in this meeting, Dr. Walt Orenstein, Director of the National Immunization Program at the CDC, could state that he was “not in favor of expanded studies”!

Call me crazy... but, as the old saying went... “I smelled a rat...”

In my opinion, there could be no doubt that the CDC Thimerosal study used a very "white washed population"... and still... they received "a signal" of a problem in terms of the correlation between vaccines and neurodegeneration... while using the “most healthy” population sample they could possibly use...

***I suspect had they used a more representative population sample... perhaps that "signal" would have been something more in the order of a - "tornado warning"!***

Clearly, from everything I had come to understand about vaccines, there could be no doubt in my mind that they absolutely played a role in the autism explosion, and I suspected in the explosion of many, many other illnesses as well. Based on what I had read, in my mind, there was simply no denying that mercury absolutely appeared to play a role.

Yet, I also believed there were other factors that very much played into this. Aluminum, according to another “behind closed doors meeting” appeared to be just as dangerous as mercury. ***Aluminum was a known gene mutant.*** More important, however, were the following comments from Dr. Boyd Haley, a metals expert who testified on issues of metals in vaccines during congressional hearings:

***“A single vaccine given to a six-pound newborn is the equivalent of giving a 180-pound adult 30 vaccinations on the same day. Include in this the toxic effects of high levels of aluminum and formaldehyde contained in some vaccines, and the synergist toxicity could be increased to unknown levels. Further, it is very well known that infants do not produce significant levels of bile or have adult renal capacity for several months after birth. Biliary transport is the major biochemical route by which mercury is removed from the body, and infants cannot do this very well. They also do not possess the renal (kidney) capacity to remove aluminum. Additionally, mercury is a well-known inhibitor of kidney function.”--Boyd Haley Ph.D.*** [end of quote, emphasis added: Boyd Haley, quoted by LD Wedewer in *Autism and Aluminum Vaccine, Exposure Comparison Study*©, *Autism In Focus*©, December 10<sup>th</sup>, 2002 Newsletter, at:

***<http://autismawakeninginria.bizland.com/autismandaluminumvaccineexposurecomparisonstudy/index.html>, also submitted as official testimony on behalf of the public for December 10<sup>th</sup>, 2002 Government Reform hearings on vaccinations.]***

Particularly troubling for me, in Dr. Boyd Haley’s comments was the phrase: ***“A single vaccine given to a six-pound newborn is the equivalent of giving a 180-pound adult 30 vaccinations on the same day”.*** Yet, vaccines continued to be given, from the first few days of life with no chance given to the liver to mature and begin to produce bile to help with detoxification

**functions!** The liver – the body’s main detoxifying organ, did not produce bile until a child reached six months of age.

From everything I had read, I also knew the blood brain barrier - the envelope that protected the brain - was also not fully formed until at least six months of age. Did that leave the brain more susceptible to viruses from vaccines? I very much suspected it did.

This site, founded by Dr. Haley, provided invaluable information to parents who wanted to learn more on this issue of vaccines – I encouraged all parents to spend some time surfing the information provided here:

<http://www.testfoundation.org/>

Another excellent site providing Dr. Haley’s testimony and many, many other items of interest regarding vaccines was <http://www.whale.to/vaccine/haley.html>. This site also provided a link to the text of Testimony Before the House Government Reform Committee by Boyd Haley, Ph.D. November 14, 2002 as well as a Letter by Boyd Haley, PhD, in response to an article on the ADA web site by the ADA President (May 23, 2001). This was very interesting reading to say the least. I encouraged all parents to read this information quite closely!

According to research done by US Autism Ambassador LD Wedewer, comments attributed to metals expert Boyd Haley also included one stating that **“any good biochemist knew that thimerosal and aluminum reacted dangerously when combined together”**.

Thus both mercury and aluminum, individually, but especially in combination, appeared to be a major problem!

Indeed, attorneys for the vaccine injured, via their “discovery process” had uncovered rather shocking information when it came to this issue of “mercury and aluminum used in combination” in a single product... and that information dated back to 1972 – over 30 years ago – and well before the “autism explosion”.

Note a quote provided on this link: <http://www.testfoundation.org/thimelililly.htm#Waters & Kraus>.

***“1972 - British Medical Journal reports case of skin burns resulting from the chemical interaction of thimerosal and aluminum. "Mercury is known to act as a catalyst and to cause aluminum to oxidize rapidly, with the production of heat."The manufacturers who supply us with thimerosal have been informed." [Thimerosal is being used in vaccines which also contain aluminum].”***

Much more information on this issue of “what did the pharmaceuticals know... and when” was available on the following link on this same link referenced above.

When I put this information together with the neurodegeneration video from the University of Calgary, there was simply no denying that mercury, in and of itself, and indeed, mercury when used with aluminum, played a role in neurodegeneration... and again, as clearly indicated in the Simpsonwood meeting, aluminum, in and of itself, appeared to also very much be a problem! I quote again from the Simpsonwood transcripts:

**Dr. Weil, pg. 24:** "One, up until this last discussion we have been talking about chronic exposure. I think it's clear to me anyway that we are talking about a problem that is probably more related to bolus acute exposures, and we also need to know that the migration problems and some of the other developmental problems in the central nervous system go on for quite a period after birth. But from all of the other studies of toxic substances, the earlier you work with the central nervous system, the more likely you are to run into a sensitive period for one of these effects, so that *moving from one month or one day of birth to six months of birth changes enormously the potential for toxicity. There are just a host of neurodevelopmental data that would suggest that we've got a serious problem. The earlier we go, the more serious the problem.*"

*"The second point I could make is that in relationship to aluminum, being a nephrologist for a long time, the potential for aluminum and central nervous system toxicity was established by dialysis data. To think there isn't some possible problem here is unreal."*

**Dr. Egan, pg. 77:** *"Could you do this calculation for aluminum?"*

**Dr. Verstraeten, pg. 77:** *"I did it for aluminum...Actually the results were almost identical to ethylmercury because the amount of aluminum goes along almost exactly with the mercury one."*

**Dr. Caserta, pg. 234:** *"One of the things I learned at the Aluminum Conference in Puerto Rico that was tied into the metal lines in biology and medicine that I never really understood before, is the interactive effect of different metals when they are together in the same organism. It is not the same as when they are alone, and I think it would be foolish for us not to include aluminum as part of our thinking with this."*

And, finally, this comment from the Simpsonwood transcripts – another comment that I also found very interesting....

**Dr. Clarkson, pg. 21:** *"There is an issue that pharmacokinetics might be different, too. Again, this is all animal work, but the animal studies suggested, for example, a suckling animal does not eliminate methylmercury until the end of the suckling period, and there is a mechanism on the study for that. So there could be an age difference in the excretion rates."*

This seemed to indicate to me that not only were mercury, and aluminum major issues, but, if the child was nursing, there very much could also be a possibility that the child could not "excrete" the toxins until after nursing had ceased. *Given mercury could be passed from mother to child via breastmilk, that certainly was again, a huge issue of concern!*

Was this missing ability to eliminate methylmercury in suckling animals tied to the fact that, in humans, bile was also not produced in the first six months of life... the very time an infant could also be suckling? Why was it that during the most critical period of life – when a child was suckling – that bile was not produced? I did not know the answer to that but, now, there were so many issues that concerned me...

I now also believed that viruses - in and of themselves - and iron overload - very much played into this puzzle also. Excess iron was known to accumulate in all major organs. Viruses needed iron to grow and thrive. Iron overload very much appeared to be a problem in children with autism and it was well documented as an issue in many, many disorders – disorders such as Alzheimer’s – a disorder that I now knew to have over one hundred parallels - to autism – a disorder I now very much suspected to be nothing more than “autism in the elderly”.

It appeared iron overload, found in so many of these disorders, provided the perfect environment for viruses to grow and multiply. The thought of prenatal vitamins – loaded with iron – certainly was of major concern to me because I now knew that iron impacted insulin – a hormone – and a very critical one at that – and that this relationship between iron and insulin was bi-directional.

Hormones were extremely sensitive – measured in *parts per trillion*.

Iron, in excess, could lead to tremendous damage in the body. In addition, iron was known to bind to nitric oxide. Nitric oxide production issues had been identified in those with autism, Alzheimer’s and schizophrenia – all disorders I now believed to be but shades of the same thing. Excess nitric oxide was scientifically shown to lead to cell death.

Mercury also impacted hormones. Mercury was also known to “love sulfur”. Sulfur was also found in enzymes, proteins, blood, and antibodies. What we saw in autism appeared to be the result of several factors coming into play... mercury, aluminum, iron, and viruses themselves. These, in my opinion, were the primary culprits behind this disorder. All these issues were discussed at length in my third book and I strongly encouraged all parents of children with autism to read this text as there was simply too much to even begin to get into here. As important as language development was, understanding the many critical issues that played into “autism” was, in my opinion, just as important – if not moreso. How could one possibly begin to address the issues without first understanding them? As such, I could not stress enough the need for all parents to also read “book 3”, Breaking The Code: Putting Pieces In Place! posted in full on my website – as were all my books – at <http://www.autismhelpforyou.com>.

In my first book, I had come to understand that “order” or “categorization” was absolutely key in Zachary’s issues. In so much, he seemed to always want things in a specific way. By the time I had completed my second book, I realized that the reason “order” was so critical to Zachary was because in everything, it appeared he needed to “break the code” in order to understand “how things fit together”. I came to see that, in Zachary’s case, it was as if **he could not understand a concept without first understanding each individual part to that concept.**

For example, in order to understand “a pencil”, Zachary had to first understand all the “components” that made up a pencil... the wood, the color, the eraser, the lead, etc. I found in so many things, before Zachary could understand “the concept”, I had to label everything for him in order to help him understand how they all “fit together”. Without that “integration” of the “parts into the whole”, Zachary’s world was but a world of incomprehensible bits and pieces, and, indeed – a world full of frustration. This was true in so, so many areas of life... in everything from language to emotions, to behavior.

One of the functions in the parietal lobe involved allowing one to **integrate sensory information for the understanding of a single concept** – and this, clearly was an issue for Zachary. That could result from two things. First, either this particular part of the brain was not working or second, the sensory information (visual, auditory, touch, etc.) was not properly reaching this part of the brain. The various senses were located in different parts of the brain, and as such, I strongly suspected, given the University of Calgary study, that the issue was more one of sensory input not making it to the right place in order to be properly integrated into the understanding of a single concept. The fact that so often, seizures were documented in these disorders also seemed to be very much in line with this theory. Seizures certainly appeared to result from improper neural connectivity or transmission - almost a “short circuiting” of the brain.

Seizures could take many forms... blank stares, aimless wandering, and aimless or repetitive motor functions (i.e., picking at things), etc. Although children with autism were known to develop seizures at puberty, I suspected that seizures could very much be what we were seeing with “blank stares” also – something so very common, so very early on, in children with autism! Certainly, there could be no doubt that blank stares in children with autism could be nothing more than seizure activity that was not recognized for what it truly was by parents who were so new to the world of “autism”. Again, given the University of Calgary experiment showing neural degeneration due to mercury exposure appeared to be a confirmation of this very, very strong possibility.

By the time I had completed my third book, I had the opportunity to study brain structure and function a great deal more and now, more than ever, my suspicions of little or no communication among the various parts of the brain seemed to be confirmed. As I looked at the chart showing what specific parts of the brain were responsible for, there simply could be no denying the case for little or no communication among the various parts of the brain in the children of “autism”.

Did that mean connections had been severed permanently? In my opinion, the answer to that was a resounding – no! The brain was believed to reach 95% of its adult size by the age of 6. Yet, we were constantly making new discoveries relating to the fascinating human brain and its ability to adapt to trauma. And, we also knew that the more a specific part of the brain was used, the more it developed or formed “new connections”.

In my opinion, the key to that “adaptation after trauma” was in understanding how to bridge the various parts of the brain by using similar functions that existed in different areas. For example, there were memory functions in various parts of the brain. This was also true for visual and language functions. As such in order to “reconnect” the “disconnected”, the key had to be in

activating those areas that were “similar” and that could possibly stimulate various parts of the brain at once.

I truly believed that in stimulating only limited parts of the brain – something I saw in so many current therapy practices - that we were not addressing the underlying issue. To “reconnect” the brain required activating as much of the brain as possible – at once! This was the reason for which I now firmly believed that a computer was a medical necessity for these children. While on the computer, almost the entire brain could be activated. That certainly appeared to explain why so many children, like Zachary, absolutely loved the computer. While on the computer, it was my belief that as a result of the tremendous brain activity going on, these children could much more easily come to “break the code” and finally understand their world as the various parts of their brain – together - worked on “breaking the code” – all at once! Clearly, having several functions working at understanding something had to be better than having just one or two functions attempting to solve the problem.

Finally, it was also my belief that because of the very limited communication that existed among the various parts of the brain in children with autism that **functions co-located in one area appeared to attempt to compensate by becoming much more integrated.** In other words, it truly appeared that even though functions across, for example, the frontal, and temporal lobe, were not communicating the way they needed to be, that **functions within a specific area** – for example, within the temporal lobe itself – **appeared to have a magnified or increased ability to interact with one another.**

Again, there could be different reasons for this. It stood to reason that those neurons closest to one another would interact the most with one another. As such, neurons in the temporal lobe more than likely had better communication – due simply to physical location – with one another than say would neurons in the temporal lobe interacting with those in the occipital lobe. That had huge implication for teaching and/or communication. For example, the frontal lobe, associated with production of language, motor functions, sense of self, imagination, etc., appeared to have no visual functions associated with it. As such, to use visual input to teach a child with autism was in my opinion, not the best approach, and perhaps, this helped to explain why up to 50% of these children were – non-verbal!

In addition to “physical proximity” of neurons in matters relating to how well specific parts of the brain communicated, was the issue of neurofibrillary tangles. The University of Calgary experiment had stated that after mercury exposure, not only were neurons completely devastated and impacted in terms of their future growth potential, but, neurons also went on to form neurofibrillary tangles. What that told me was that the potential was certainly there for neurons having normally different functions to become “entangled” and hence start communicating more with one another. That certainly could explain why we saw this apparent increased communication in so many functions relating to autism – for example, the uncanny ability to remember so many facts, figures, texts/videos, etc.

It had been well documented that many children with autism appeared to have a fantastic memory for certain facts. Memory and “categorization” functions were co-located in the temporal lobe and as such, I certainly could understand why this would be the case given my

theory of heightened communication among the various functions located within a specific region of the brain. All of this had absolutely huge implications in terms of not only reaching the child with autism, but also in understanding, teaching and controlling the behavior of the child with autism.

Thus herein were the most valuable keys of all in finally coming to understand and reach the children of autism! The three critical keys, I firmly believed were: 1) to activate as much of the brain as possible in attempting to “break the code” to anything 2) to make use of similar or “bridging” functions that existed in various parts of the brain, and 3) to understand the positives and negatives implications of heightened communication among the various functions co-located within a specific part of the brain.

There was no doubt that this last point was also very, very critical. Within this heightened communication among the various functions of the brain within a specific individual region (i.e., the temporal lobe *itself*, or within the frontal lobe itself, etc.) were in my opinion, keys to helping these children but also the traps that could only further make them worse!

For example, within the frontal lobe, there resided both the functions of imagination and the concept of self. Were these functions to become “too integrated”, obviously, that could result in disastrous consequences – the loss of self and the loss of one’s sense of reality. Note that although the concept of self and the function of imagination were co-located in the frontal lobe, the ability to distinguish between truth and a lie (the real and the non-real) was located not in the frontal lobe, but in the temporal lobe. As such, if one had heightened communication among functions relating to the concept of self and imagination but had little or no communication with the functions located in the temporal lobe – that part of the brain that appeared to play a role in one’s ability to perceive reality - then, the implications of that were serious indeed, because, quite clearly one could very much lose touch with reality if these parts of the brain were not communicating properly and there existed heightened communication or interaction among functions relating to the sense of self and imagination.

Thus again, the keys were in understanding the various brain structures and functions and in using those things to one’s advantage in reaching these children but in very much keeping a close eye on “the traps” that could be very, very detrimental if not kept “in check”. I discuss these issues in much greater length in both my second and third books and as such, again, I strongly encouraged all families afflicted by autism, Alzheimer’s or schizophrenia to read these books I had previously written. I could only briefly touch on these issues here to provide just “a glimpse” of the issues as I saw them – issues that had been the focus of my previous works. In my opinion, the implications of all this were absolutely huge - those implications could be hugely beneficial, or hugely detrimental!

Having covered issues of “common ground” as they related to vaccines, etc., I would turn my attention, specifically, to matters of communication, tie these issues related to communication to matters of brain structure and function and how provide insights as to what I believed parents could do to help their children either gain or increase communication skills. Again, I was certainly no doctor or therapist. These were simply insights I had wanted to provide – as a mother - based on what I had seen in my son in terms of language development.

Although we usually thought of “communication” as “talking to one another” the implications of all this spanned far beyond that... to communication issues in terms of understanding behaviors, in terms of understanding best teaching practices for these children, etc. Truly these materials impacted absolutely all areas of life for these persons. As such, the materials in this text were of value to all families facing autism, Alzheimer’s and schizophrenia – including those families where children were already verbal.

In order to provide a “common ground” in terms of “language development” for all readers, however, I also needed to provide the following section on language issues as written in my second book, *Breaking The Code To Remove The Shackles Of Autism: When The Parts Are Not Understood And The Whole Is Lost!*

This section provided many, many of my thoughts on language. “Updates” to this information and a discussion of “what had worked” or “not worked” based on brain structure and function as well as information on “what else to try”, and “what to watch out for or avoid”. In my opinion, there could be no denying that children with autism had to be taught in a very, very specific way. That was what I hoped to show with the remainder of this of this book as I provided my insights not only on “what had worked for us” but on “what I would have done differently” had I known then, what I knew now.

Again, those persons who had already read this text could simply skip ahead to the next section entitled “Updates To Language Section Provided In Book 2” although in my opinion, reading this again would certainly provide a good “refresher”.



## **Start of Section From “Breaking The Code To Remove The Shackles Of Autism: When The Parts Are Not Understood And The Whole Is Lost”!**

Note: This was basically a complete reproduction of this section... a section with many smaller “sub sections”. See Table Of Contents for “Start/End” page numbers for this section if you have already read these materials previously

My comments/updates would follow.

Teaching Language In Autistic Children...

Based On "Building Blocks" With Specific Order

As I watched an alphabet video with Zachary on 1/20/02, and I saw each letter flash across the screen, I thought to myself, hum... "Zachary knows his letters and indeed can read a bunch of words, yet, he is still absolutely fascinated by the alphabet and counting videos". I thought to myself that surely over time, these alphabet and counting videos would lose their appeal, but, they had not ... not after two years of watching them. As I watched Zachary, he still enjoyed these videos so much. What made the alphabet and counting so intriguing? It took me a very long time to figure it out. After a few months, the answer finally came... PARTIALITY! The alphabet and counting provided building blocks on which so much of "the whole" in life were formed. They were the "lowest" levels of language and mathematics... the lowest common denominators to so much more in life.

The more I pondered this puzzle of language and the autistic child, the more all the pieces fell into place. From this point on, I will be discussing "language" specifically, although this concept was equally applicable to teaching mathematics, or any other subject... the concept was always the same... teaching things based on a "building blocks approach" from the very lowest level up.

As I continued to ponder the question of language acquisition in the autistic child, I started to really observe everything as it related to language. I knew Zachary's problem somehow had to do with "order"... so, I thought of the alphabet as it related to order and specifically, to the "parts of a whole". Now things began to make sense when it came to the acquisition of language in the autistic child.

Just what exactly "was" the "acquisition of language" or of "communication skills"... it was the "breaking of a code". And that was the key to it all... the alphabet was at the core of communication... autistic children saw this code everywhere... and until they could "break the code", their world would continue to be one marked by great frustration.

## Breaking The Code!

Perhaps the best way for parents to think of everything presented in my materials as it related to the need to understand "the parts" before "the whole" could be understood, was to think of all these issues in terms of the autistic child's need to "break the code".

By this, I meant that in order to understand almost everything in his world, the autistic child first had to understand how every aspect of every part fit into the "whole". This was true in everything from language to emotions, socialization to process completion, sensory (visual, auditory, touch, etc.) input processing to issues with potty training. All these things - be they behavioral, social, emotional, or sensory - first had to be broken into their respective "parts" for the whole to be understood.

Thus, for the autistic child life consisted entirely of "breaking the code" or breaking things down to their lowest level. Once each part was understood, the whole could then be "put back together" and understood for what it was. Until that happened, everything in the autistic child's mind would be perceived as:

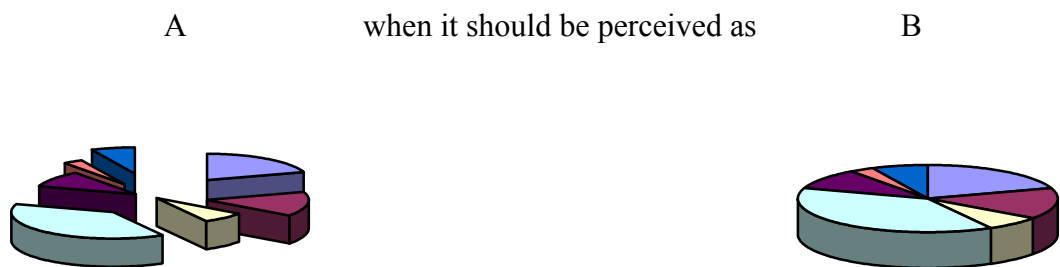

The key, therefore was in helping the autistic child "break the code" to get from A to B... and again, this is true in absolutely all areas of life for the autistic child! :o)

There were many things that the "attempt to break the code" could explain in terms of language. Perhaps one of the most concrete and simple to understand, however, was that of the autistic child's fascination with captions/credits at the end of a movie.

## Fascination With Captions... And "Breaking The Code"...

The autistic child's absolute fascination with movie captions/credits could easily be explained by [my theory](#) that the autistic child needed to first understand the "parts" before he could comprehend "the whole".

Letters were the first building block to understanding language. Time and time again, however, parents had stated that their children could communicate but still did not understand the concept of language, specifically, of the alphabet. Communication, they said could, occur through the use of PEC (Picture Exchange Communication) or other means, even without understanding the alphabet. Well, that was certainly true. However, not understanding the "concept of letters" yet, did not mean that the child was still not constantly striving to "break the code".

So, if you think about captions, several issues could now be addressed. The best way for me to explain this was via the use of the example of "military decoding". The military was constantly trying to "break the code" of various organizations. I believed that this was also what the autistic child was doing... trying to "break the code". I then wondered, well, if this was true, why would the fascination with captions at the end of a movie still be there for children who did understand the alphabet... who had broken the code, and understood the basics to the concept of language.

It took me very little time to come up with the answer. Did the military decoder stop reading coded messages once the code had been broken? No, if anything, he reads them with more passion... now understanding the basics and continuing to look for "the big picture" in order to piece more and more together... much in the way autistic children continued to look to decode things in their memorization of often worthless facts. I once knew a child who could tell you the make, model and year for every car ever owned by everyone he knew. Other children could tell you "all the facts" related to baseball players, etc.

Much like the military decoder, so, too, did I believe was the autistic child looking to "further decode" as he captivated himself with captions... trying to understand "more and more of the code" to help make sense of his world. The autistic child knew there was "some kind of message" in all those captions... and they scrolled by so quickly that when he attempted to "decode" captions, his entire focus was on that task, explaining his very much fixated look and the often physical motion of moving up as close as possible to the television screen.

If this thing called "the alphabet" was a code that helped explain so much in his life, of course, he would grasp every opportunity to further "break the code"... and to autistic children who were so often so very intelligent, captions provided an interesting and challenging code to be broken. I, therefore, think that, as boring as it was, parents should take the time to "pause" the VCR and explain these "caption codes" to their children... especially if their child had already mastered the concept of the alphabet. By explaining that these were the names of "people in the movie" or "people who made the movie", you could perhaps prevent captions from becoming an overtaking source of fascination. In my view, it was absolutely critical to make them understand that this was, for the most part, truly "worthless" information as far as they were concerned and that the **only** purpose of captions was to let you know who had been involved in making a film. I

encouraged all parents to take the time to provide this explanation for their children, and to do so as often as necessary in order to prevent “captions” from becoming “all consuming” in the life of the child. Understanding the “idea” behind captions was all the autistic child really needed to know. **Parents had to do everything they could to help the child break the code as well as identify for the child those things that were meaningless in breaking the code to life! :o)**

Given all this, what happens when the autistic child was unable to "break the code" - specifically, as it related to language. The answer was quite simple. Either the child remained **silent** or, in his constant attempts to "break the code" attempted to understand communication and in doing so, engaged in and "**ordering language**" - something that had, in the past, been referred to as "nonsense language".

## "Ordering or Reference Language" (Once Called: "Nonsense Language")

What some used to refer to as "nonsense language", I chose to refer to as "ordering language" and I encouraged all parents to refer to this behavior as "ordering language" from now on... because that's what it was. It made perfect sense once you saw it from the child's perspective... it was not "nonsense" ... and in fact, when examined in terms of the inability of the autistic child to understand the whole without first understanding the parts, it made perfect sense and was truly a testimony as to the resourcefulness and absolute determination that could be found within these children!

In my opinion, echolalia and ordering language were simply variations of the same coping mechanism used by the autistic child to deal with stressful situations as they pertained specifically to "breaking the code"- to understanding language. The child was simply trying to "order" his world, to "order" what he had heard.

**When I had first started phonics with Zachary, he engaged in “echolalia” in that, again, he repeated for himself every letter. It was becoming more and more evident to me that there clearly was a difference between “incoming sounds” and sounds he actually produced himself and as such, his best learning occurred when he himself made the sound!** This certainly explained issues with echolalia and ordering language. Language was “better understood” if Zachary uttered it himself!

Echolalia, the parroting of everything one heard, had long been associated with autistic children. It was my opinion, that echolalia was simply an "immediate", "on the spot attempt" at "breaking the code" of language. By constantly repeating what was said, the child was trying to also "figure it out" as well as, I believed, commit the "utterances to memory" for future reference purposes. It was a more "immediate" verbal coping mechanism in the sense that the child was trying to cope with what was happening at that particular moment... what he was hearing "right now".

Ordering language, on the other hand, was a coping mechanism used to help "sort" those things heard in the past or still in the process of being "decoded"- but perhaps not pertaining to the current situation at hand. I saw this as a "less immediate" coping mechanism. It was one the child used as he went about - thinking - and trying to break that code that had yet to be understood. It was important to note that "ordering language" could be related to something the child "heard" during the day, or something "he saw" for example. Ordering language was simply a verbal utterance of "what" the child was trying to decode at the specific time the "ordering language" was heard. Hence, parents should take these utterances as "cues" of things to work on at that specific time to help their children "break the code". There was no doubt in my mind that autistic children somehow processed things "differently" and as such, ordering language could be quite frustrating for the parent who had a very difficult time making it out - at least at first. But, with practice, it did get easier.

Another example of this "ordering language" that truly helped me understand it, was something that happened one day when Zachary was working on the computer next to me. I usually said: "sit down" when I told him to sit in his chair to start working on his computer. On this day, he

was already sitting, but, he was very slouched, almost to the point of falling off the chair. So, of course, I said: "sit up, please". When I said that, he replied: "stand down, thank you".

He was making "opposite associations" in trying to understand his world. If the word "up" went with sit, then, obviously, to him, the word "down" had to go with the word "stand" and likewise, the word "please" had to go with "thank you". Obviously, to counter such reasoning, I must admit was rather difficult for me at first. I simply decided to "show Zachary" the act of "sitting up" and to then show him that you could not "stand down". Instead, I showed him "lay down", "stand up", etc.

Zachary had been trying to "combine words" to figure out how they fit together in order to provide for himself a "reference" he could draw on in the future. These attempts at figuring out how words fit together and how they could be used in the future, I came to call "**reference communication**" since Zachary created for himself "references" of how words could be used for future use!

Siblings could be a great help in figuring out the "ordering language" and what the child was saying. On many occasions, I found my daughter Anika, age 10, to be much better able to understand her brother than I was. She understood his utterances as they related to videos or computer programs... when Zachary said something and I just did not understand, often, Anika would say: "mom, he's talking about.... in this computer program". She was more familiar than I was with many aspects of his activities. She had watched the same children's videos, and worked on the same computer programs, and so, often, her insight as to what he was saying was simply invaluable. :o)

Ordering language was a coping mechanism used by autistic children in attempts to "break the code", but, I had come to understand that "ordering language", indeed, had a dual role as a coping mechanism. The first role of ordering language was just that - it helped the child "order" his world - it helps him understand it! The second role of ordering language, however, was that it also helped the child to cope when things "fall apart", when life simply was too stressful and the child needed to "bring things back" to a level he could understand. In this sense "ordering language" was used as an "order fix" by the autistic child when the world all about was too stressful to handle.

For example, when stressed out, Zachary reverted back to words like: "green truck", "a fan, a fan, a fan", or "circle, square, triangle"... these were all things that I could now identify as "coping words" from Zachary's perspective. A green truck was a concrete object he could visualize... with its spinning wheels and colors. A fan, too, was something else he could visualize - spinning - making the partial whole as the blades of the fan disappeared as it turned. Circles, squares, and triangles were specific shapes... they never changed, they were constants and so they provided "order"... or "an order fix" as I called it... a way for the autistic child to reduce his own stress levels by reverting back to "an ordered world" or to those "parts" of the world he understood and by doing so, by "reverting back" to something he understood, the child reduced his own stress levels and was allowed to remain "in control" of the situation. Thus, ordering language also provided a coping mechanism as it allowed the child "to be more in

control" of his world. A few concrete examples will better help readers understand this and to also understand why I came to the conclusions I did on this issue.

When Zachary used to be very frustrated at first, before I figured so much of this out, he often made use of one small phrase throughout the day... for what seemed to be no reason at all, out of nowhere, he would say: "green truck".

What was he doing or thinking when he said: "green truck"... out of nowhere? I had often wondered about that. I had now come to see that there were several things going on. Zachary had always been fascinated by wheels... no doubt because of the spinning effect they provided (see section on [Spinning](#)). While on the highway, if Zachary ever got upset, all I had to do was position myself next to a large truck and let Zachary look at the wheels for a while... they provided an "ordering fix" for him. Obviously, I could only do this where there were two lanes going in the same direction. Luckily, in the suburbs of Chicago, there were plenty of those "multiple lanes" - of course, those drivers behind me did not always appreciate my doing this. :o) A truck soon became a favorite coping mechanism... as did colors. I was recently told by an adult autistic that - as a child - he perceived objects as colors. This was all very fascinating to me. For more on that, see my section on [The Role of Colors In The Life Of The Autistic Child: The Pot of Gold At The End Of The Rainbow©](#).

If the autistic child indeed perceived objects as colors, the use of the phrase "green truck" as a coping mechanism now all made perfect sense. These two words provided for Zachary two very strong coping mechanisms all rolled into one phrase. The color, in my view so important to the autistic child and his understanding of the world, and the spinning... the making of the partial whole... provided by the image of a truck - these two things, when combined, indeed provided a powerful coping mechanism... an actual image the child could put into his mind to help him cope with the frustrations of life - on demand!

When spinning or other coping mechanisms were not available, Zachary simply resorted to saying: "green truck"... providing for himself yet another perfect "order fix" - a simple way to "de-stress" when life just became to unbearable or stressful!

An example of how ordering language was used as a coping mechanism, a means of "ordering the world" occurred on the day Zachary tried to figure out "Walk" and "Don't Walk" signs.

Zachary and I had gone to the store to buy something one day. As we crossed the street, I made it a point to show Zachary the "Walk" and "Don't Walk" signs. He repeated: "Don't Walk" since that was flashing at the time. At the end of the day, before he went to bed, Zachary started saying: "Walk... Don't Walk"... and repeating that over and over again. He was "ordering" what he had learned during the day... and in this instance, understanding this concept could literally save his life. It was at that time that I truly understood the importance of ordering language.

I often worked on spelling with Zachary... a subject he loved. I often asked him what word he wanted to spell. Even though he was just under 4 and 1/2, "big words" did not scare him. One day, he asked me to spell one of his favorites, "wheelbarrow" (around that time we gave him

many wheelbarrow rides :o) )... so, I wrote this word , on one of our many chalk boards. I then spelled it out with him. This day was really no different than most as we worked on various things throughout the day like potty training, spelling, playing on the computer, etc. As with so many other days, it was soon time for Zachary to go to bed.

I had often taken Zachary to bed with me - what so often started as a desire to simply calm him down for the night usually ended with his staying with me all night. Too often, it was I who fell asleep first. :o) On this particular morning, I noticed something - when Zachary awoke, the "nonsense language", which I have since then come to understand as "ordering language", started right away.

The following morning, the very first thing he said when he awoke, was.... "wheelbarrow... w...wheelbarrow". Again, this clearly showed that his "waking state" was certainly focused on "ordering" what he had learned recently. I had, in the past, seen him do the same thing with "walk vs. don't walk", with the "entire alphabet... a is for apple, b is for bed, etc., all the way to z... and do that twice, using different words for almost each and every letter before he could settle down for the night - at that particular time, when Zachary would "go through the alphabet saying words for each letter", we had just started to work on phonics.

An excellent spelling program that involved auditory learning was that provided by the following company: <http://www.writing-edu.com/spelling/>. For \$99.00 parents could get 5 spelling CDs for levels A, B, or C. The package included: 5 AUDIO Compact Discs, 1 set Flashcards, 1 set small "zoo" cards, and Intro Video and Teacher booklet. This was a fantastic way to teach spelling basics! :o)

Update: My sister-in-law initially thought this would be an excellent program for her son. However, upon using it, she felt it had not worked well for Andrew. She now considered him more of a visual learner than an auditory learner. I very much considered Zachary more of an auditory learner. I came to realize, however, that perhaps we were just seeing something "in a different way" when it came to "learning styles" in our children.  
More on this very critical issue later.

I had commented in the first book I wrote, [Saving Zachary: The Death And Rebirth Of A Family Coping With Autism](#), that, once, I observed Zachary almost in "neural overdrive" as he laid on his bed one night, trying to settle down. In this first book, I commented on how it appeared to me as though "**Zachary was trying to order his world" before going to bed...**a function, at the time, I believed occurred primarily at night... as we slept... that as we slept, our brain somehow "ordered" or made sense of everything we had learned or processed during the day.

Then, another thought/observation came to mind. The incidence of "ordering language", at least for Zachary, was noticeably higher at specific times of the day - first thing in the morning, just before bed, and during stressful, non-orderly activities throughout the day. At the time, **I definitely believed that Zachary's problem could lie in the fact that his brain may not be functioning as it should to "order things while he slept" and thus, he had an intense drive to consciously perform the "ordering" function while he was actually awake!**



Now that I understood the need to "break the code" in the autistic child, I saw the need to "order" things in waking and sleep cycles. If the need to "order" the world was so all-consuming during waking hours, could this also explain difficulty in sleeping in the autistic child? Could it be that the brain truly was in "overdrive" even while Zachary slept? If this were true, then, it made my belief that for the autistic child - "[Rest Is Work Too](#)©"- even more true - because **perhaps for the autistic child, there was much more going on during sleep (and waking hours) than should be normally occurring when it came to "understanding the world", and the "ordering" of what had been learned and/or processed during the day!** I could not help but wonder. **Was his brain in overdrive at night... processing more than it should in terms of "ordering his world" or was this function of "ordering not even occurring at night" and as such Zachary, himself, had to perform it consciously during the day? ... or, was it the opposite... that the need to understand the parts before the whole could be understood necessitated that the ordering function be the primary function during BOTH day and night?** I had no way of knowing. All I did know was that Zachary had an almost innate defense mechanism that forced him to perform the "ordering function" during the day, while he was fully conscious or awake. His entire life seemed to revolve around his need to "break the code" - in everything!

**Given what I have come to understand about ordering language, I strongly believed that it should be allowed.** In the past, I had thought this behavior needed to be "broken" or made "extinct". At that time, however, I simply did not understand ordering language for what it truly was... I still saw it as "nonsense" language... I still saw it as simply "an order fix", much like a "drug fix"... I did not see it as an "order fix" in the sense of it being an actual coping mechanism to make sense of one's world.

As such, I would, personally, **never** discourage the use of ordering language in an autistic child, but rather, I would encourage all parents to use look at ordering language as a cue of something "to work on", of something "to decode" or explain. Upon hearing any ordering language now, I immediately looked for the opportunity to show Zachary how "what he was trying to order or decode" - that part - fit into the whole. :o)

As the Zachary learned more and more via labels and explanations each day, I found "ordering language" now almost nonexistent. It showed up a little at night before bed, and maybe a couple of times during the day... that was it. The utterances were so few and far apart that most people would probably never even notice them now. :o)

**Given the importance of this coping mechanism in the autistic child, I, personally, would not try to stop or prevent it in any way!** In my opinion, as the autistic child learned to cope and to understand his environment more and more, this ordering language should greatly diminish, and eventually, will most likely disappear altogether. :o) But again, the key to reducing and/or eliminating ordering language in my opinion, was simply in helping the autistic child see how all the parts fit together to form a whole... in everything. As with everything else, when these coping mechanisms "come out"... I encouraged parents to look for the source of the child's frustration and to help the child deal with that frustration through the use of labels, explanations, fractions, coping mechanisms like counting, etc... those things that provided productive coping mechanisms in that they helped the child to [break the code!](#) :o)

I would ask all parents to begin talking in terms of "ordering language". Personally, now that I truly understand "ordering language", the term "nonsense language" is offensive to me. The fact that this was not understood in the past, from our perspective, resulted in a label of "nonsense language" being tagged to children who, in reality, made perfect sense. The fact that parents, researchers, doctors, etc., did not understand this for what it was resulted in our associating very negative labels with these children - making them to be seen as having "broken minds", when in reality, it was simply a matter of our lack of understanding. But, as with everything in autism or any other illness associated with "mental dysfunction" - it's all in the label - and quite frankly, I was tired of our children being seen as "broken persons who made no sense at all" - because everything did make sense - when you saw it from their perspective - in spite of the fact that a very critical function within them, the ability to integrate sensory information, was truly "broken"!

Before we continue with other topics as they relate to language in the autistic child, I wanted to provide for readers "what I used to believe" as it related to "nonsense language". The reason I provided this was because there was a critical lesson here to be learned by all parents and professionals.

Luckily for our family, I quickly realized the importance of "ordering language" and it was because of this "realization" - that "this particular type of language was so **critical** to the autistic" child - that I wanted to provide an example of what could happen when a negative label was given ... simply because we failed to understand the autistic mind and chose instead to show it as a "broken mind" by associating it with a term called "nonsense language".

The implication of "a broken mind, as reflected in the use of the term 'nonsense language'", to adults, almost by definition made it so that we "wanted to fix it" - especially if we were the parents of that "broken mind". That fix, could take on many forms... behavior modification or other "manipulation" methods that were based on reward - and, often, punishment - systems, the exposure of the child to countless tests, scans, etc., and perhaps most dangerous of all, that fix could take the form of medications... medications given to a mind that was not understood - and if the mind was not understood, how could medication "fix it" in the first place? Did not the fact that the autistic mind was not understood, in and of itself pose a dilemma in terms of the "effectiveness of that fix"? How could one fix with drugs something that was not understood in the first place?

I knew tests, scans and medications were "out" for us as a family. For better or worse, we had made a decision early on not to go that route. I would thus try my hand at a little behavior modification. I had studied psychology through graduate school and felt I knew enough to give this a shot on my own. I knew this was not the case for all parents, however, and as such, I wanted to caution all parents to read and inform themselves and consult with any professionals they could before undertaking any behavior modification program for their child. I understood enough of what was involved to tackle this. There could be many negative results to behavior modification techniques... indeed there were many techniques out there - most of which, I personally, did not agree with. I chose to stay away from anything that involved punishment in any form. Patience and understanding - those were the keys I would use in my "behavior therapy".

I used no negative stimuli, no negative reinforcements, there were no discrete trials, no use of fear or threats, no goal of a conditioned response, no practice schedules, no reinforcement schedules, no "steps" to work through via reward systems... my "behavior modification" consisted simply of seeing "what Zachary would do if all of a sudden, his nonsense language no longer made sense". All I was looking for in Zachary was to see "how he would react" to what I did... nothing was required of him other than listening to what I said.

My goal was simply to get rid of "nonsense language" .. to see if I could somehow make it go away. I knew that there was a reason for Zachary to use specific "utterances" we knew as "nonsense language", but I did not fully understand why particular words were used, together, out of nowhere and seemingly making no sense. It was difficult to explain, but, what I was trying to do was to get to whether or not this truly was "nonsense language"... if it was, then, any "nonsense language" should produce some kind of response... I hoped I would see "my nonsense language" be used by Zachary too. But, if it was not "nonsense language" and there was more to it than I understood, then, my "nonsense language" should not be "used" by Zachary at all. Would Zachary see what I did as just more "silly things mom does" (see Exercises I Do At Home for more on that :o) ) or would **my** "nonsense language" make sense to Zachary and would it actually be language he too would want to use and repeat? That was what I wanted to determine!

Well, if "nonsense language" actually "made sense", I thought to myself, I now needed to do something that would make "nonsense language" - not make sense!

So, how do you go about doing that? I found the trick to it... but, it was a very difficult thing to do... requiring a lot of "on the spot creativity"... and at first, that was quite difficult for me. After doing it a few times though, it became a lot easier. What followed was an example of how I tried to "break nonsense language" in my son, Zachary. At the time, Zachary was about 4 1/2 years old.

When Zachary exhibited his "need for an order fix" as I had called it in my first book, as it related to "nonsense language", I went into action as soon as he had completed his first "nonsense phrase".

It was critical that all readers understand that at this time, I still saw the "need for an order fix" much as a "drug fix" ... not as a coping mechanism! This was a critical difference in terms of how I now refer to "ordering language" as an "order fix". Back then, when I did these exercises, I thought the "fix" from "ordering things" was almost like a "drug high" for these children... that it somehow triggered something in their brain that they just "could not get enough of". I knew that may sound crazy, but, that was what I thought at the time... and that was the "frame of reference" I worked with as I did these things with Zachary. Let's face it, there have been many "silly theories" out there as they relate to autism... like the one adopted by so many "experts"... the old "cold mother" theory. :o) That was how we moved forward in our understanding of everything... you proposed a theory, you proved it right or wrong, you kept the proven and then moved forward in search of another theory or explanation to what was still not understood or proven to be true. Of course, unfortunately, as with so much in life, theories were often presented as "fact" and that was always a dangerous trap to fall into!

Luckily for Zachary, in no time at all, I was able to "disprove" my original "order fix equals an almost drug fix sensation" theory and see what the issue really was. It was an "almost drug fix... but not in the physical sense... what these children could not get enough of... I soon came to understand... was that within the "ordering function" for them, lay the key to "breaking the code" to so much. :o) That was where the "fix" came from... the "ordering function" provided for Zachary a "fix" to understanding his world. It turned out that the "ordering function" provided a "fix" but it was a different type of "fix" than what I had originally thought... but, "a critical fix" nonetheless. :o)

When Zachary exhibited his "need for an order fix" - which, at the time, I thought produced a pleasing sensation much like a "drug fix" would produce for a drug addict -, via "nonsense" language, I now took his very utterances – at that moment – and “used them against him” if you may call it that. For example, if Zachary was using “green truck”, one of his favorites, I started saying something like: “yes... did you ever see a green truck going down the road with yellow dots, purple stripes, orange feathers, with a squirrel on top and a dog driving?”

I made it so “unusual” that Zachary actually had to really focus to “picture it”... he just stayed silent for a few moments, trying to “picture” what I had just said. I could "tell" that was what he was doing... trying to "picture it" in his mind. Then, after a little while, he would give me another word. If it was “a fan” or something else that “spun”, I made sure “my nonsense sentence” did not include anything at all that could reinforce the “order fix” he was trying to give himself.

So, I would never use words like: “did you ever see a fan turning...” because the use of the word “turning” could in and of itself provide “the fix” as he visualized what I was saying. So, instead, I said something like, “yes... I have a broken fan...it’s upside down on the floor and there is a bee on it that has a green hat and a brown shoe”.

The idea was also to make sure I did not use “similar phrases” for the same utterances. So, when Zachary used “green truck” or “a fan” again, I had to come up with something else...it could not be something I had already said in the past... it had to be "totally new nonsense language on my part". To break the nonsense language, I wanted it to be “something totally new each and every time” he used specific words to get an order fix. Let me tell you... that was hard work... for both Zachary and me!

There were times when I saw Zachary’s need for “order” also involve an actual, physical need to “withdraw” in his own space. For example, Zachary had the video/story “The Very Hungry Caterpillar” by Eric Carle and so, he understood the concept of a “cocoon”. As he played one day, I noticed he was physically making himself a “cocoon”, wrapping himself in a blanket as he literally said “cocoon”. I played along and said, “yes, you’re in a cocoon”. Zachary was pretending to be a butterfly. He then came out and flapped his wings like a butterfly...it was great to see him pretend like this.... I knew pretend play had always been an area of difficulty for autistic children. [Today, I have huge reservations when it comes to pretend play. I encouraged all readers to read my section on "[The Dangers of Pretend Play](#)". ]

Later, I noticed, that Zachary used the word “cocoon” as an “order fix” too... almost as if he “sensed” the comfort of an enclosed cocoon. So, when he used “cocoon” that way, I started breaking the nonsense language again... saying, “yes, there is a caterpillar in my cocoon, and it is green with black squiggles, and it wants to come out and eat an apple”. I saw Zachary actually trying to “picturing the caterpillar” I had just described as I used my fingers to pretend I was the caterpillar coming out to look for an apple. Zachary thought that was absolutely hilarious and he started laughing. I always tried to make any exercise I did with Zachary fun for him too... granted that was not always possible as he got very frustrated because I had really “hit a nerve” with what I was doing... I knew his stress and frustration at times told me I was on the right track...but, I did try very hard to keep things fun and interesting... knowing fully well, that in most cases, what I did would undoubtedly lead to frustration and stress for Zachary. But, again, that was what told me I was on the right track! If I got no response at all from Zachary, then I knew this thing with "order" was not "it" - the answer I was seeking!

In looking back now, and analyzing this in terms of how it related to the autistic child's inability to process the whole without first understanding the parts that made up the whole, I had mixed feelings in terms of having done these exercises with Zachary as they related specifically to language. These concerns were expressed in the section, called "[Defined By A Negative Label... And All That Implies :o\( !](#)".

Before getting into that section, however, I wanted to analyze a little further what happened as I went through the above exercises with Zachary. I must say that in all the times I did this with Zachary, I had never once seen him try to "order" my "nonsense sentences". He made no "nonsense language" as it related to **my** nonsense language. So, I believed he simply saw these as more "silly things mom does", but he did not, obviously, feel the need to "order my nonsense language", my "utterances". That told me that, at least for Zachary, something was "different" about **my** nonsense language... and indeed it was. **My** "nonsense language" actually **was** nonsense... **his** "nonsense language" made sense... because it was "ordering language"!

As such, **my** nonsense language, although funny to Zachary, was something he chose to ignore in relation to **his** "nonsense language"... he knew for a fact that **my** language was simply silly... yet, I, and indeed everyone else, had not been able to recognize that his perfect "ordering language" actually made sense - and that for his world to make sense, this was a **critical** coping mechanism!

**Indeed, in my ignorance, I had tried to destroy perhaps one of the most critical coping mechanisms available to the autistic child... his attempts at "breaking the code" as that code related to communication!**

Not surprisingly, since the autistic child was so dependent on the "breaking of a code" to understand everything in his life, once the code was broken, he would show great strength in those areas that were very ordered and based on a building blocks approach... those things such as math and language, etc.. This was also true in terms of physical activities such as putting puzzle pieces or train parts together ... two areas of intense fascination for the autistic child... two activities that made parts become “a whole” once the parts were “put together”. These activities, in and of themselves, trains and puzzles also provided a coping mechanism for the

autistic child in that they helped to “order” the autistic child's world and to “get rid of the parts”... the sources of frustration.

It should also come as no surprise that the autistic child, by the very fact that he needed to “break the code” to understand his world, would be very weak in areas where there was no apparent code to be broken... areas such as socialization, conversation and to some extent, process completion. The key to these areas, surely, was in “providing some kind of a code” for these activities... a list of “things” that go together, numbered activities, etc., to help the child understand the overall situation. Concrete examples of “things to say” or “things to do” would undoubtedly be necessary to gain strength in these areas. As such, role playing was critical for the autistic child to understand areas such as socialization. Conversation and Process Completion, luckily, could be somewhat broken down into “codes” or “parts” too. Conversation included "parts" in the form of subject information, verb information, object of the verb information, etc. Process completion involved sequencing of tasks, thus, lists or numbered activities could be used to one's advantage in teaching processes.

## ABCs To “Breaking The Code” Of Language

When you look at the alphabet, there were certain constants there... each letter had a specific "look", a specific order in the alphabet itself (i.e., C always came after B but before D), and, one or two specific sounds.

As Zachary sat there and watched his alphabet videos, videos that were now close to 2 years old, I remembered that 2 years ago, Zachary's absolutely favorite software program was Dr. Seuss' ABCs (By A Broderbund Company). We had paid about \$14.00 for this software. Zachary could sit there and either listen to a narration that went through each letter of the alphabet, big and small (the “Read To Me” option) or he could click on the interactive part of the program that also went through all of the alphabet, big and small (the “Let Me Play” option). Each letter had a little “script” that went along with it. For example, on letter “A”, it said: “Big A, little a... what begins with A? ... and then it gave a lot of words that began with “a”... all of these words appeared on the screen, along with a picture of each item/word and so Zachary could read along as well as see “what” that was - thus, the label was associated with a visual object. The “Let Me Play” option allowed Zachary to discover all kinds of fun hidden things that related to the specific letter on the screen. This was a fantastic program for any child. It took about twenty minutes to get through the “Read to Me” and Zachary used to love sitting there and listening to it. Zachary could listen to it three times in a row in one sitting. He also enjoyed the “Let Me Play” option tremendously.

Zachary used to watch (“Read To Me” option on the CD) or play (“Let Me Play” option on the CD) this program over and over and over again... and he absolutely loved it. I would say he watched that video or played the software for a good month or two. It was right around the time Zachary started to play with this software that he was confirmed to be autistic by a pediatrician.

Within a month of Zachary's confirmed diagnosis, I had a dream - a dream of "[a room of colors](#)". So powerful and vivid was this dream that when I awoke in the morning, I told my husband he had to watch Zachary... that I had to paint - and so, I recreated the room of colors I had seen in my dream. It had taken me 3 days of constant painting. A picture of Zachary's Room Of Colors was provided below.



Colors were also key in triggering language/communication in autism. This had indeed been true for Zachary.

When Zachary was diagnosed with autism, he was approximately 2 1/2. At this point in his life, Zachary spoke but a few words... and he did not know the alphabet... so I thought! The very day I completed Zachary's Room of Colors and the paint had dried, Zachary entered the room. I had gone into that room to "admire it" and make sure the paint was dry at 6:00 am. Little did I realize that Zachary had followed me in there.

Upon entering the room he went up to the "alphabet wall", touched the letter "H" and said: "AAAAACCCHHHH". He then went up to the "A" and said: "AAAAAAAAA". I was in absolute shock. I had no idea he even knew his letters... he barely said 5 words and had given absolutely no indication that he knew any letters. Indeed, like so many other children, he had lost almost all speech. At the moment this happened, you could have knocked me over with a feather... that was how absolutely unbelievable this was! Within a few days, Zachary had not only showed me he knew the entire alphabet, he also knew his numbers, his shapes and a few other things as well. Within no time, I could label anything simply by touching it and saying the "label" for that thing. I touched the carpet and said: "carpet", touched the window and said: "window". Anything I now "labeled", Zachary could repeat right away, and he knew it. One "labeling" was all it took ... and Zachary seemed to remember the "labeled object" for good! Those first true signs of Zachary understanding communication, of his understanding the alphabet and all that "labeling" had started in May of 2000.

As I watched the alphabet video on 1/20/02, another thought crossed my mind. I knew for a fact that "order" somehow played a role in many of the issues with autistic children. If autistic children had a problem with order, perhaps they needed to start with the very basics in everything... the "parts" to the "whole"... including the basics behind speech...and that meant the alphabet. I had come to understand the need for a building blocks approach to language in January of 2002. It would not be until several months later, however, that I would see this need to understand the building blocks, the "parts" to understand the "whole" actually applied to



everything in the life of the autistic child. It finally all came together when I truly realized that "partiality" (a subset of order) was really the issue for these children... not "just order". Again, it now all made so much sense!

The fact that a "building blocks" approach was needed for language certainly explained why some children had acquired language while others had not. Some had been taught language by parents who perhaps only stumbled upon the proper "order", while others had failed to do so.

Most children acquired language by having parent first begin to "label" things for them. Labels were critical to all children in acquiring language... in making associations that "things had names"... and "things" were then seen as "parts" to other things.

There was a saying, that "the whole was defined by its parts". For the autistic child, this was indeed a critical observation! Until the child could "define" the parts, he could not determine the whole. Therefore, in as much as a word was made up of "parts" - letters -, it was critical that the autistic child **first** understand the concept of letters to then be able to progress to the next level in speech - labels and phonics - then the next level - actual written words - then the next level, the definition of words (nouns, verbs, adjectives, adverbs, etc.), then, the next level, etc. Whereas for a normal child what came first were labels, then conversation, then the alphabet, words, etc., for the autistic child, that order was somewhat reversed. Before there could be conversation, there first had to be an understanding of "where" the parts to conversation came from. Hence, in the autistic child the proper "order" for language acquisition was that of: the alphabet, phonics, words, words defined as sentence parts, and so on. More on the proper "order" for the autistic child was provided below. Suffice it to say for now, that the alphabet was first in the line of things that needed to be learned - the first domino that allowed all others to fall into place.

Thus, the key to teaching language to the autistic is simply to build from the lowest building block up in the correct order!

Like with many autistics, Zachary's speech had started with first echolalia and then "ordering language". But, I had not recognized these for what they were. In my eyes, Zachary's "real speech" - speech I understood - had begun with the alphabet...and then phonics... not with words or "reference communication" as would be the case for a "normal child". Indeed, Zachary's first form of "reference communication" had been the alphabet... having finally "broken the code" of the alphabet, he now had a "reference point" in terms of these symbols and what they meant. Each reference point had a label, each letter had a name of its own... and that first point of reference provided that first critical cornerstone that had laid the foundations to support all future language!

Zachary had been almost completely silent until I had painted my "room of colors". Only when he saw the "room of colors", did "what he had seen" on the computer and on TV provide the association he needed to start "uttering" letters. Again, I wanted to emphasize to parents that I truly believed color was also key in triggering Zachary's language and as such, I strongly encouraged all parents to review my section on the [importance of color](#) in the life of the autistic child. By painting my "room of colors" I had taken these "letters" on the computer and brought them into his reality by actuality painting the letters on the wall... and painting them in various

colors. The letters became "part of the wall". It was as if, all of a sudden, "he saw them"... and when he did, he started saying them, one after the other. In thinking about the inability to process the parts without first understanding the whole, you would think that the "letters" would not be perceived as "part of the wall"... that, indeed, like the "parts" to so many other things, they would cause a sense of confusion and not be understood. So, what was it that had been so different about these particular letters... why had they all of a sudden been "seen". The answer, I truly believed, was in the fact that each letter was painted in colors. Colors were truly a "pot of gold" at the end of the rainbow in the autistic child's life as they provided for him a coping mechanism... a means by which, I believed, the autistic child somehow generated his "own code" of the world in order to make sense of it.

Once the code of letters and colors was broken... and I did believe in the possibility that it was a 2-part code, involving both letters and colors, communication could then begin... in its many forms... phonics, labels, etc. The first building block, the necessary cornerstone, the cornerstone to support the entire "structure of communication" had been laid! Not only were letters labeled, but they were now understood to be "symbols" representing something else... each letter represented a specific sound that could now be pronounced... the sounds of the alphabet itself (I was not talking about phonics here... just the actual "alphabet sounds"... as you would hear them if you just recited the alphabet). The "letter symbols" had now been "labeled" ... and Zachary was able to easily generalize that concept to "other things"... numbers, shapes, physical objects, etc.

In Zachary's "room of colors", numbers and shapes had also been painted... they were made "part of a whole", part of the wall and, again, they had been painted in colors. An important thing to note here was that Zachary actually knew the letters and I did not even know it. I had wasted a lot of time by thinking/assuming he did not have this knowledge.

If I had to do it all again - if I were a parent whose child had not yet mastered the concept of the alphabet, I would seriously consider doing colorful letter representations from the very start... and if that did not work within a week or so, I would go back to the drawing board and look for what else was missing in the equation. Zachary also had an alphabet train video that provided the concept of parts making up a whole (train cars put together to form a train). This video provided a lot of spinning letters. Undoubtedly, that had somehow helped too. My point here was simply to emphasize to parents not to waste time on things that were not working. We had a tendency to underestimate autistic children because they could often not communicate back to us. As I discovered, however, that did not mean that certain concepts, such as letters, were not already known. And, as such, the key was in "getting the child to utter what he did know". If something was not working... do not wait months to throw it out... to try something else or look for "what's missing" in your tool set!

I was not much for singing in those days... but, I could certainly see how the "alphabet song" (also on this Dr. Seuss CD) could be used to teach the alphabet since autistic children responded very well to music... and a song, in and of itself also helped with issues of the parts making up the whole since by definition, a song had a beginning, a middle and an end... and the alphabet song was not "complete" until it was "all sung"... thus, this child's song showed how parts (i.e., letters) fit together to form a whole (the alphabet). In actuality, I did not know if Zachary

"really" learned the alphabet from the song, the actual going through of the alphabet on this software package, or his alphabet train video... all options were there - I was just thrilled that he finally knew it.

So, for parents having a difficult time with obtaining any speech in their children, I would suggest trying the "alphabet song" first, then showing the child the alphabet on a poster that provided each letter in various colors ... where the child could see all the letters in the correct order at once... a "border" type poster would probably be best.... just one long line with letter after letter (as opposed to a more compact poster where "you run out of room and have to go to the next line).

I had taken the letters and "made them part of a whole" - a physical wall - a new entity, and I had used colors - something I now believed to be so critical for these children. That whole could have been a song... or an alphabet border poster. But, my "whole" was a wall. If you think about it, a "wall" was an easier entity than say, a book, for an autistic child to perceive, if I was correct and their issue was one of an inability to process the partial. To the autistic child, a "book" was made up of "parts"... pages, cover, back, stories in text, pictures, etc.... and to the autistic child, perhaps for him to "perceive" and "understand" the "whole" when it came to the alphabet, he needed to "see it all on one page"... just as on the wall in my room of colors with no "other things" to decode (such as words, pictures, physical parts to a book, etc.). Thus, **how** the alphabet was taught was critical. I did definitely believe colors needed to be involved and that the "whole" needed to provide some continuity (such as a song, a border poster, etc.). Do I know the exact combination yet... no... but, I do believe I understood some critical pieces that needed to be there... and that now, it was really a matter of parents putting these suggestions together to find the optimal method of teaching the alphabet. It may be that a combination of methods were needed... colors, songs, videos, etc. But, one thing was certain, I did believe that there was a "key" to the proper way to teach the alphabet to an autistic child and as such, this was one area that needed great study since it was truly the one key to unlock all communication!

This theory as to the fact that there was a "right way" and a "wrong way" to teach the alphabet to autistic children certainly explained why some children acquired language and others did not. Some of us may use tools to teach the alphabet that showed the entire thing all at once... like a poster... while others try to use books... a constant source of frustration for the autistic child who has not figured out that a whole (a book, or the alphabet) was made up of its parts. Some parents used a pen... with a single color... others used wooden puzzles with multiple colors. The fact was that there was enough variation in "how" parents tried to teach the alphabet to truly explain why some children "got it" and others "did not.

For Zachary, once the alphabet was learned, and each letter had been associated with a symbol and a sound (as in the alphabet song), the concept of "a label", a "symbol" representing something had now been solidified. All of a sudden, I simply had to label something once, and Zachary remembered the label... he remembered "the association" of "this label" for "that thing". I easily took the concept of a "label" for each letter "off the wall" and started to apply it to everything in life.

## Phonics

I was convinced that the autistic child had an inability to process partiality and as such, unless the "parts" of the "whole" were understood, the "whole" (i.e., words or utterances) could not be understood.

A "normal" child learned that a "dog" was this funny thing with fur and a tail. That, if mom pointed to "a dog" and said: "dog", the lesson had been learned... the label given, the association made. For a "normal child", the association was simple. But, I was of the opinion that for an autistic child, the "association" as to "what a dog was" could not be made until the "word itself - the label of dog" was first figured out. I was not saying that each label must first be understood before an association could be made. What I was saying, however, was that in the beginning, as the autistic child was just embarking on his journey to learn language, the concept of "where a label came from", first had to be understood.

Once the concept of "a label" was understood... then, the child would easily learn any label given. To understand where the "label" came from, the autistic child first had to understand the phonics behind the label... the sounds that made up the label. To understand the phonics behind the label, the autistic child first had to understand that letters had sounds. To understand the concept that letters had sounds, the autistic child first had to understand that letters were symbols that represented something... and that this "something" was the code that needed to be broken!

To say: "dog" to an autistic child who did not have an understanding of "the code" behind language (the alphabet) provided for him only an utterance he could not understand. This utterance... "dddddogggg"... what did that tell the autistic brain? In my opinion, not much! There were "sounds" there, but to the autistic child they were "meaningless sounds" since he had not been taught "the breakdown" of each sound, what it was, what it "said", what it "meant", "how to put the sounds together", etc. But, if the child was first taught the alphabet, A, then B, then C... there was order there. Then, the child could learn "A" says "a" (as in apple), sometimes "a" (as in cake), "B" says "buh", and so on, then, there was order there, something the child could relate to... and not only was order provided but in understanding the alphabet, the code was literally broken to unlock all other aspects of communication!

I spent a great deal of time just "labeling" everything for Zachary... that had its good points and its bad points. The good was in that Zachary had the opportunity to identify "more parts of his world". The bad was in that I was so focused on having him "talk", that I failed to see the "concept" had already been learned...the concept of labels... and so, once learned, he was ready for the next step. I did not see that until much, much later. I spent a great deal of time just "labeling" when I should have been moving on to phonics!

It was fine to label as many things as possible... but once the "concept" of labels had been learned the child would easily learn "all the labels" when they were uttered... and so, the focus now needed to turn to "the next step"... to not stay in the "trap" of simply labeling. It was wonderful to hear Zachary say each and every new word, but, for him, saying new words was not the issue once that "task" or "concept" was learned... the issue was to move on and show how "that part" fit into the next step in communication and the rest of the whole... to eventually move

toward actual conversation. Zachary could grasp a concept very quickly... and so, it was always important to remember going forward, to "move on" and not stay fixed on one task once that task or concept had been learned (as in this case, "labeling").

It was probably close to 8 months later that I, personally, came to the realization that Zachary was able to "move on" to go to the next logical step in language... phonics. This was one of those: "If only I had seen this sooner... he could have moved on more quickly" issues for me, and I suspect many parents.

I had parents tell me that even though their child knew his letters, schools often recommended not bothering to teach phonics until in the appropriate grade. Parents whose children were in pre-kindergarden and knew the alphabet for example, were told to wait until kindergarden or even first grade before tackling phonics. I could not disagree more!

Once the autistic child had mastered the alphabet, parents needed to move on as quickly as possible to phonics. Waiting for "other kids" was ridiculous. The autistic child needed to move forward as quickly as possible in those areas of strength... where the code had been broken, because unlike other children, he would be much more challenged than his peers in areas that did not have an "obvious code" - areas such as socialization and conversation.

While "normal children" were still learning the alphabet, the autistic child who had mastered it at an earlier age could then use "that time" to focus on areas of weakness instead of being bored reviewing something he already knew and more importantly, falling further behind in areas that were already more difficult. I saw absolutely nothing wrong with pulling an autistic child out of class when his peers were learning concepts he already knew... and putting him in a class with younger children to work on issues with socialization, etc. Schools may not particularly like this suggestion, but, this was not a matter of what was "more convenient" for the school... it was a matter of "what was in the best interest of the child"!

I had wasted a lot of time by not "moving on to phonics" and I hoped that other parents would avoid making this one mistake I very much regreted in terms of how I worked with Zachary on language issues! I finally did realize my mistake, however.. and there was no "more" time to be wasted "feeling bad" about that... it was time to move on...for both Zachary and I.

With the concept of "symbols" learned - symbols as "things" representing letters, shapes, numbers, I then decided to focus on [phonics](#). Note that this "next step", in our case, did not involve "pictures" or flash cards of any kind. Pictures were still only part of the concept of symbols... and once that concept had been taught, even if only with the alphabet symbols, the next step to language in my opinion, was phonics.

Picture symbols could be used to expand the child's knowledge of symbols, but in my opinion, once the alphabet was recognized as "a code" and the concept of "this represents this" was learned, it was time to move on to the next concept – phonics! Undoubtedly, in autistic children, communication could occur without an understanding of "the alphabet" first, as had been expressed by many parents who said their children could read but had no concept of the

alphabet, but without that understanding progress was far less effective since the "code" to communication had yet to be broken.

Systems using "words" or pictures on cards were not the best way to start teaching communication to the autistic. Sure, over time, you could certainly make a child memorize that the letters c-a-t spell "cat", especially if reward systems were used and have the "association" made, however, I think it was much, much more productive to go the way of the alphabet and then phonics...based on a very specific teaching method that involved teaching the alphabet as a "whole" via the use of colors, etc., because for the autistic child, in my view, it was a matter of simply teaching "the concepts" behind language - of helping the child "break the code" - and once the code was understood, the child would understand all "picture/word associations" - 10 pictures or words would be no more easy or difficult than 1000 because once the "concept" was learned, the autistic child could easily generalize it to understand "all similar things"... in this case, all picture/word associations! I was convinced there was a right way and a wrong way to teach the concept of the alphabet. This was what I had found to be true in my own son, Zachary.

Zachary knew his alphabet, now our focus would be phonics!

I wondered about the best way to teach Zachary phonics for about 5 minutes... and again, I think I just "stumbled" upon the best way right from the start.

So, how do you teach phonics to the autistic child? Surprisingly, for Zachary, it had been much simpler than I would ever have imagined. It had not been that hard and I did not need a lot of expensive materials to do it. It had been quite the opposite actually!

I now knew for a fact that Zachary knew his letters, so I simply took each letter and went through the alphabet saying: "A" says "ah" (as in apple), sometimes "a" (as in cake), "B" says "buh", C says "cuh" sometimes ssss (as in city). Note: I never told him the "as in" part I provide here in brackets... I just provided **the letter and the sound**... if more than one sound existed for the letter, I would say the first sound, join it with the word "sometimes" for any additional sounds: So, for example, I would say: A says ah, sometimes a. That's it.... nothing else... no other words, no associations (for example, "as in apple"), etc.... just the sounds for each letter...THE SOUND ONLY - THAT WAS IT! I gave "the letter – the sound" only – the lowest level to phonics – with no "word examples"!

In no time, Zachary could rhyme though the entire alphabet providing me with the appropriate letter sound(s) for each letter. Below, I have provided in table format how I taught Zachary his phonics verbally.

There were a ton of materials out there to teach children phonics... and some were rather expensive. However, any person who knew how to read knew the letter sounds... and so, I provided those I used for Zachary in the tables below. Teaching the concept of "letters having sounds" was all that I wanted to do... and that, I could do without a book or fancy materials.

Below, I provided each basic letter sound for readers as well as consonant blends and digraphs most often used. These provided more than enough to get any parent started with phonics. For vowels... I did not provide the "label" of short versus long until much later... I ended up trying to do that later on... although I found that once Zachary knew the sounds, it really did not matter if he knew "this was a long a or a short a"... most adults do not even know that. :o) For those parents who did not know the difference between short and long vowels, the mystery was simple: if the letter sounded like the "letter of the alphabet"... that was the long sound for the vowel - the other was the short vowel sound! In terms of Zachary knowing the difference, this was not a "biggy" in my book as far as having to teach that right away. Teaching the label of "short" versus long could come later... after all, anything having to do with "labels" was quickly learned by Zachary, and so, I knew this would not be a huge stumbling block later on.

Basic letter sounds were as follows - remember, I would not "say out loud" anything I provided in brackets.... **I said just the letter and the sound** - that was all I provided for Zachary... with a "sometimes" if there was more than one sound. This was key to Zachary quickly picking up the concept of phonics. Also important was to note that for Zachary, I taught phonics "by ear" not "by sight".

By that I mean that I did not use flash cards or other materials (paper, blackboards, etc.) of any type... I **sounded** out each letter sound(s) for him. The reason I believed you had to "sound" out the phonics was because, again, flash cards, pictures, associations, etc. brought additional "parts" to the situation whereas letter sounds were just that... basic sounds - so there was no "additional interference", no unnecessary distractions to the lesson being taught!

Also, keep in mind that most phonics materials out there may not teach phonics "in order of the alphabet"... taking each letter, in the order it appeared in the alphabet, and providing that letter's sound(s) one at a time - in the correct order. Doing phonics the way I did them below, in alphabetical order, provided for Zachary that continuation of the parts making the whole... the alphabet letters making a sound... later on, I could easily "mix them up" for him.

For parents who wanted to try teaching their children phonics, I encouraged you to practice a little with the chart below before actually undertaking the task. You wanted to be fairly "fluid" as you start calling out the letters and their associated sounds. I learned that the "hard way" and found it confusing even for me to keep this straight before I had gone through this a couple of times... I wanted to keep the long and short vowel sounds, for example, always in the proper order... always saying the "short" sound first, and then the long sound. I knew that would later help Zachary understand the difference... that the "long sound" was always the "second one mommy said for that letter", for example.

Although I had not personally used The Phonics Handbook by Sue Lloyd (ISBN 1-870946 08 – 1) in the sense that I did not teach Zachary phonics using this method involving motion, in writing this text, I did look at the Phonics Handbook for "the basics" in terms of "sounds", "blends", etc. As such, although I just used the "letter + sound" approach to teach Zachary phonics, the information provided in this section based on "sounds to use" and "what the basic sounds were" in terms of things like blends, etc., was very much information from materials provided in the Phonics Handbook, by Sue Lloyd.

For those parents interested in purchasing this excellent guide, the reference for The Phonics Handbook was as follows:

Lloyd, Sue, The Phonics Handbook, Jolly Learning, Ltd, 1996 (ISBN 1 987946 08 1).

As I reviewed the information in this book as I wrote this text, I soon came to realize that this text was indeed a fantastic tool for the autistic. As such, if there was one “book” I felt to be “the best” for teaching language basics in children with autism – without a question – this was it!

Thus, even though my materials “looked different”, much of the content in the information provided in this section was based on materials put together by Sue Lloyd in her Phonics Handbook – a handbook that in my opinion, was one of the best tools on the market for teaching language in all children, but in my opinion, one of the very best tools especially for teaching language in the child with autism or any other person having difficulty in either producing or understanding language. I had not used the “motion” in her teaching materials with Zachary, but I had used the basic “phonics information” in terms of knowing for example “what blends to teach”, etc. and as such, much of her information was included/integrated in what “I had done”. Granted, I had used other phonics materials also, but, without a doubt, if I had to “go back” and “start over” with Zachary, I would have made greater use of materials presented in this text.



What you want to know to say before you say it for the child...again, most of these words come from Sue Lloyd's Phonics Handbook (ISBN 1-870946 08 1). I encouraged parents to use words their children especially loved (i.e., for Zachary, I used "t is for truck".	How it should come out when you say it for the child... make the appropriate letter sound based on the example to the left!
A says "a" (as in apple), sometimes "ay" (as in day)	A says "a", sometimes "ay"
B says "b" (as in bat)	B says "b"
C says "k" (as in car), sometimes "s" (as in city)	C says "k", sometimes "sss"
D says "d" (as in drum)	D says "d"
E says "e" (as in egg), sometimes "e" (as in bee)	E says "e", sometimes "ee"
F says "f" (as in fish)	F says "f"
G says "g" (as in girl), sometimes "g" (as in George)	G says "g", sometimes "j"
H says "h" (as in hat)	H says "h"
I says "i" (as in pig), sometimes "i" (as in I)	I says "i", sometimes "I"
J says "j" (as in jump)	J says "j"
K says "k" (as in kite)	K says "k"
L says "l" (as in lip)	L says "l"
M says "m" (as in man)	M says "m"
N says "n" (as in nest)	N says "n"
O says "o" (as in off), sometimes "o" (as in open)	O says "o", sometimes "oh"
P says "p" (as in pig)	P says "p"
Q says "q" (as in quack)	Q says "qu"
R says "r" (as in rat)	R says "r"
S says "s" (as in snake) sometimes "z" (as in because)	S says "s", sometimes "z"
T says "t" (as in top)	T says "t"
U says "u" (as in up), sometimes "u" (as in you)	U says "u", sometimes "you"
V says "v" (as in van)	V says "v"
W says "w" (as in water)	W says "w"
X says "x" (as in fox)	X says "x"
Y says "y" (as in yellow), sometimes "y" (as in sky)	Y says "y", sometimes "i"
Z says "z" (as in zebra)	Z says "z"

I sounded the letter sounds out for Zachary a few times... always working my way through the **entire** alphabet. Since Zachary knew "of the alphabet", he understood its parts... he understood the alphabet started with "A" and ended with "Z"... and so, I wanted to provide the continuity from A to Z without stopping in the middle. In fact, if I did stop in the "middle" Zachary got upset and I had to continue until the entire alphabet had been completed. Within a day or two, I then started to ask him to tell me the sound... and he could! I would call out the letter and say, for example: "A says..." and he would complete the phrase by providing the appropriate sound... if there were more than one sound for a letter, after he said the first, I simply added "sometimes..." and he completed the phrase by saying the second sound. Soon, he could do so even when I "mixed them up"... he had learned the lesson... each letter had a specific sound(s) associated with it... that was all that mattered. Once the concept was learned, it was understood

and the concept of "letters having sounds" could now be generalized to "combined letters"... or words! Once Zachary understood and knew the basic letter sounds, more sounds could then be added... in the form of short words and later basic blends and digraphs. Basic blends and digraphs were provided below. Again, I taught these sound in the same manner as shown above.

Once Zachary knew his basic letter sounds, these came easily - the concept was the same... each letter had a sound, so it was just a matter of putting the sounds together. For digraphs (like "ch", all I had to do was say: "c, h says... and say the sound"... that was all it took! The basics blends taken from Sue Lloyd's The Phonics Handbook included:

bl, br, cl, cr, dr, fl, fr, gl, gr, pl, pr, sc, sk, sl, sm, sn, sp, st, tr, ch, sh, th, wh, kn

So, for all of these, I proceeded just as I had with the letters... For example, I would say:

K N says N (as in knee)

Note: I could have easily used the concept of equations to teach this same thing, but I saw a problem with that. For example, if I said:

$K + N = N$

Zachary would catch on to that too... but, the more I thought about that, the more I thought equations should be kept for learning math as much as possible... for me to introduce the concept of an equation here may confuse him down the road... that was still too far ahead for me... but, something I did want to mention. So, my preference was to use: KN says N.

Then there were a few more complicated sounds to learn - again, this information was based on that provided by Sue Lloyd in The Phonics Handbook.

What you want to know to say before you say it for the child... again, these were words from The Phonics Handbook by Sue Lloyd – I provided these for example purposes only and encouraged parents to use words they knew their children seemed to “really like” or “already knew”.	How it should come out when you say it for the child... make the appropriate letter sound based on the example to the left!
AR says "ar" (as in car)	AR says "ar"
CH says "ch" (as in chair)	CH says "ch"
EA says "ea" (as in read -past tense), sometimes "ea" (as in pea) - basically the same two sounds as the letter "e" above	EA says "ea", sometimes "e"
EE says "ee" (as in bee)	EE says "ee"
ER says "er" (as in her)	ER says "er"
IE says "ie" (as in pie)	IE says "aye"
OA says "oh" (as in goat)	OA says "oh"
OI says "oi" (as in coin)	OI says "oi"
OO says "oo" (as in foot), sometimes "oo" (as in moon) (both a short and a long to this one)	OO says "oo", sometimes "oo"
OR says "or" (as in for)	OR says "or"
OU says "ou" (as in ouch)	OU says "ou"
NG says "ng" (as in song)	NG says "ng"
QU says "qu" (as in quack)	QU says "qu"
SH says "sh" (as in ship)	SH says "sh"
TH says "th" (as in that)	TH says "th"
UE says "ue" (as in cue)	UE says "you"

Finally, certain sounds could be written in more than one way:

For example, for each of the ways in which the sound could be written, I would say to Zachary:

ER says "er".

IR says "er".

UR says "ur".

So as to not confuse a child too much, however, I recommended either introducing these on separate days, fairly far apart or using an equation system as shown in this table. Again, these "basic sounds/words" were taken from materials put together by Sue Lloyd in The Phonics Handbook.

SOUND	CAN BE WRITTEN AS
ER = IR = UR	ER, IR, or UR (as in never, bird, fur)
AW = AU = AL	AW, AU, AL (as in jaw, August, talk)
OI = OY	OI, OY (as in coin, boy)
OU = OW	OU OW (as in loud, cow)

Note that the important thing in the “equation” was to emphasize to the child that the sound was equal even though the spelling was different. Zachary could easily grasp that concept.

This provided enough on "phonics" to get all parents started on the task of teaching phonics to a child.

As mentioned earlier, the one thing I had not noticed until almost the completion of this book, was the fact that in teaching phonics, although I had not realized it at the time, motion had also played a part... in that Zachary had learned his letters via his Alphabet Train video... a video that involved considerable motion. Thus, in my view, the alphabet had to first be taught using motion, and color, and then phonics would come easily!

**I had not personally used The Phonics Handbook to teach Zachary his “first phonics” – the “basics before blends”, although I did go back later to use the information provided in this text to supplement what I had done. My sister-in-law had used this method and for her child, it had worked wonders. So, for Zachary, I knew that “the motion method” described in this text had not been involved in teaching him phonics. Clearly, for Zachary, the “sounding out” of phonics had been how he had learned “basic phonics” at first. Yet, the more I came to understand, the more I saw why The Phonics Handbook and its “motion method” was absolutely key. The critical link between The Phonics Handbook and the “alphabet train video” was that of MOTION! The Phonics Handbook used hand motions to teach sounds...the Alphabet Train video used motion to teach the concept of letters and their names. Motion – I was convinced was – like sound – a KEY element in teaching both the alphabet and phonics and I suspected, that in teaching the alphabet, color had also played a critical role for Zachary!**

The one thing I did forget to mention in my first book ([Saving Zachary: The Death And Rebirth Of A Family Coping With Autism](#)) as it related to phonics, was that I also used a video called: Learn To Read With Phonics/Mrs. Phipps and Snoothy. One website that sold this video was <http://www.videolearning.com/S0702.HTM>. This company sold over 15,000 videos. The one I was talking about was item 10-7060. This was an absolutely excellent video for teaching letters and phonics. On this video, letters were written out carefully to show the child exactly how the letter was made (upper and lower case) and each letter's sound was then clearly given. Zachary did watch this a few times, but he really got the idea behind phonics simply by my calling out the letter sounds as done above. The video was simply something I used to reinforce the concept of

phonics while I got to relax a little. This video costs \$30.00. You may want to check with your local library ... or local schools. If they do not have these same products, they probably have at least something similar... Zachary knew all his letter sounds before watching this video simply based on my “sounding them out”... but, this video was good in that it also carefully showed how to make each upper and lower case letter too! So, the phonics video had not been involved in his actually “learning” the phonics.

Finally, once Zachary knew these sounds for "letters", I could then move on to the next step... WORDS! Another great resource from Mrs. Phipps for this topic is:

Learn To Read: Volume 2 This video dealt with soundable words, repeated vocabulary, word groups and word families. Five stories were acted out by children as Mrs. Phipps sounds out each word as it appeared on the screen, read the sentence, and then allowed time for the children to read. This was item no. 01-4203 (65 min. \$ 29.95). Although I had not personally used this one, another parent of an autistic child suggested it as an excellent video, too!

Buying resources such as these can get rather expensive. As such, I encouraged parents to split the cost of such materials among support group members, etc. and to “create your own library as a group”. I also would not “stock up” on a ton of resources until you knew your child had mastered the first levels that needed to be mastered before moving on to the next and buying the “resources” for that.

## Words!

Words were easy to teach once phonics had been mastered. I just wrote a simple word, like "cat" or "dog" and ran my finger under each letter as I put the "sounds together" for Zachary. I remembered how Zachary's face totally lit up when he finally understood exactly "where words came from"... these symbols, letters bunched together or "words" that were everywhere in his world... he now understood. Another huge piece of the "language code" had been broken for him. He finally understood how it "all fit together".

After the concept of words had been taught, I worked with a few flash card sets simply to reinforce reading ability. I found at first I greatly underestimated Zachary's potential in terms of reading. I, like all parents, started out with words like cat, dog, etc. I soon realized that Zachary was capable of much, much bigger words. That realization came to me when I awoke one morning to the sound of Zachary reading a label in my bedroom... a label he saw on the television... with perfect pronunciation, he read: "Panasonic". Again, it was just a matter of learning the concept... and once the "concept" was learned, he could easily generalize it to any word and moved forward quickly in terms of his ability to read.

So, from then on, I knew "big words" were ok too. As long as Zachary knew the phonics, he could pretty well make out the word. I now used flash cards to teach new words. A company called Frank Schaffer Publications made the flashcard set I liked the most. You could buy various sets of flash cards (I had 3 sets) with the word on one side and the picture on the other. The sets I had were for 1) action words (product no. FS-3214), 2) picture words (product no. FS-3205), 3) blends and digraphs (product no. FS-3210). These were excellent products for the autistic child. I simply picked them up at a local school supply store. Any school supply store should be able to order these products as this is a fairly large school supply company and it was very well known. I looked for their website, but could not find it off hand. If someone did find it, please forward it to me via my website and I will provide it for all parents on my website.

With these flash card sets, Zachary greatly rejoiced whenever he could make out a word and I would flip the card over to show him the picture. Seeing the picture when I flipped the card for the word he read acted as "the reinforcement" to go on. I did not have to use food or anything else to get him to read once he understood the concept that letters had sounds, and when sounds were put together, they made words... and words labeled things. That all important label provided what he so desperately needed to begin to cope with so much in his environment... and for Zachary, "breaking the code" provided plenty of reinforcement in and of itself!

Zachary's face showed an immense fascination when I put the "letters" and "sounds" together to "make things".... "words". It had been like seeing a little light bulb turn on when he figured out that letters had sounds, and sounds, put together made words, and words provided labels for things... and these labels helped understand "everything else". I literally saw the amazement in his eyes and the joy in his face when he figured that out with the first word he read: C-A-T. That critical "connection" had once again been made!

In no time at all, almost overnight, he had developed the ability to read! In looking back, I spent a great deal of time, just labeling things. A whole new world had opened up. I was so happy that Zachary was finally "talking"... or so it seemed!

## Talking In Labels and Commands ... "Reference" Communication...

### The Autistic Child's Preferred Ways to Communicate!

What I failed to realize for a long time was the fact that **all** of Zachary's speech now simply consisted of labels (words) and/or commands. He knew "what certain things were" and he had figured out that basic commands always produced the same outcome... commands like: "juice please", or "let's go". There were also the "yes" and "no". Because he could respond with "yes or no", I made the mistake of taking this for "conversation" for a long time. His world became one that consisted completely of labels, commands and one word answers...these I came to understand were just variations of "labels"... not actual conversation. Conversation was still very much absent.

I now truly became aware of the fact that, for Zachary, "talking" was in "labels and commands". I realized that like labels, specific commands represented or "produced" very specific outcomes. "I want water", "open the door", "let's go walking", "car ride"... as did "yes" and "no" - all of these things produced very specific results... and the results were always the same. Thus, all these things, to Zachary, were no more than variations of "labels". It took no time at all for Zachary to figure out the fact that like labels, commands and "yes" or "no" always produced the same outcome... it had taken me much much longer to actually see that for Zachary, these were just extensions of "labels". Labels, commands and one word answers quickly became his "preferred" mode of communication... not only did they produce a specific result, but he could "get things" through commands and "have someone else do the work"... positive reinforcements indeed... for more than just the autistic child! :o)

Labels, commands and one word answers provided for Zachary concrete things and as such, he quickly learned to "tuck these away" for future use... what I have come to term "reference communication"! Reference communication was something we all do, but, for the autistic child, "reference communication" can become a huge tool as the child continues to "decode communication", as we will see under the language section addressing how to teach conversation and the concept of a "sentence" to the autistic child.

**Reference communication** played a **critical** role in terms of helping the autistic child understand "[Safety Issues](#)". I strongly encouraged all parents to read this section, for in areas of "safety", incomplete or inaccurate reference communication can be a matter of life and death!



## Conversation

As I read more on parent discussion boards, it soon became evident that although Zachary knew a ton of words, the fact that he spoke in labels and commands meant he was still “non-verbal” in that actual communication still was not there. I soon realized that the term “non-verbal” was a term that meant many different things to many parents. In my view, “non-verbal” should mean that a child only had a few words or none at all. “Non-conversing” was a more appropriate label for children like Zachary – children who had a wonderful vocabulary but still could not carry on a conversation. As much as I hated all labels, at least this one was more appropriate.

I now needed to figure out how to "get" actual conversation from Zachary. Coincidentally, another factor would fall into place just at the time I needed it to.

Zachary had been on a supplement called TMG (a Kirkman Labs product) for close to two years now. Kirkman Labs specialized in products for the autistic. This particular supplement was supposed to help trigger language in autistic children, and I did suspect it did do that for Zachary - initially. I ended up running out of TMG in early July of 2002, just as we were leaving for a trip to visit relatives in Canada and, at the time, I decided that since Zachary was now on [enzymes](#), I would no longer use the TMG and see how that went. TMG had a pretty strong dose of vitamin B in it and from parent discussions on the enzymes and autism Yahoo group, <http://groups.yahoo.com/group/enzymesandautism/>, I came to see that many parents felt their children could no longer tolerate TMG and other mega-dose vitamin products once their children were on enzymes. Enzymes helped to better break down food and supplements taken in by the autistic child, and as such, fewer supplements seemed to be necessary.

To my utter amazement, within a couple of days of being off the TMG, Zachary actually started to show more conversation... more actual responding to questions using more words. I could not believe it and thought it was just me... until others noticed it too. I did not know if this was just a "fluke" or if there was more to this... but I did know, that for Zachary, conversation started after I took him off the TMG. I wondered as to why that could be. I had never seen any studies on the long-term use of TMG and the result of then "going off the supplement"... so, I really had nothing to go on... just this one observation... in my own son.

Like other parents, I suspected that the enzymes did indeed allow Zachary to absorb more of his supplements and that perhaps now, he was actually getting too much Vitamin B. I had also removed the Super Nu Thera from Zachary's supplement list, again, based on comments from other parents who stated that "mega dose" vitamins had negative effects on their children once they were placed on enzymes. I had learned enough the hard way... so when the enzymes went in... the Super Nu Thera went out... it was only a couple of months later that the TMG ran out. I had placed Zachary on a regular ckgf (casein free, gluten free) multivitamin and so the TMG had been providing an extra dose of Vitamin B he probably no longer needed once on enzymes.

Again, this was simply a theory based on what I observed in my son - but literally within days of being off TMG, Zachary started to show signs of the ability to hold a conversation... it could have been a "fluke", "a coincidence", but I had no way to know either way.

At the time of the writing of this text, Zachary has been off TMG for about 2 months and his conversation skills were truly improving. This was the point at which we were. But, we had made progress even in the last month and so I wanted to share with parents my ideas/thoughts in this area as well... in terms of how I was tackling the whole issue of conversation based on what I had come to understand in terms of the autistic child's inability to process the whole without first understanding the parts that made up that whole.

The challenge with conversation was that it was random... it had no order. So, how do you even begin to bring order to something that had no order? How do you break down the "parts" to a sentence, for example, so that a very young child could understand how the "parts" of a sentence "fit together" to form a sentence and that sentences were then put together to form conversation.

I had noticed for a long time that if I asked Zachary to repeat a sentence, he could repeat the first few words, but then, the rest got all "garbled" as he tried to recall and repeat it. Why was that, I wondered?

Well, if you think about this issue of language in terms of the autistic child's inability to process the partial, what I believed to be the root cause of almost all their problems, then it all started to make perfect sense.

Letters, sounds, words... all of these, in and of themselves provided a "label" of some kind. For example, "A"... this was the letter "A"... that letter was now recognized as an entity in and of itself once it had a label specific to it and it only. The same was true for sounds and words... they provided "labels" for things and became entities in and of themselves... the "part" had now taken on a whole and so, it now became very, very easy for the autistic child to communicate in labels because these "names" for things define specific objects... whether those objects were "wholes" or "parts" of something else... the label made objects entities in and of themselves.

For example, the label "1/2" took a "partial" and made it "whole" ... the label 1/2 made the fraction, "the part", an entity, a "whole" in and of itself... something that could stand alone and be recognized as "1/2".

If indeed the autistic child had trouble with the processing of the parts making up the whole, as I firmly believed to be the case, it made perfect sense that a "sentence" would only appear as a bunch of incomprehensible "parts".... that until the child was shown the labels to those parts and shown how the parts fit together, that conversation would not come easily.

I thought a lot about this issue - how could I make such a young child see the "parts" to a sentence? To show the "parts" to the sentence, I would have to somehow "compartmentalize" the various "parts"... to allow Zachary to see individual parts first, and then to see them come together to make a sentence. So, how do you do that?

I came up with an idea... but I must admit, for quite a while, I debated as to which step should actually come first... the labeling of words as nouns, adjectives, verbs, adverbs, etc., or the physical representation of a sentence in compartments to show the "parts of the whole". I had not thought about teaching the concept of a noun, verb, etc. to a 5 year old... and so, I simply

decided to go with the concept of "compartmentalizing" the sentence visually for Zachary. I knew Zachary quickly grasped labels and so I felt the "concept" of breaking the sentence down into its parts visually should come first, and the labels to those parts, second. Once the "parts" were "there" visually represented, I could then worry about labeling them accurately later on. Partial labels would be enough for now.

As with everything, when it came to working with Zachary, I always went with my instincts as to which way to go. I had figured out a long time ago that the "voice" within me was there for a reason... and mothers, in particular, seemed to have been given a fantastic sense of instinct when it came to caring for their children.

The reason I decided to go with visual compartmentalization before providing labels for words (such as nouns, verbs, etc.) was very much in keeping with my theory that the true problem was first and foremost one of processing the parts to the whole... and that once those parts were understood in terms of how they related to the whole, labels would come easily. If my theory was correct, an autistic child would not be able to "label word types" (i.e., a noun, a verb, etc.) until he first saw how the words made up the whole... the sentence... and for the autistic child, the best way to do that, was via a visual representation and compartmentalization of "a sentence".

So, how do you put a sentence into "compartments"?

### Sentence Compartmentalization Via Bubble Graphs

The answer was in what I called "bubble graphs". This concept was based on something I myself had learned when I was in 4th grade. I modified the concept to make it more applicable for the autistic - specifically! I did not believe this concept was still taught in schools, but it was a fantastic way to teach the "parts" of a sentence... for any child - autistic or not!

Before we get into the concept of bubble graphs, I wanted to emphasize to all parents to read my section on the importance of [colors](#) in the life of the autistic child. I believed that colors and shapes added extra elements or "parts" to bubble graphs that further help solidify the "compartmentalization of a sentence" for the autistic child... and as such, I would encourage all parents to make use of colors and shapes if they decided to try this. Note that sentence parts should have the same color and shape. For example all information related to the subject should look the same in terms its shape and color used. This in my opinion, helped to group that sentence part into a whole of its own... apart from the rest of the sentence. As such, I decided to use the following shapes and color codes with Zachary:

Red oval = subject info (article, subject, adjective), blue square = verb info (verb, adverb), green rectangle = object of the verb info or object of the preposition (depending on how technical you want to get at this stage – answers who, what, when, where, why, how – here, it was “how” in the sense of, for example, pulling with something verses the “how” you would see as an adverb, such as “pulled slowly”), brown hexagon = preposition info, purple cross = conjunction info.

Note: There were two types of bubble graphs presented for each sentence in the examples below... part “a” and part “b”. There was a tendency to move on to “part b” quickly – perhaps simply because these bubble graphs were so much fun to do – but, as with everything in teaching the autistic, I believed the concept presented in “part a” had to be well understood first, before moving on to “part b” and actually trying to “break out” the bubbles for labeling purposes. The key in everything was always to make sure the lowest building blocks were well laid before moving up in terms of going on to the next concept. If the lower building blocks were not properly laid the foundation to teaching language and conversation would not be as strong and as such, I wanted to caution parents against the inherent desire to “move along quickly”. I found I came much better at gauging Zachary’s pace in this area... I did not want to move too slowly (as I had done with labeling), but I did not want to move too quickly either (as I had done with teaching money – see Teaching Money section for more on that and how I think this needs to be taught)! :o)

### Using The Bubble Graph Concept...

#### To Show How The Parts (Words) Fit Together To Form The Whole (The Sentence)

I used the following three sentences in working with Zachary - the first being the simplest, the last, the most difficult.

1. The train pulled into the station.
2. The long train pulled slowly into the station and was loaded.
3. The long steam train pulled slowly and carefully into the station and was loaded with logs, cars, trucks and coal.

The first sentence would be represented as follows in a bubble graph:

#### 1a. The train pulled into the station.

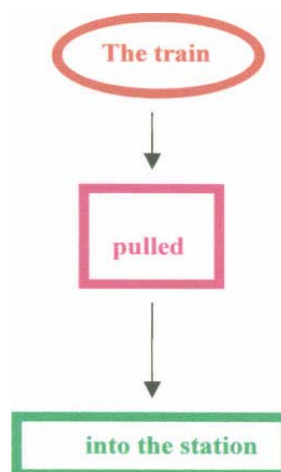

Before I went any further, I provided a basic list of prepositions and conjunctions for parents as basic review. Teaching this concept to Zachary necessitated I have a basic understanding of grammar... nothing complicated... just the very basics! :o)

## Prepositions And Conjunctions

Prepositions include: above, across, after, around, at, before, behind, below, beside, between, by, down, during, for, from, in, inside, into, of, off, on, out, over, through, to, under, up, with.

Conjunctions include: and, but, or

An excellent reference/workbook for parents was that of Wanda C. Phillips' "Easy Grammar" series: <http://www.homeschoolbooksource.com/EasyGrammarDailyGrams.html>. It provided a basic overview for grades 2/3 that went over key grammar concepts. But, any basic grammar book would do if parents felt they needed to "brush up" on grammar.

There were several key things the "bubble graph" representation did for the autistic child. Actually, this concept could be used for any child... and as such, would be an excellent way to help integrate the autistic into classes with their peers.

This graph took the sentence and broke it into pieces... its parts!

Note: When I was young, all we used were "bubbles" or ovals... I varied that concept a little, because I thought that a different shape and colors for each "word type" or "sentence part" would be more useful to the autistic child. Variety in shape and color, I believed, would truly help reinforce these concepts.

Also note that I showed "ideas" as parts to the whole. For example, the concept of "into the station" was left together... it conveyed **one** idea... and answered one question: The train pulled where? Into the station. This should greatly help with further sentence analysis in terms of actual labeling, etc., later on. Likewise, at this point in time, the subject information was all left into "one bubble"... the words "the" and "train" belonged together. By doing this, I hoped to help Zachary group ideas or concepts. I could then pull them out when it came time to label the "types of words". For now though, in order to understand conversation, what mattered was the understanding that sentences were simply small "parts" lumped together and that each "part" consisted of an "idea".

When the time comes to label the parts, this sentence would look as shown below in 1b... again, I believed "part a" had to be mastered before moving on to this level.

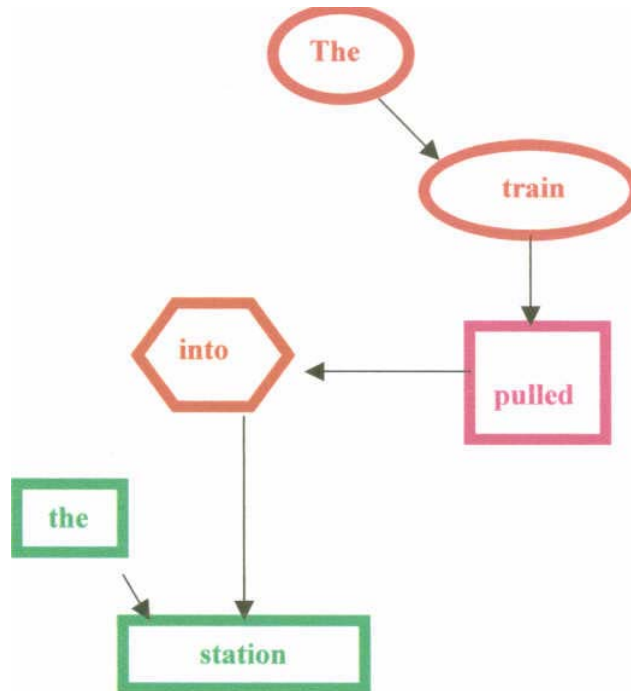

What the bubble graph concept did was that it provided a means by which the child could mentally compartmentalize a sentence as it was being said... and I hoped that this would help Zachary, and other autistic children to remember what had been said more easily during actual conversation or teaching. The concept was really quite simple and it was one I could build on as the sentence became more and more complicated and as the Zachary grew and learned more about grammar... about the concept of prepositions, conjunctions, phrases, etc. The key for the parent was just to start doing as much "labeling" as possible... to start with the basics and then to expand from there!

For example, in sentence no. 2, the sentence was slightly more difficult. Here, I added an adjective (long), and adverb (slowly), a conjunction (and) and another verb (was loaded). In spite of the greater difficulty, however, the concept remained the same.

2a. The long train pulled slowly into the station and was loaded.

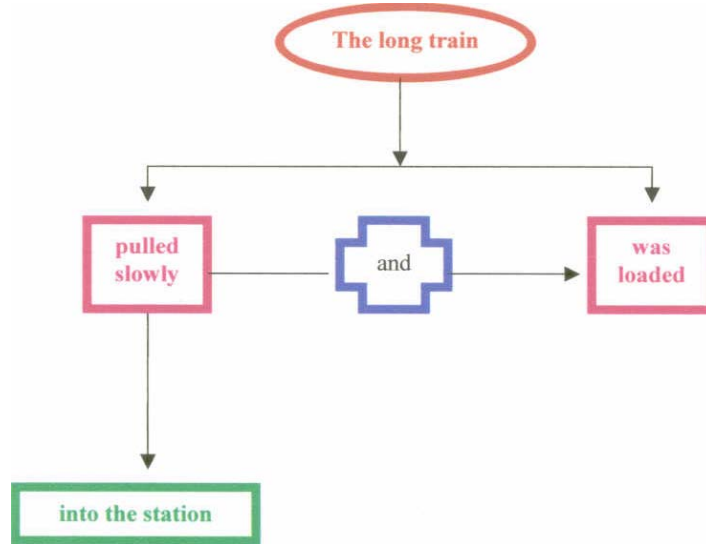

So, this was basically, the same concept as in sentence 1... with just a few more words added. As far as the "and was loaded", this was where I was taught the "second verb" should go when I was a child. However, if that was too confusing for Zachary, I would not, at this point, have had a problem with moving the arrows to go from "into the station" to "and was loaded" instead of in between "pulled slowly" and "was loaded". The idea was just to get Zachary to "grasp" the ideas in the sentence. To try to develop conversation, I just wanted to ensure the concept of "compartmentalization" of parts (words/phrases) to the whole (the sentence) was understood.

Expanding sentence 2 for the "labeling stage" would give us 2b as shown below (again, this only needed to be done much later... when Zachary was fully comfortable with part "a" of graphs 1, 2 and 3 - and understood the concept of compartmentalizing "ideas" very well):



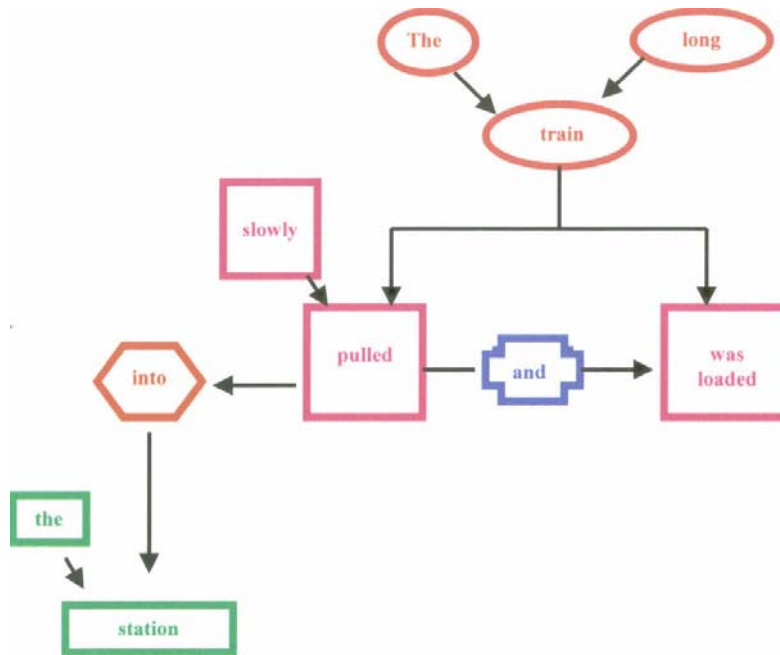

Now, each part of the sentence could be labeled for Zachary. Again, labeling, in my view would come after the concept of "ideas" within a sentence was learned. In school, most children probably learned this stuff in 2nd or 3rd grade. Since Zachary was only 5, I figured I had time (although, at the time I started doing these exercises with him, again, my enthusiasm got the best of me – again!). But, as I was practicing all these graphs with him, I tried to make sure I labeled for him as much as I could as we work (keeping it to subject info, verb info, object of the verb info was the best way to start). If I saw I was getting ahead of what Zachary could grasp, I simply had to slow down on the "full breakout" and work with the simpler "grouped" ideas graph (the first graph for each sentence). It really depended on Zachary as to how fast we would get to the "full breakout" and "full labeling" of articles (i.e., the), nouns (i.e., train), adjectives (i.e., long), verbs (i.e., pulled), adverbs (i.e., slowly), prepositions (i.e., into), and object of the verb (i.e., station... with associated adjectives, articles that go along with "station").

Now for sentence 3. This was, again, the same concept - just a little more complicated.

3a. The long steam train pulled slowly and carefully into the station and was loaded with logs, cars, truck and coal.

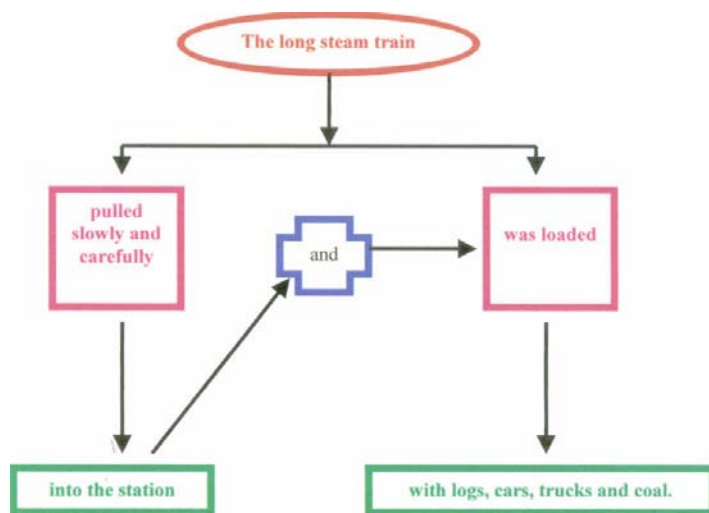

Note that no matter how difficult the sentence became, the "ideas" were grouped together, to facilitate comprehension and provide that "compartmentalization" of sentence parts I believed could help Zachary with actual conversation as it helped him understand the parts to the whole.

NOTE: As I did these examples on a chalkboard and worked with Zachary, I noticed he became confused with the sentence flow... that was easily fixed by a simple arrow change... now the arrow flowed exactly with the sentence... from "into the station" to "and". Zachary easily grasped the concept of bubble graphs. He was truly fascinated by it and enthusiastically answered with the correct answer when asked: "what goes in this bubble?"... so, I was sure this concept would work well for him! I had done this sentence with Zachary the day I first introduced the concept of bubble graphs to him. As usual, I always had a tendency to "get ahead of myself" when I saw how well Zachary grasped certain concepts. I literally had done all 6 of these bubble graphs with him in a matter of an hour or so. As with everything, the "complexity" of the sentence made no real difference because once the concept was learned, it could be applied to any sentence. I did encourage parents to start with simple sentences first, as I did however, to let the concept be understood in its easiest form first and to really work with "ideas" first as opposed to what was shown in part "b" of each example. I planned on "going back" a little to make sure Zachary truly understood the "subject" verses the "verb" info, etc., and I knew that right now, he did not have that understanding... although he certainly loved making these graphs. :o)

Zachary did have a fantastic memory though... a week later, Zachary was able to recall the entire last sentence from memory, in perfect order with no visual whatsoever! Truly impressive for a child who could barely recall a sentence when it was spoken to him in "conversation" right now... but, I knew this concept would ultimately help him with overall conversation issues! Thus, if I could teach him to do this for all sentences as he heard them, to automatically "compartmentalize them", I believed this would greatly help with his comprehension of language and his ability to actually hold a conversation and respond in "bigger sentences" than one or two word sentences as had been the case in the past. :o)

The idea for parents here was simply to experiment and do what worked best for your child. The above, 3a, was better for "idea comprehension" and "sentence" comprehension in terms of "flow" than was 2a ... and "idea comprehension" was the first objective! The exact label (see 2a for "proper" label of that arrow going to "and" as it had been taught to me as a child) could come later once Zachary understood the concept of sentence parts and what each represented. He had after all, just recently only had his 5<sup>th</sup> birthday – so I still had some time to get these concepts across. :o)

Finally, for the "full blown" labeling stage, sentence 3 would appear as shown below in 3b.

3. The long steam train pulled slowly and carefully into the station and was loaded with logs, cars, trucks and coal.

Note the changes I made to the flow here. This was slightly different from the way I was taught to break a sentence down into its parts, but, I believed this worked better for the autistic child... at least in the beginning. Actual proper labeling was not that big of an issue in that once the concept of "ideas being grouped" was understood (part "a" to examples 1, 2, and 3) it was much easier to "tag the label" to the idea. Autistic children strived on labels. Shifting the visual representation of "parts" in and of itself did not change the actual "label" of those parts, and hence "shifting them around", in my view, was not that big a deal. Once the concept and the labels were put together, it should be much easier to shift things as needed based on what seemed to work best for the child.

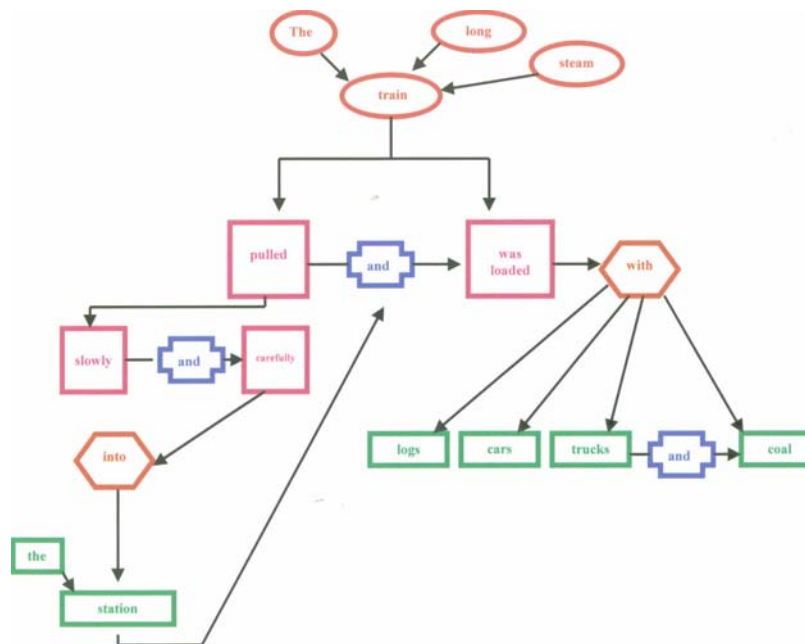

Again, note that I had switched the arrow between "into the station" and the word "and" leading to the next verb in order to facilitate Zachary's comprehension. When Zachary was ready for exact labeling, that arrow could be moved to its "proper spot" as in 2a... but, at this stage it was fine like this since it helped keep the ideas or "parts" together and helped with sentence flow, allowing Zachary to focus on the concept of "ideas" to language/ conversation. The shapes maintained the concept of "groups" of similar things (i.e., all red oval items referred to the subject, all blue square items referred to the verb, etc.).

Providing this consistency in labeling via the shapes and/or color would greatly help Zachary as he moved from "idea groups" to "labeling of words within an idea".

So, to recap, I would suggest doing "bubble graphs" with "ideas" lumped together first and ensuring that concept was well grasped (graphs 1a, 2a, and 3a type stuff) to help the child with "categorization" of sentence parts and ideas and then, later down the road, I would get into the full blown "labeling" (graphs 1b, 2b and 3b) of sentence parts as shown above. Note, there was nothing wrong with starting to label, subject items, verb items, etc., almost right away as long as the child was grasping the "categorization" of each group of "ideas" (i.e., the subject info, the verb info, etc.). Indeed, Zachary actually showed great interest when I actually "blew out" the bubbles for labeling purposes. The entire concept of bubble graphs fascinated him... understandably so... since before him were the keys to unlocking yet another code for language... sentence parts!

Once the "ideas" or "parts" were captured visually, the actual exact labeling of sentence parts could really take place, and in my opinion, truly move the child forward in mastering language and conversation.

As with everything, when the child was ready for the actual "labeling" of everything that "labeling" of specific sentence parts needed to take on a specific order to help the child see how the "parts" (word types, such as noun, adjective, verb, adverb, etc.) fit into the "whole" (the sentence). Each word type (i.e., noun, verb, etc.) needed to be specifically defined. For example, a noun was a person, place or thing.

Providing labels to sentence parts would further help Zachary grasp the concept of language. This was a good reference for teaching language basics.

<http://web2.uvcs.uvic.ca/elc/studyzone/grammar.htm>

The concept of bubble graphs as shown above could then be expanded specifically to teach grammar or actual word types such as nouns, verbs, adjectives, etc.

For example, for nouns, a bubble graph could be made to show "nouns" in the top bubble with that bubble having arrows to three separate bubbles below: persons, places or things. Each of those bubbles (persons, places, things) could then be made into bubbles of their own with examples of each below in yet more bubbles. For example, under a "top bubble" for "person", you could add arrows to a bubble below with the words: mother, father, sister, brother, doctor, teacher, Zachary, Andrew, Anika, etc. The same could be done with "places"... with words in

the lower bubble including things like: beach, park, home, school, Chicago, Arizona, work, etc. Likewise, the same concept can be used for "things".

The concept of the bubble graph was a very powerful tool for the autistic child in helping him to break the code to the meaning of sentences and "how they worked". If I found that Zachary was having too much trouble grasping idea groups, I would simply try to start by labeling the various word types and seeing if that worked better instead (i.e., making bubbles to define nouns, etc. as explained above).

For the absolute genius in labeling sentence types, this was a fun link that would surely keep any little genius from being bored!

<http://www.virtualsalt.com/rhetoric.htm>

Note that in labeling actual sentence word types, I had a specific order in mind.... first the noun... then anything related to the noun... like the adjective (big, fast, etc.) or the article (the, a, etc.). I would not move on to the next "type of word" (i.e., a verb), until all types of words relating specifically to the first type (the noun) had first been identified (i.e., the adjective, the article) and their association to the first type of word, the noun, carefully shown and defined.

Finally, the next step would be to take the same sentences you had previously used and to "move them around" to show how simply changing the order of the words could change sentence meaning as well. Again, I would use the bubble graphs to do this.

If you think of the "building blocks" approach... it was my belief that language should be taught as follows to the autistic child:

1. Start with the alphabet (using songs, colors, border type posters, etc.)
2. Show the child that letters had sounds.

Note that I did not say: Tell the child each letter had "a" sound. That would be incorrect since some letters had more than one sound. To say each letter had "a" sound would introduce confusion for the child when "another sound for that letter was taught"... and I believe that once "labeled" as "each letter had "a" sound", you would have a very difficult time undoing that label showing only "one sound association". That was why I felt my approach to phonics had worked so well with Zachary... I gave him all the sounds for each letter at once, simply using the word "sometimes" between the letter sounds! By introducing all the basic sounds for one letter all at once, I did not "surprise" Zachary by trying to introduce "additional sounds" for the same letter. So, the key was to say: "letters have sounds"...and to say that a letter can have 1, 2 or maybe even 3 or 4 sounds... and to simply join those sounds with the word "sometimes", as explained in my section on Phonics.

I would work on showing the child the sound(s) for each basic letter by saying them out loud... going through the entire alphabet each time. That provided continuity for the child. In addition, it was less stressful. To stop in the middle of the alphabet may prove stressful for a

child who could not cope with partiality, what I believed to be the root of almost all problems we saw in autistic children. With practice, the child would see the "label" to each letter and sound association, and as with everything, that "sound" would become an entity in and of itself and so, as time went on, it became easier to go through sounds "out of order" and to mix up the alphabet. From the time I started to teach Zachary sounds, to the time I could mix the letters up took only a matter of days.

3. The next step would be to show the child that you could put letters together, to make new sounds (digraphs) and that sounds could be put together to make words...and that WORDS provided LABELS for things!

4. Next, I would show the child that you could put letters/sounds together to make words. Once Zachary knew his letters and sounds, it was simple to "put them together" for him... to simply write a word and have him read it by saying: "What does that say"? or "Read that word" and putting my finger under each letter as I showed him to read the first few words. After just a few, he was off and running...

5. Next, I would provide a "visual" representation of the "parts" of the "whole"... the words that made up the sentence by use of what I called a "bubble graph" as shown in 1a, 2a and 3a.... and eventually moving on to 1b, 2b, and 3b after the child had grasped the concept shown in 1a, 2a and 3a.

6. Next, I believed would come the labeling of word types within a sentence... a noun, an adjective, a verb, and adverb and so on... in a very specific order, as noted above.

Order I would suggest: noun, article (i.e., the, a), adjective, verb, adverb, object of the verb or preposition (answers who, what, when, where, why, how), phrase (idea), preposition (with, under, into etc.), and conjunctions (i.e., and - words that join ideas or phrases). Show that ideas could be put together to make a sentence. Sentences should be labeled as complete thoughts. Sentences could be put together to make paragraphs. Paragraphs could put together to make a story, show a lesson, provide information or for pleasure/fun. Lessons had to be defined as teaching you facts, morals or could be just for "fun". Each one of these things would need to be labeled and defined as its own entity, with its purpose made as clear as possible for the child (i.e., the paragraph, the sentence, the lesson, etc.).

7. Next, I would change the order of the words in the sentence... the order of phrases within the sentence to show how changing order can change the meaning as well! :o)

8. The next step to actually getting to conversation was to help the child "visualize the bubbles" away from the paper/board - as conversation was taking place. This could be done using your finger and "drawing/placing/pointing to the bubbles in the air - as you spoke". This provided a visual reinforcement for the child that "conversation was simply sentences with parts"... and should help take the concept of "bubble graphs off the wall or chalkboard" to apply it to daily life!

9. The final step would be in helping the child focus on the "important parts" of the sentence... to explain that "when people talk, the important stuff was usually at the beginning or the end of a sentence" and that you had to "answer" the person. To answer, would mean to answer the question, or reply to the last part of the sentence. Role playing would greatly help in this area. For example, I often asked Zachary a question and then provided the answer to... and then, made him repeat it.

For example, if I asked Zachary: What are you doing? If he did not answer, I answered for him and told him: "say... I am watching tv mom"... and he usually then repeated the answer for me. Much as with echolalia and "ordering language", this helped him to "order" appropriate responses for future use - reference communication, as talked about earlier.

Zachary was just starting to initiate conversation... right now, he answered my questions. He was getting slowly better at using more words in his replies. I had also noticed that he was now using more "statements of fact" in his conversation as opposed to labels and commands. For example, he was finally saying: "I am tired" and expressing emotions or "how he felt" more. Since autistic children had such limited speech... and speech development was often so lengthy, it was easy to fall into the trap of "conversation" simply taking on the form of "questions" initiated by the parent/caretaker. Parents, like children, needed to work at increasing the variety in terms of the types of language used... to move away from "just questions" to "exclamations, statements of fact, etc." I, personally, found this hard to do after having spent so much time always "questioning" Zachary.

Although I, myself, was just really at this stage of moving from labels and commands to actual conversation with Zachary, I found that he was quite receptive if I did the following: When he asked for something, I took it the next step by asking him for the "object of the verb"... in other words, I always tried to ask him to answer the "who? what? when? where? why? or how?" behind everything he wanted. When he said something, no matter what it was, I tried to "tag on" one of these questions to expand on the idea.

A simple: "give me that" on his part was followed by a "what do you want that for" on my part. "I want juice, please" on his part was followed by a "where are you going to drink that juice?" on my part. It was easy enough to switch the "who?, what?, when? where? why? and how?" around to create a little variety in speech. For example, I could also respond: "how do you want your juice?" or with "when do you want some juice?". At this point, I pretty well always had to answer for Zachary, and make him repeat the "answer", but that was fine since I knew this helped build that "reference communication for him". Anything to help further the idea just one more step would eventually go a long, long way toward helping actually get to conversation. :o) Using this concept in reading books, and pointing out the "who? what? when? where? why? how?" as the book was read should also help a great deal in making this whole concept of phrases as ideas, or parts to a sentence a lot more concrete.

Obviously, since I was just starting to do this myself, Zachary still struggled very much with my doing this... so, I always helped him along by giving him the answer and having him repeat it. This did a couple of things. It helped reinforce the concept of "what is the object of the verb"... and therefore, this helped him "understand the ideas" or "parts" to the sentence and made my

paper examples of bubble graphs now become practical, concrete examples of speech that he could use for future reference. Once I could get Zachary to think this way, I believed conversation would flow much more readily and that comprehension would be greatly increased (although I did believe he truly understood a lot more than I gave him credit for :o) ).

The key to all language, however, in my opinion - was labeling and the definition of purpose for each type of word or phrase! The more parents labeled and explained, the more the child would understand - the more he would "break the code" and the greater his progress would be... in all areas!

**Given what I had come to understand, as provided further in this document, I also believed that motion was critical in terms of actually understanding language and the meaning of words. Thus, "moving bubble graphs" would be the best way to teach the "concepts" behind language (via software, videos, etc.).**

In terms of teaching language, there were a few other key areas that I also wanted to address in terms of "how" I would teach them based on what I had seen in Zachary.



## Teaching Synonyms, Antonyms, Homonyms, Homophones and Acronyms

### To The Autistic Child...

#### Synonyms and Antonyms

Much like the concept of "same" and "different", the same stumbling blocks were true in teaching the concept of "synonyms and antonyms".

I knew this had been another area of struggle for Zachary. I found that the key was in "which words" I used to teach this concept. Zachary understood the concept of "equal to", so, when teaching synonyms or antonyms, or the concept of "same" verses "different", the words "equal to" or "not equal to" went much further in getting the point across than saying for example, "means the same thing as". "Means the same thing as" had no meaning to Zachary... for him, all things were "this" or "that"... so, the difficulty was in breaking that understanding that something could only be "one thing"... that only "one word" could represent "one thing". The best way to do that was to use the words: "equal to" or "not equal to"... that made it clear and provided the "order" Zachary needed to understand the concept.

Once he learned what words could mean the same thing or could mean opposites, I could expand his vocabulary even further by using "equal" or "not equal". By the way, the concept of opposites worked well for Zachary... so, responding to "what is the opposite of ..." would not be difficult for Zachary. Again, however, it was an "all or nothing", up verses down, open verses closed... so to teach "more" antonyms, I believed there would be greater success in expanding vocabulary by perhaps switching between the use of "not equal to" and "opposite of".... in the same way that "equal" should be used along with labeling something as a "synonym". Proper labeling was critical! One or two word labels were best to teach concepts. As with everything, I found it critical to try to teach the "in between", the "parts" or "variations" to each concept... to use examples that showed degrees of "sameness" or of "difference".

[Words That Teach Quantity](#), thus, were another excellent tool (see section on Words That Teach Quantity).

**The key to teaching so many concepts, I found, was simply to use "equations" to teach variations of the same concept. This, I believed, was the critical key to overcoming issues with incomplete reference communication – especially as it related to issues of safety (see section on Safety).**

In teaching the concept of "same verses different"... I took pictures that looked alike, but not quite... showed gradual increases in "sameness" or in "difference"... changing "one thing at a time"... adding "one difference or sameness" at a time... and using the [Word To Teach Quantity](#) as I went along... saying for example: "This one is just a little bit different" and pointing out the difference on the picture. I labeled the difference for Zachary by verbally expressing the difference.... then, once Zachary had reached the exact same picture as the original picture, I would say: These are exactly the same... emphasizing the word, "exactly". Again, was all in teaching the "in between" and labeling the "in between" for the child!

## Homonyms

Homonyms were words that were spelled the same way but had different meanings. For example, a pool of water and the game of pool (played on a pool table). I had not had to do much with these yet, but I did anticipate that they would pose a problem. I was sure that the use of equations would help, but, again, using the same word to mean different things would undoubtedly cause issues for Zachary. This was simply not an issue I had really had to deal with so far. Perhaps in this case, pictures would be best used... with the words written below them. I had done many flash cards with Zachary. Perhaps the key here would be to teach these separately. For example, not to teach the 2 meanings for 1 word spelled the same way on the same day... but to actually space out the 2 definitions... providing one on one day, and perhaps the other a week or two later. I think time and pictures would be the best tools to use in teaching this concept that one word could mean many things.

For the autistic child, homonyms would definitely cause confusion if taught on the same day... because for the autistic, everything needed to "make sense" and have its own label... and here, the "one label" was used to mean more than one thing. Thus, the "parts" could be defined based on a specific label alone... and as such, I believed that with that label must come something else... perhaps "a picture", or some other association in order to help solidify the concept that one word could mean many things.

## Homophones

Homophones were words that sounded the same, but were spelled differently. An example of homophones was: to, too, two – or sun verses son. Here we had words that sounded the same, but that meant something different. With homophones, I thought that teaching these words on different days would again be key. Things that were “the same” (here the same in terms of sound) but that mean something different should not be taught “together”... I just thought that would introduce too much confusion for the autistic child, although, due to the different spelling, I believed teaching homophones would be easier than teaching homonyms.

I believed that once homophones were taught (preferably separately), that the autistic child’s accurate mind would simply memorize these as “different” words even though they sounded the same due simply to the fact that they were spelled differently. In this case, the parent’s tool of choice was again, definitely “time”... actually teaching these on different days. Again, the use of equations in the form of “two = 2” or “too = also” should help. Another example would be the use of son verses sun... again, the concept was the same, sun = something in the sky that was yellow, whereas son = mommy and daddy's boy.

## Acronyms

In working with Zachary, I also noticed that acronyms were a problem for him. For example, as he worked on the computer, I noticed that Zachary would always say: "hit oak" when he saw the word "OK" on any computer program. So, he could not read the letters to the acronym... he read the acronym as he would read any word... and with "ok"... that produced the sound of "oak".

I had only started to work this issue. In using bubble graphs as discussed in my language section, I once made use of the song Twinkle Twinkle Little Star as an object of the verb. Rather than writing out the entire title in the bubble graph, I simply wrote: "T.T.L.S." and pointed to each letter as I said the song title. Zachary had seen the title spelled out in the sentence and so it was easy enough for him to make the association. This was the only time I had ever really worked this issue with Zachary. I honestly did not think this concept would be that difficult a concept to teach as the use of equations (i.e., "equal to"), visual representations and actual verbalizations as to what the acronym meant, together, should greatly help the autistic child understand this concept. I found that in teaching acronyms that "periods" between the letters were better than just letters in terms of getting the point across.

Finally, in teaching Zachary anything, I found that some of the best coping tools I could provide were "[Words To Cope](#)" and "[Words That Teach Quantity](#)". Both of these greatly helped me to reduce Zachary's stress levels when things simply became too frustrating.

## Words To Cope©... Words Of Encouragement... Words To Help Understand...

In working with Zachary, I found specific words to be a great help for him. When frustrated, he came to use these himself to deal with frustration.

For example, if something was particularly frustrating, I would always say:

"it's ok...it's ok..." or "try again...", or "you can do it..." or "all done", etc. When things did not work exactly the way he wanted... for example, when a stack fell over, I would say: "it's broken" or "it's too tippy". To help him separate a part from the whole (for example - a band aid on the skin), I would say things like: "it's stuck". Again, that helped him cope with the fact that something that did not belong "was there" and that better helped him cope with the "partial" (i.e. the bandage) and helped him accept it as part of the whole... as something it was ok to have there. Using "all fixed" also helped in many, many situation. These were just simple examples of words I used that I found very helpful to Zachary... you could use them in many, many situations to help your child cope with the partial he had so much difficulty with. "Bye-bye" was another one... a word to help "complete a visit" for example... much like "all done". "All done", I found helped tremendously in going from one situation to another... helping with transitions... helping to see completion of one task and time for the next.

Words like: "it's stuck" or "it's broken" were especially important to Zachary. Given his inability to cope with partiality in anything until parts were labeled and made entities in and of themselves, I could certainly understand, why these two short phrases, in particular, were among Zachary's favorite in helping him cope with stressful situations. Things that to him did not appear to belong were just "stuck" or "broken", until they could be better explained and understood.

Also - again - helping him to "understand the problem" was a great help. For example, if Zachary wanted to stack a lot of big Legos and they tipped over, I would say: "make it sturdy" and show him how to do that as I reinforced the base of his stack and said, "see, now it's sturdy". Soon, as I kept saying "make it sturdy", the frustration pretty well went away and he could cope much more easily with the situation when the blocks tipped over.

So, the key was to provide "Words To Cope©" when frustration presented itself. Other words I used were: "it's ok to be different", or "it's ok to be silly", or "let's make it different", or "let's make a funny pile", etc., ...as I showed him how to make things different, or funny, or silly, etc.

Another key phrase I used was "try again". Zachary really caught on to that concept...whenever I gave him something he did not want to eat, now, he would say: "try again"... it was so funny! He did the same thing when I tried to engage him in activities he did not want to do, etc. I guess you could say that's his "favorite saying". When he could not do something on his own and needed my help, he caught on to the "you can do it" phrase I used with him... only now, he said: "you can do it, mom". :o)

I made all these simple words/phrases part of my daily vocabulary...they helped increase flexibility... and that was key! These concepts were concepts parents used everyday with their

children, to various degrees, and I suspected, this also helped explain why some children coped better than others... it was all in the labeling, the use of the "right words" and in explanations (i.e., of purpose, etc.). :o)

### Words That Teach Quantity...

Another great tool for teaching the autistic child!!!

I used many words to teach the concept of "the part" verses "the whole". The words below were but a few to get parents started on teaching quantities or "in between" situations. In addition, when teaching a specific thing, a specific concept, the "degrees" within that concept needed to be taught... the part verses the whole in everything. This was applicable for teaching in all areas of life for the autistic child. These words helped the child understand a multitude of concepts in terms of how the "parts" fit into the "whole".

a couple	each	how much	none	some
a few	empty	in between	not quite	somewhat
a piece of	enough	just about	one	sparse
all	equal to	less than	only	too little
all but	every	a little	part of	too much
all done	exactly	many	partial (ly)	totally
almost	few	much	plenty	various
any	full	multiple	Scarce	very little
as good as	group	nearly	Several	very much
as much as	how many	no	Sole	whole

## END OF LANGUAGE SECTION FROM BOOK 2

## Updates To Language Section Provided In Book 2

In going through this section, at least initially, I suggested readers “go back” to the three-page, basic, brain structure and function overview often to better understand the issues. See the Table of Contents for the page number and “keep a finger on those pages” as a place marker as you go through this section. For a person who had not read some of my previous works, this section could seem a little overwhelming if not read with the help of that basic overview. However, when the overview was kept as a “reference”, the issues, in my opinion, became clear rather quickly and were much, much more easily understood – especially when the University of Calgary video on neurodegeneration was also kept in mind – a video that clearly showed how mercury completely devastated neurons and shrank them to approximately half their original size. Again, this video, for those who had not viewed it, was available on my website and I encouraged all parents to view this information.

The video on neural degeneration could take quite some time to load, but I urged you to take the time to allow it to load. A picture in this case was worth more than a thousand words – truly, it would leave you speechless – and I suspected that this video showed exactly why, so many children with autism – indeed – now lived – speechless!

As I now looked back and tried to remember “what had worked” for Zachary in terms of language development, and looked at that from a brain structure and function perspective, there definitely were some things that had been absolutely key – things that were now so much better understood when looked at from this brain structure and function perspective.

I did want to remind readers that the first thing we had done was to place Zachary on a casein free, gluten free diet. For him, that had made a huge difference. I knew that for some parents, the change in their children did not appear “that great” when their children were placed on ckgf diets and as such, many appeared to give up after a few months. Given it took gluten close to ten or eleven months to leave the body, we had decided to stick with it, and I was glad we had. Indeed, it had taken close to a year for Zachary to finally put together two or more words. I now understood why that was (more on that later). Zachary was fantastic as “labeling things”, but, conversation, had simply not been there and that first year had seemed so, so difficult as a result of that. In looking at language development, however, there appeared to be no doubt that even though some children with autism were on ckgf diets and others were not, there were still certain “common themes” to language development for those children with autism who did develop language. Perhaps the most common of these “themes” was that behavior known as “echolalia” or the repeating of words said by someone else.

Echolalia was defined as follows - I quote:

***“ECHOLALIA is a meaningless, persistent, verbal repetition of words or sounds heard by the patient - often with a mocking, mumbling, staccato, or parrot-like tone. Echolalia is in response to the same stimulus, whereas perseveration is repeated responses to varied stimuli.”***  
***[end of quote, emphasis added, Jacob Driesen, Neuropsychology and Medical Psychology Resources, Glossary, [http://www.driesen.com/glossary\\_e-i.htm](http://www.driesen.com/glossary_e-i.htm)].***

Meaningless! Every time I read that word as it related to echolalia, I could not help but laugh. Perhaps “the experts” did not understand this parroting, but that, in my opinion, certainly did not mean this language was necessarily “meaningless chatter”.

Why was it that children with autism so clearly engaged in this “parroting” behavior when it came to language? They pretty well seemed to do this universally. Indeed, it seemed “rare” to find a child with autism that did not engage in this parroting form of language. That in and of itself told me there had to be “something” to echolalia – it had to serve some kind of “purpose” in these children.

For decades we had viewed this behavior as “dysfunctional”. Now, as I looked at this “parroting” from a brain structure and function perspective and thought about language development in Zachary - it made perfect sense! This form of language, in my opinion, was anything but “meaningless”.

Functions in the temporal lobe included, among others, the following: auditory processing, memory acquisition, understanding of language, voice and face recognition, categorization of objects, some visual perception, ability to distinguish between truth and a lie. All of these had implications in the behavior known as “echolalia”.

Of these functions, clearly the obvious one relating to language was that of “understanding of language”. But these “other functions” listed above, also very much played into language development – in not only a child with autism – but, in any child.

Let us remember my three major premises: 1) there appeared to exist little or no communication among the various parts of the brain in children with autism, 2) those functions co-located within a specific part of the brain (i.e., the temporal lobe) appeared to have “magnified communication” in children with autism, and 3) it appeared those functions that were co-located within a specific region could be much more inter-related than we could have ever imagined in the past.

If one considered issues relating to face recognition and the interaction of children with autism and their caregivers, the assumption of little or no communication among the various parts of the brain in these children would certainly help explain issues in “facial interactions”. Functions of “face recognition” resided in the temporal lobe. Yet, visual attention functions resided in the parietal lobe, and visual processing resided in the occipital lobe. As such, several parts of the brain were involved in the simple act of “face recognition and facial interaction”, and, needless to say, if those parts of the brain were not communicating properly, it would not be surprising that children with autism would have tremendous difficulty in this area.

What was known about these children, however, was that in looking at the face, they very much tended to focus on the mouth of the person speaking. Again, this was not surprising to me given that auditory processing and the understanding of speech were co-located in the temporal lobe along with face recognition. Thus, it made perfect sense that a child attempting to “break the code” to language would focus on the mouth of the person speaking. The same was also true of persons who were deaf and who learned to “lip read”. Their auditory processing was impaired,

and yet, they chose to try to decipher language in others by “lip reading” – again, focusing on the mouth! Auditory issues were clearly documented in children with autism and although, like Zachary, their hearing usually indicated they could hear, there certainly appeared to be certain frequencies that were more bothersome to these children.

As I discussed matters of “hearing” with a man who was losing his hearing, he commented to me that even with a hearing aid, he often could not hear what was being said by those next to him because of the “background noise”. “Background noise” had been the major issue in his hearing loss. Could it be that in children with autism, they too heard the “background noise” more? Could this possibly play into the fact that these children were so easily distracted and had an “attention deficit”? Perhaps. The more I looked to my son for answers to his autism, the more many other things made sense, too!

For example, in looking at echolalia specifically, clearly one needed to be able to “understand language” to communicate. But, how did one come to learn anything – be that language, a skill – or pretty well anything else? **Repetition!**

It was well documented scientifically that the solidification of “memories” was very much impacted by repetition. In other words, the more you practiced something, the more easily you could do it. The more you practiced or repeated in “language” matters, the more easily you could remember it (i.e., memorizing a poem, learning new words, a new language, etc.). Clearly, for example, the more often I used “a new word”, the more easily I remembered that new word and its meaning. What was “echolalia” if not “repetition of language” – repetition that in my opinion, was the child’s way of coming to understand and solidify language – both the words themselves and the “when to use this word”. In other words “echolalia” was nothing more than the building of “references” as they related to the development of language – and hence, the term “reference communication” to describe what I had so clearly come to understand Zachary’s early speech development.

Not surprisingly, Zachary no longer engaged in echolalia. Echolalia, in Zachary, had disappeared as his understanding of language had increased. Now, when he ever repeated a word, it was because it was “a new word” and that “repetition” was usually accompanied with “spell . . . ., mom” (with the “. . . .” being the new word). When I spoke, or anyone else spoke, if the words used were words Zachary already knew, he did not repeat them.

Obviously also involved in language development was the function of auditory processing – also located in the temporal lobe. Note that although certainly a “plus” to language development, a child could be deaf and still have an understanding of language. As such, although “desirable”, auditory processing certainly was not “a must” to the “understanding of language”. It was very interesting that although the “understanding of language” was located in the temporal lobe, the “production of language” was located in the frontal lobe – along with motion, smell and control of emotions – all functions I now believed to be much more inter-related than we could ever have imagined.

The sense of smell was discussed at length in both book two and book three and would be discussed somewhat later in this text. The point I wanted to make here, as smell related to



communication, however, was that clearly, smell did play a role in communication as well. This was clearly evident in the animal kingdom. Yet, a person could hold an orange in his hand, and have an understanding of what that was simply based on smell and/or touch. The sense of smell had functions located in both the frontal and temporal lobe – parts of the brain that clearly involved language functions also. Likewise, I could hear a bird’s song and know that this was “a bird” without having to do anything – myself.

Simply smelling something or hearing something provided “some form” of communication or **understanding** in and of itself. I think that society made a huge error in assuming that the lack of a response meant “no understanding” because, clearly, that was not the case. As I considered the fact that the “understanding of language” was in the temporal lobe and the “production of language” – for example, a verbal response – was in the frontal lobe, this only made even more sense in my opinion. Clearly, production and understanding were two very, very different things! I could simply smell or hear something and have a complete understanding of “what that was” without – myself – showing a response (i.e. verbalization) – and I suspected many children with autism understood much more than we could ever imagine, too!

Note also that to “produce language” did not require working eyes, ears or vocal cords – indeed, **language production and understanding** could be based completely on – **motions and/or touch**. I very much suspected that this was why sign language appeared to work for many children with autism who were non-verbal.

Zachary always loved learning anything that involved motion. I had only started to teach him some of the basics in sign language. He was always very, very excited to learn new words such as “stop” or “go” in sign language and then play with me as we applied those signs or motions during our playtime outside. I had started to use motions in working more with Zachary in the area of safety and crossing the street and had found that he understood concepts much better if I made use of motion such as sign language. This was all very, very new to me, and as such, I still had a great deal to learn in this area, but, I certainly could see the potential that existed in terms of communication with children with autism via the use of – motion! In my opinion, this was truly one of our most untapped tools yet, perhaps one of our most effective tools in communicating with children who have autism! Motions could certainly be used to teach many, many concepts. This was not to say that verbalizations were not also important – clearly they were - however, what I was saying was that motions were a valuable component that should be included with other methods in attempting to communicate with the child who had autism.

In my opinion, it was important to use as many forms of communication as possible. For example, if a child had shown any ability to verbalize sounds there was hope there. Granted, cerebellum damage could impact one’s physical ability to speak, yet, the cerebellum continued to develop until the age of twenty or so and as such that provided hope that perhaps, even in the case of cerebellum damage actually impacting the motor functions involved in speech (i.e., physical nerve or muscle damage), there could be the ability to later down the road come to overcome some of these limitations as well. If there was one thing I had come to understand in this journey with autism, it truly was that the human brain and body were amazing indeed in their ability to adapt to injury. Thus, if one approach did not work, perhaps another would.

As such, I would encourage as many different ways as possible in attempting to reach these children by using not only motions, but phonics, word associations, etc. to help these children break the code to communication. It could take a lot of work to get that “first crack” in the shell, but once that “first crack” came about, it certainly opened great doors of opportunity. Society had seemingly given up on so many of these children, yet, I knew that no matter how difficult things could be, past, present or future, I simply could never give up on Zachary. I knew there were still many challenges ahead, but, those would be things I simply had to deal with one day at a time.

As I had stated earlier in so much in the life of the child with autism, it appeared that stimulating as many parts of the brain at once was key to their understanding, and given that motion was a valuable tool for communication – one that already existed and was very well developed – in my opinion, this avenue was perhaps one of the main keys to unlocking the doors of communication with those children with autism who were still so completely in their own world. In my opinion, motions would in all likelihood help with the understanding of many concepts for these children – whether verbal or not.

One could be deaf, mute and blind and still learn to communicate. Motions did not have to be “seen” – they could also be “felt”. As such, making specific motions in the palm of one’s hand, for example, certainly was a way of establishing communication with a person who could not speak, hear or see. Everyone could pretty well “feel” something on the skin – and that “something” could certainly be “the feeling of communication motions”. Thus, clearly, motion and language production were absolutely tied to one another. If one could not “feel” something on the skin, if that person was also blind, deaf and mute, then, what “other options” were available for communication? I could think of none. As such in order to be able to “produce language”, you had to at least be able to “feel language or communication motions” on the skin.

Thus, in looking at language production it would be very, very difficult to obtain “language production” in a person who was blind, deaf, mute **and** who had no feeling whatsoever in the skin. But, I knew of no one that was “that impaired”. Note that a person could be paralyzed from the neck down and still be able to have “feeling” on the skin found in the area of the face. As such, it appeared almost impossible to be completely without the ability to “feel something” via the skin. And, as such, the skin, and the sense of touch was absolutely key to language production in persons with impairments in sight, sound processing, and/or speech. The one thing that appeared to be “unfailing” when it came to the ability to produce language was the ability to “feel language”.

As such, in persons with all kinds of disabilities as they related to communication, one of the critical keys was motion – and hence – sign language! It was because of this that I now felt sign language should be taught to all children in school because, if someone became disabled later in life in a manner that impacted actual speech vocalizations, sight, or sound production, one thing that a person could fall back on was the ability to at least be able to “feel or see the motions of language”.

As stated in my second book, this was also seemed to provide the reason so many of us instinctively “used our hands” and “motions” when we talked.

Although motions were very, very, important, it was also necessary to keep in mind that, in a child with some verbal ability, perhaps they should be varied somewhat. The reason I stated this was because if a child had any verbal ability that meant there was hope in helping that child to actually talk. Yes, sign language should be used, but when dealing with children who had the ability to speak somewhat, although *motion*, it appeared could be key to *language production and word associations* (all in the frontal lobe), the *understanding of language* appeared to be tied more to *auditory processing* since both those functions were co-located in the temporal lobe.

***Thus again, would it not make sense that functions that were closely linked – physically – in the brain, were probably located “together” because they impacted one another more than did functions located in other parts of the brain. It just seemed to make sense to me that neurons most closely tied together would most “interact” together.***

With Zachary, I had always done things like “acting out letters” with my body parts as I called them out. I had worked on teaching him to understand the alphabet in many different ways – the computer, singing and acting our songs, puzzles, and body part motions. There were also good suggestions in The Phonics Handbook by Sue Lloyd that could be used to teach the alphabet and associated phonics.

My concern with using “just constant or repetitive motions” was that if a child had the ability to speak and yet motions were better understood, I wondered if a child would come to prefer to simply “use motions” and use speech less – even if the ability for speech was there. I did not know. In my opinion, it was important to teach the same thing – the same concept (i.e., the alphabet) - in many ways to show the child that *“the concept”* was key – not the motion or method. In so much, for Zachary I soon saw it was *“teaching of the concept”* by using co-located functions that was key - to breaking the code!

In trying to get actual language production - actual verbalizations – in children with autism – especially children who had shown the ability to utter - “something” – I truly felt “multiple ways” had to be used. ***The idea was to show the child that the “constant” was “the concept” (i.e., the alphabet or the letter-sound association, etc.) as opposed to the motion itself for example. Motion was critical – of that, I had no doubt – but I also recognized the need to help move these children toward actual verbalizations if possible also. Sign language could be a powerful means of communication when no other communication was possible, but if other means of communication were possible one had to maintain hope of developing those capabilities also in these children.***

Although language production seemed very much related to motions – both functions in the frontal lobe - the understanding of language was located not in the frontal lobe with language production, but rather in the temporal lobe with other functions. When one really started to look at those functions co-located in the temporal lobe along with the understanding of language, clearly, many, many of these functions appeared to be so very inter-related.

With Zachary, tools I had used (like the video I came to call “the alphabet train” video – a video that was actually entitled *The Miracle of Mozart ABC*” by Babyscapes, and available at

<http://www.babyscapes.com/ourvideos.html>), had made use of both sound and motion – and specifically of sounds that provided for “letter/sound associations” – something that surely could “tap into” functions of “word associations” that were co-located along with language production in the temporal lobe. Note that auditory processing, the understanding of speech and categorization functions were co-located in the temporal lobe and as such, this video also very much “tapped into” those functions as well. Also note that “word associations” (frontal lobe) were nothing more than “very specific categorizations” (temporal lobe function) and as such, word associations, provided, in my opinion, the critical key to bridging the frontal and temporal lobe functions – the critical key to bridging language production (frontal lobe) and the understanding of language (temporal lobe).

Language production (frontal lobe) clearly could occur “without making sense” to someone else. For example, I could speak or babble and not have anyone around understand me. A person could produce vocalizations that made absolutely no sense to anyone else. A newborn child could “babble” without having a clear understanding of language. Thus, language ***production***, in and of itself could in my opinion, occur without an ***understanding*** of language. As I thought about Zachary’s language development, I realized that the key was that, too often, we interpreted things like echolalia as “meaningless language”, but perhaps, it was only meaningless to the person listening and that it was actually “just a step” in the acquisition of language skills. The goal was to move from “just production” of language to an understanding of language in the sense that “others” – not just the child – could understand it also. Although Zachary had been unable to actually “produce language” for quite some time, I suspected he had been able to “understand” a great deal of it for quite some time also prior to actually “producing it”.

Understanding what was important to the ***understanding*** of language and how that understanding was acquired appeared to be very key.

Again, I could not help but think that co-located functions had to be “more inter-related” with one another than perhaps we had ever imagined – and that meant that if this were true, those functions key to ***understanding*** language had to be co-located with “understanding of language” functions – and that meant – ***“other” temporal lobe functions simply had to be key to understanding language.*** Likewise, ***“other frontal lobe functions”*** had to somehow be key to the ***production*** of language. And, the challenge – and indeed, perhaps the answer to issues of speech in children with autism - came in “bridging the two” via “similar functions” such as “word associations” (frontal lobe) and “categorizations (temporal lobe) that could act as key link to help rebuild connections that, in my opinion, very much appeared to have been severed.

The understanding of language was a temporal lobe function, co-located with ***memory*** functions and ***auditory processing***. But, the understanding of language was also co-located with other functions in the temporal lobe – and in looking at those functions it truly appeared to me that almost all functions in the temporal lobe had something to do with the ***understanding*** of language.

For example, the temporal lobe also included functions involving ***emotions***. Clearly, emotions were tied to the understanding of language. As described in book two, often, a person that experienced great sadness or trauma often appeared as though they lost the ability to understand

what someone was trying to tell them. It was often as though “they were failing to hear – failing to understand” what was said. Likewise, a person experiencing great fear or stress often failed to understand language as the “emotion” took over. There was no doubt that often it was very, very difficult to “reach” someone who was in a heightened state of emotion – as such, it was difficult to “make them understand”. Note that “control of emotions”, however, was not located in the temporal lobe – but in the frontal lobe – along with actual language production.

Note that emotion functions were located in several parts of the brain - the temporal lobe and amygdale (part of limbic system) as well as in the frontal lobe (control of emotions). Of these, key in the understanding of language was the ability to perceive emotions in others – a function that resided in the amygdale. The amygdale was known to synapse directly with the frontal lobe (where resided “language production” functions). There was no doubt that the ability to perceive emotion in others was also key in the understanding of language – a temporal lobe function. If this part of the brain - the amygdale - was not communicating properly with other functions relating to the understanding of language (temporal lobe), and/or production of language (frontal lobe), clearly, the understanding of language and/or the production of language would be somewhat impaired.

Perceiving emotion in others could involve both sight and/or sound (i.e., tone of voice). Note that voice recognition was co-located in the temporal lobe along with the understanding of language. As such, this very much explained why Zachary always understood emotions better when they were specifically verbalized to him. Yet, his visual understanding of emotions and how those played into the understanding of language was clearly impacted.

For example, on many an occasion, I had cried with Zachary in the same room. In fact, I could be sitting right next to Zachary and crying my eyes out and he simply paid no attention to me whatsoever. Yet, if I verbally said: “I’m a sad mom”, that immediately grabbed his attention and he always felt upset when I told him – verbally – that I was upset. As such, if I said “I’m a sad mom” and I was across the room from him, he would rush over and attempt to comfort me. Yet, if I failed to verbalize my emotions for him, it was as though he simply did not “see them” or “understand them”.

The same situation existed if I said: “I’m a mad mom”. Zachary knew that he was not supposed to do something that would result in a “mad mom” and as such, often, to get him to listen, all I had to do was say “if you do that, I’m going to be a mad mom... if you want a happy mom, you have to...”. Thus, when it came to the understanding of language and perception of emotions in others, clearly, verbal cues were much more powerful to the understanding of language than visual cues.

Likewise, I had stated in my second book, that when Zachary was shown a picture of himself when he had a horrible rash, he had failed to recognize that it was him in the picture. To Zachary, this could have been any child. Yet, when – told – that “this was Zachary”, he experienced tremendous distress. When – told – this was “him”, he – understood – it was “him” and it had been as though that had triggered a memory recall of the experience itself – and as such, his reaction to the picture was amazing in that it appeared to be worse than having gone

through the experience itself. Yet, had he not been – told verbally – that his was “him”, there would have been no reaction to that picture.

Thus, clearly, the understanding of language was tied emotions and memories and was very much dependent on auditory processing.

I was happy to say that since I had worked on issues of emotion with Zachary, he had made tremendous progress in this area as well. Now, just a “sad face” was usually well perceived – as were many “other faces”.

Recently, as Zachary read a book we both truly enjoyed, I had noticed something rather interesting. Zachary was now beginning to have much more expression as he read. This particular book was a favorite for both of us – The Giving Tree by Shel Silverstein (ISBN 0-06-025665-6). Although we both loved this particular book, we did not read it that often only because I always wanted to provide variety for Zachary. I never wanted reading to become “just memory recall” as it apparently was in so many children with autism – children who had a fantastic ability to remember entire books word for word. I had many, many books for children – literally bins full – and as such, providing variety for Zachary when it came to reading materials was not a problem. Yet, every once in a while, we would pull out “an old favorite” - The Giving Tree.

As I listened to Zachary reading the story to me, there were times when his voice had that monotone sound – that flat, no expression to it tone that almost all children with autism seemed to have. Yet, at other points in the story, Zachary truly showed proper intonation as he did the proper voice fluctuations in reading say, a question, in the text. He also showed emotion in his reading in parts of the story. It occurred to me that as Zachary was exposed to the story on several occasions, he had to now have a much better understanding of things like the “emotion” in this story and as such, I felt this was why he could now express that emotion in his reading of the text. Note that he also had a better understanding of words that introduced “a question” and as such, his intonation certainly had to be impacted as he now recognized more “question words”. Note that memory and emotion functions were co-located in the temporal lobe along with the understanding of language.

As I thought about Zachary’s reading of this text, clearly, again, so much could be explained by my theory of little or no communication among the various parts of the brain in children with autism. So many of these children were known to have the ability to read something – language production (frontal lobe) – and yet, could have no understanding (temporal lobe) of what they were reading. As such, language production (frontal lobe) could be there without the understanding of language (temporal lobe). Likewise, a person could understand language (temporal lobe) and not be able to verbally express that understanding via actual language production (frontal lobe). Also, language production and emotions were found in separate parts of the brain and as such, certainly, this had to play into the issues of proper tone or flat tone in what we saw in these children. Production of language – the actual verbalization of words – was located in the frontal lobe, yet emotions were found in the temporal lobe/amygdale parts of the brain. As such, again, if these areas were not communicating properly, certainly, this had to have implications for the expression of emotions in speech production. I also suspected

Zachary's love of onomatopoeias was due to the fact that these words were usually spoken with a great deal of expression and/or emotion. Words like "crack" or "squish" or "brrrrr".

Also, goal directed movement, visual attention, the sense of touch and manipulation of objects were co-located in the parietal lobe. Note that I did not have to hear, smell or taste to be able to read. Many of the primary functions needed for reading appeared to be located in the parietal lobe including the ability to integrate sensory input into a single concept. Indeed, reading difficulty was a sign of parietal lobe damage. The inability to recognize words and symbols was a sign of occipital lobe damage. The occipital lobe was associated with visual processing. Clearly, visual processing was an important contributor to the proper understanding of the written word, but it certainly appeared that the function of reading – in and of itself – "reading production" – appeared to be a function not of the occipital lobe, but of the parietal lobe. I could "read" without sight, for example, by using Braille – a "reading" system based on touch. Of course I was not saying that sight was not important to reading – clearly it was – but, it was not "absolutely critical" – I could still read, without sight if I made use of the sense of touch!

Thus, much as the production and understanding of language were found in separate parts of the brain, the frontal and temporal lobes, respectively, so too, did it appear that the "**production of reading**" and "**understanding of reading**" could, perhaps, be found in different parts of the brain, the parietal and occipital lobes, respectively.

If this were true, it appeared that to get "production" or actual "reading" to occur in a verbal child (one who could speak), one had to focus on those functions located in the parietal lobe. Yet, to have that "**understanding of what was read (not spoken)**", it appeared the functions in the occipital lobe (i.e., identification of color, locating objects in one's environment, ability to recognize words/symbols, etc.), were more important.

Parents of children with autism often clearly indicated that their children often had the ability to read (**production of reading**) but failed to understand what they read (**understanding of reading**). Perhaps we now had a better understanding of why that was when we considered that language was nothing more than "symbols" that had to be understood... and to understand symbols – or written language – it had to be categorized – and categorization of language symbols resided not in the parietal or occipital lobe – but in the temporal lobe. As such, clearly, all lobes, frontal, temporal, parietal and occipital had to be properly communicating in order to achieve both the production and comprehension of language. Indeed, if connections had been severed, in my opinion, the way to "rebuild them" had to be in finding "bridging" or "similar" functions across each area involved in speech.

As I completed this text, an interesting study had just been done in England. It appeared that – at least in the English language – as long as the first and last letter to a word were in the correct place, that the brain could "fill in" the other letters and still understand "the writing" – or the written word.

This was indeed all very interesting, especially since I knew that children with autism also often had dyslexia (i.e., making a "b" instead of a "d") and that the ability to distinguish between left or right was also a parietal lobe function.

Note that damage to the parietal lobe resulted in reading difficulty and the inability to differentiate properly between left and right. Yet, the inability to recognize words or symbols was a sign of damage to the occipital lobe – responsible for visual processing.

I had heard of this study on a message discussion board, and no one seemed to have the link to the original study. However, the study apparently had shown that it did not matter whether or not the letters in a word were in the right place, as long as the first and last letters were in the correct location, the brain could still make out the text and a person could still “read” because humans apparently did not see words as “individual parts” but rather, saw words as “wholes”.

Given everything I had come to understand in Zachary in terms of his need to understand “the parts” before the “whole” made sense, needless to say, I found this very, very interesting indeed. I knew Zachary to be an excellent reader, and that meant he had to have the ability to see “wholes” according to this study. Did this imply that reading was a right brain activity because the right brain processed “wholes” as opposed to “parts”? If that was the case, that implied that Zachary’s “reading functions” had not been impaired.

Alright... that was as much as I could type to give you an idea as to what this study was saying... especially given that word processing packages automatically corrected errors... it had taken me a long time to type just that one little paragraph. :o)

Again, this was all very, very interesting. A sign of occipital lobe damage – responsible for visual processing - was the inability to recognize symbols or words. Clearly, Zachary could recognize words and read very well. But, did that mean that “he” was reading the way a normal person did – apparently, seeing words as “wholes” or was he taking “the parts” to come up with the wholes? The reason I asked this was because although I knew Zachary to be an excellent reader for his age, another sign of occipital lobe damage was difficulty in drawing, etc., and clearly, with signs of dyslexia showing up in my son’s writing, that could indicate “issues with drawing”.

Of course, issues with drawing were also a sign of parietal lobe damage as was difficulty with eye hand coordination, difficulty with reading and difficulty in determining “left from right”. Interestingly, Zachary had no problem with differentiating “left from right” in “other things” – things that did not involve writing.

Zachary could easily read or recognize words and yet, when it came time to write his letters, clearly, there was some dyslexia there. Issues with eye/hand coordination and left/right distinction, both signs of parietal lobe damage, certainly appeared to be at play in dyslexia... but were they? If life was not already complicated enough at times, now I had this additional, yet very intriguing, puzzle before me as well.

As I considered “the written word” that was read – clearly, Zachary’s reading – especially for his age – was excellent. Right vs left did not seem to matter much – if indeed that was a problem for him. But yet, when it came to actually writing something – a motor function – then, the “left vs right” was absolutely an issue. That was all very interesting to me given it seemed “written



language production” – writing itself – was very much a function that required input from the frontal lobe (the motor cortex). As such, Zachary could easily read (written language production), but could not easily “produce” language from a motor perspective. Note that language “production” (what I had simply thought was verbal language production) was a function of the frontal lobe – but, now, I wondered if this “language production” was not also “language production” for the written word also.

Thus, there were many, many aspects to “language production”. It could be verbal language production (frontal lobe) or the production of language having to do with the written word – reading (parietal and occipital lobes) or it could be “language production” in the sense of writing itself (a function that clearly involved the motor cortex - also located in the frontal lobe). Note that when it came to “reading” – I could read without sight (using touch as in Braille) but I could also read without actually verbalizing something – without actual speech production (frontal lobe) and hence simply “read quietly”.

“Reading” could be viewed as a different type of “language production” – a very specialized form of language production and language comprehension that involved the written word as opposed to the verbal word! And, just as areas for verbal language production (frontal lobe) and comprehension (temporal lobe) had to be properly communicating, so too did written language production or reading (parietal lobe) areas of the brain and written language comprehension (occipital lobe) areas need to be properly communicating as well! This could certainly all get rather confusing – but it certainly was all very interesting also. Clearly, language and/or communication in humans involved several major parts of the brain and it could get rather complicated – rather fast. For language and/or communication to occur, these various parts had to have the ability to properly communicate with one another – something that clearly was not happening in many children with autism.

Yet, as confusing as all this could be, the one thing I now absolutely saw without a doubt was that most critical of all had to be the ability to properly – categorize language – whether written or verbal!

A person had to be able to “categorize” what he said, what he understood in terms of spoken language, what he read out loud (production of written language) and what he understood in terms of “written language” (reading quietly). To make sense of anything in life – it had to be - categorized!

Thus, in teaching a child with autism, in my opinion, one had to first determine whether or not the issue was one of verbal communication or written communication and then look at functions co-located with each of these in order to work on the desired behavior or function. Thus for ***verbal*** language functions, I believed one had to make use of bridging functions between the frontal and temporal lobes whereas in ***written*** language functions, one had to perhaps focus more on bridging the occipital and parietal lobes when it came to actually reading a text but on bridging parietal (eye/hand coordination) and frontal lobe (motor) functions when it came to actually producing written words (writing). Clearly, “to write” did not necessitate I need to understand “what was being written” and as such, it was not, in my opinion, the occipital lobe

that was key to overcoming “issues with writing” but rather the bridging of the frontal and parietal lobe functions.

To understand both the written and verbal communication, it appeared required the bridging of the temporal and occipital lobe functions. Given that “vision” bridge available to join temporal and occipital lobe functions and that the only functions relating to vision in the temporal lobe had to do with “face, place and body part recognition”, I was now beginning to understand why teaching language by using “body parts” had worked so well for my nephew Andrew and why children with autism so often focused on – the mouth – as opposed to the eyes. The eyes could provide very little in terms of “breaking the code to language”, but the mouth – now that was something worth investigating for a child attempting to break the code to language!

Again, this certainly could help explain why these children were often such excellent readers and yet had difficulty in other areas of “communication” and why they so very much, focused on – the mouth of others - as opposed to the eyes! The mouth in and of itself provided many insights into language for these children. Of that, I had no doubt. The eyes, although they provided some “non-verbal communication” also required bridging over to the amygdale – yet another part of the brain. As such, it seemed the eyes – for these children – were less important in “breaking the code”.

When it came to difficulty in understanding language, perhaps we needed to keep in mind that a “question” posed to a child verbally would involve the understanding of verbal language as opposed to the understanding of written language. It certainly would be interesting to study how well children with autism understood the written verses the spoken word and how using methods providing for the “categorization” of language could help with these issues given such methods could provide a variety of options to help activate as many parts of the brain as possible [more on language categorization later in this text].

Also, I had noticed that if Zachary hesitated in any way or if his attention was diverted, all I had to do was spell the first word in the next sentence or say it, and he would then keep going. This was very much parallel to the fact that hand over hand techniques also worked well with these children. In hand over hand techniques, all one had to do was do the first motion and usually, the child could go on to complete the motor task required. Note that motor functions and memory relating to motor functions were co-located in the frontal lobe along with speech production. As such, it made perfect sense that methods that paralleled hand over hand techniques in the area of speech production would work very much in the same way as they did with motor activities or in functions such as “reading”.

In looking at “reading” I now understood why this task came rather easily to children with autism – clearly it involved many, many aspects of the brain and as such, reading had to be an area or function that could more easily be “decoded” by the child than were perhaps other functions. The more tools one had available for “decoding”, the more likely the probability of success.

The other thing I had come to understand was that Zachary showed great enthusiasm in reading specific types of words – words like “CRACK!” or “vvvvrrrrroooooooooommmmm” or “buzz” –

words that sounded very much like the actual sound – something known as onomatopoeia – where the words seemed to imitate the actual sounds associated with the objects or action they refer to. Zachary absolutely loved reading and/or hearing words like these. As I thought about that, this too appeared to now make sense given that auditory processing and the understanding of language were co-located in the temporal lobe. What words would be best understood (temporal lobe function) if not words that sounded (temporal lobe) just like the actual thing (memory also in temporal lobe)? These words also very much activated the frontal lobe given that the language production in the vocalization of these types of words in particular provided a very powerful word association – an association that appeared to bridge the frontal (word associations) and temporal lobes (auditory processing, etc.).

But, there were other things Zachary clearly also loved to read... anything having to do with color for example, or the repetition of words like: “up, up, up” or “down, down, down”... or the reading of opposites. Small phrases like this involved repetition but also could easily trigger one’s imagination in that it was very easy to picture these things. Production of language (actual verbalization of these small phrases), imagination and word associations (i.e., opposites) were co-located in the frontal lobe and as such, I was not surprised that Zachary loved to verbalize such words.

Given my concerns over “pretending” – as clearly expressed in both books two and three, I was always certain to make sure that I explained to Zachary the difference between real and pretend in anything involving “imagination”. For persons who had not read books two and/or three, my concern here was that imagination and the concept of self were co-located in the frontal lobe yet the ability to distinguish between truth and a lie was located in the temporal lobe. As such, if the two were not communicating properly we had the makings of a very nasty situation indeed – a situation whereby a child could literally lose his sense of reality as he engaged in imaginary play. Yet, although I had major concerns with this issue of imagination and the concept of self, there was no denying that in the simple act of reading books a great deal could be learned in order to help these children.

Repetition was involved in memory (temporal lobe) formation and memory formation in the understanding of language (also in the temporal lobe) and as such, small phrases such as these – “up, up, up”, or “down, down, down” - appeared to also activate both the frontal and temporal lobe at once.

All this certainly had huge implications in terms of the types of books we should be using to teach these children – the types of books that could perhaps best maintain their interest.

All of these things, undeniably, were very, very interrelated and very much tied to not only the understanding of language, but to the actual production of language as well, as clearly, there were “some things” – key words, key phrases, key associations – that simply produced a much greater reaction and interest when it came to actually producing language in Zachary.

Likewise, I had no doubt that emotion itself (temporal lobe) and emotion perception (amygdale) and control (frontal lobe) – or the lack thereof – also played a role in language production and

understanding. These would be discussed in greater detail later in this text in a section dealing specifically with emotion in communication.

Also co-located in the temporal lobe with the understanding of language was voice recognition. Whose voice did one not recognize most if not – my own. As such, again, “parroting” or echolalia in children with autism, again, seemed to make sense when looked at in terms of the understanding of language and the theory that co-located functions could be much more inter-related than we may have ever imagined. Likewise, a child understood and responded most to the voice of a parent. Something said in the same way, to many persons at once, could often mean different things to different persons, yet, persons who knew each other usually understood exactly what one was saying when to someone else, someone less familiar with the speaker, there would appear to be “more confusion” as to the understanding of what was being said in spite of the “same tone” having been heard by all. Clearly, very subtle differences in tone could often also make a huge difference in what was being said or implied.

The function of face recognition was also co-located in the temporal lobe with the function of the understanding of language. There was no doubt that “those we knew” and “recognized” were those we best understood. Indeed, persons who knew each other well could very much communicate with facial expressions or “certain looks” only. Husbands and wives could “understand” what the other was “thinking” before any communication seemed to even exist. I knew that with my own husband, there had been countless times when we had been thinking about the very same thing at the very same time. Yet, it was always harder to understand “a stranger” and know what “they were thinking”. One certainly could have either an accurate understanding of another person based on “first impressions” but one could also be very, very wrong also. Thus, again, there could be no denying that both voice and face recognition clearly played a role in the understanding of language.

Closely tied to face recognition was the function of visual perception that also existed in the temporal lobe. Note that, interestingly, most visual functions were located in the occipital lobe. Indeed, the occipital lobe had functions that appeared to be related solely to sight. The frontal lobe appeared to have no visual functions at all. That was indeed very interesting given this was where “language production” was found. And hence, again, this certainly showed that language production was not dependent on “vision” and yet, in trying to produce language in children with autism, we often used visual cues. Perhaps this was one of the reasons so many were still “non-verbal”.

Also interesting was that visual attention was found not in the occipital lobe with other critical vision functions, but in the parietal lobe with somatosensory (body sensations) processing, spatial processing, touch perception, manipulation of objects, goal directed movement, 3 dimension identification and what appeared to be a very key function - the integration of sensory information that allowed for the understanding of a single concept – in other words – the integration of the “parts” into the “whole” – what I saw as one of the major issues in children with autism.

Although most of the visual functions in humans were in the occipital lobe, clearly, certain visual functions were located outside of this region. As such, I could not help but ask why that was.

In my opinion, the visual perception in the temporal lobe, a visual function co-located with the understanding of language, had to be related to other functions in that area – and that very much included the understanding of language. **Note that visual perception in the temporal lobe was associated with the recognition of faces, places and body parts.** As such, again, I truly felt that visual perception in the temporal lobe was somehow very much related to the understanding of language and that in trying to have children with autism understand language, those “visual cues” had to involve, in my opinion, face, place and body part recognition “visual cues”. In other words, using body parts to help with the understanding of language. Looking back, that had been exactly what I had done with Zachary in labeling so much for him... I had used my hands to physically touch everything as I showed it to him... and I had used his hands to make him touch everything also. I had used my body to “form letter” (best I could :o) ). So much I had done had involved – my body – just as had the phonics program my sister-in-law had used to teach her son – phonics!

In my opinion, this involved more than just “recognizing a person” when it came to the understanding of language. There was no doubt that a child best recognized and understood his parent. Yet, the child with autism had also revealed something else that appeared to be very key. In matters relating to communication the child with autism focused not on the eyes of another person, but rather on – the mouth!

The deaf often quickly learned to “**lip read**” in order to communicate. How very interesting indeed that, children with autism focused not on the eyes of a person, but on the mouth! In my opinion, this again, was an attempt to “break the code” to communication.

Again, this seemed to indicate that motion and voice recognition was key to communication. Note that “voice recognition” could take on a couple of forms. Voice recognition functions definitely involved recognizing a “familiar person”, but they also appeared to involve recognizing “familiar sounds”. Again, auditory processing was also co-located in the temporal lobe with the understanding of language. **Clearly, sounds (or lip motions involving face recognition and visual perception also in the temporal lobe) had to be recognized to be used in helping with the function of the understanding of language.** Sounds that were not recognized were simply not understood and recognition required **repetition and categorization for the understanding of language to occur.** As such, again, in echolalia, it was my belief that what we were seeing was the repetition and categorization functions so necessary to the understanding of language – the repetition of sounds (auditory processing) from familiar faces and voices – all temporal lobe functions!

Clearly, a normal child in language development repeated words spoken to him by his/her mother. Repetition helped solidify memory in almost everything and as such, it made perfect sense that children with autism would repeat everything they heard at first – much as would any child going through the normal steps of language development. In my opinion, what we were seeing in “echolalia”, as such, was much more than simply “parroting”. This simple act of repeating what was heard clearly activated almost the entire temporal lobe. Echolalia was the building of references for future use and a critical language development step that - because it occurred in “older children” - had simply not been recognized for what it truly was in children with autism.

Also co-located with the understanding of language in the temporal lobe was the categorization of objects. Of all the functions in the temporal lobe, perhaps the most critical of all for children with autism was that of – **categorization** – for within “categorization” was the ability to “order one’s world” - to make sense of it – to “break the code” – to almost everything in life!

Although at first glance it appeared that this was a function relating to concrete objects, clearly, the categorization of objects was absolutely key in the understanding of language also. To make sense and be understood, words were “things” that also had to be categorized. The word “sad” meant something very different than the word “jump”. As such, in order for language to be understood, it required not only that I be able to categorize it but that the person communicating with me also have this ability. For the child with autism it was critical to help with “categorization functions” as they related to language as this would certainly help with the greater understanding of language in these children.

As such, when I presented Zachary with a new word, I now usually always helped him to categorize it by providing for him things like the spelling of that word and a definition of that word. Examples of “how to use the word”, were also critical!

Note also that the processing of music was also located in the temporal lobe. Many studies had now indicated that music therapy was helpful for those with autism, Alzheimer’s and schizophrenia. Zachary always loved to be sung to. Indeed, if my theory of heightened communication and inter-relationship among the various functions co-located in a specific part of the brain were correct this indeed, would argue that music was also somehow tied to the understanding of language. From the time both my children were very small, I had always played classical music for them as they went to sleep – calming music, such as that of Mozart.

Mozart had composed music from as early as five years of age and his music, unlike perhaps other forms of music, was believed to help in activating neurons that stimulated very specific pathways in the brain that helped increase receptivity and retention in learning. The “Miracle of Mozart” video series by Babyscapes, Inc. were produced based on these studies ([www.babyscapes.com](http://www.babyscapes.com), 8391 Beverly Blvd, #276, Los Angeles, CA 90048, USA, 888-441-5437). Babyscapes, Inc. had produced that Miracle of Mozart ABCs video – “the alphabet train video” – Zachary still loved to this day!

Music had indeed always been important in Zachary’s life.

A song was a grouping of words and/or notes. It had a beginning and an end and usually, some kind of “pattern”. The word of a song was always followed by a specific word – in other words, the song stayed the same – its words did not change over time. As such, a song could easily be memorized and recalled. These factors helped explain why children with autism, such as Zachary, loved **songs**. They were “**language**” that was “**already categorized**” and did not change. This also explained why my son used to scream if the radio or CD in the car was turned off in the middle of a song. Children with autism seemed to always need that “all or nothing” and had no room for the “in between” in anything, and herein was the key to so many issues I had seen in my son.

***Note that loss of flexibility in thought was a sign of frontal lobe damage.*** The frontal lobe was associated with motor functions (perhaps explaining also loss of flexibility in motor functions, ie., obsessive-compulsive behavior and repetitive behavior), the production of language (perhaps explaining loss of flexibility in speech and the need for “sameness” in speech production), olfactory functions (perhaps helping to somewhat explain lack of flexibility in food choices), control of emotions (perhaps explaining lack of flexibility in emotional responses – i.e., the “all or none” extremes in emotions so often seen in these children and the desire for only one “acceptable” emotion – i.e., “happy mom”), and the assigning of meaning to words (perhaps explaining again, inflexibility in speech). Damage to the frontal lobe also resulted in the inability to properly interact with others (i.e., socialization required flexibility), issues with task completion, and difficulty in problem solving (again, something that required – flexibility).

In trying so hard to build references for future use, children such as Zachary wanted things to be “this way or that way”. It appeared as though only “definite extremes” were acceptable.

There were many ways to teach "the in-between" situation to children with autism in order to show them that "references" included more than just the "extreme" scenarios of "this way" or "that way". Once Zachary understood there were “in betweens” and “different ways of doing things”, life became much easier for all of us. Using fractions as I described in my second book under the "Exercises" section was a great place to start.

Recently, I had read a book for Zachary that had well illustrated this issue and the need to teach the “in between”.

This book was *The Fire Cat* by Esther Averill (ISBN: 0-06-444038-9). In this book, a cat becomes a firehouse cat. Below was the part of the text on page 13 in this wonderful book:

***"Pickles, you are not a bad cat. You are not a good cat."***

After Zachary read that, he paused. I could see that Zachary was trying to figure out the answer... if not good or bad, what was he? Children with autism knew the “this or that”, but, in this case, the cat was “not bad” and he was “not good”. The book then went on to give the answer:

***"You are good and bad. And bad and good. You are a mixed-up cat."***

Zachary thought that was absolutely hilarious. What was great here was that this simple children's story provided for the "in between" situation and showed that there was more than just one extreme or the other. In this case, the answer was “both” and the book provided another answer as well... a third answer... “a mixed-up cat”.

I could then add “more answers” for Zachary... saying for example: “some days, he’s a little bit good and very, bad, but on other days, he’s a little bit good, and very, very, very, very bad”... or I could say, “on some days, he’s just a little bit bad, but very, very, very, very, very, very, very good”. Or, I could say, “on some days, he’s not good at all, he’s just, very, very, very, very bad”. This simple example could easily communicate “degrees” of the same thing – those

critical “in betweens” that Zachary so needed to understand in order to move away from a world of “this way or that”. Such statement could provide “degrees” or “shades” or “in betweens” for things like “good versus bad” but also “shades” for the same concept, for example, “shades of good *or* bad”.

In my opinion, it was books and software like this that were needed for children with autism. Books that taught "the in-between" in a fun way... books that made a statement, then provided the opposite... and then, provided the "in-between"... and in my opinion, the more "in-betweens" provided, the better! :o)

There were many ways to show "in-betweens"... you could do it with play dough to show big, bigger, biggest... and go a little more in depths by showing for example, big, a little bigger, a little bigger still, almost the biggest, the biggest. You could really do this with almost anything... spoons, twigs, rocks, etc. and then apply the concept to more abstract things like "emotions" and other aspects of life too where children had more difficulty [more on this later]. ***Once the concrete was used to teach the concept, it was in my opinion, much easier to teach the same concept in more abstract situations.***

During the day, I could easily say to Zachary, “you are a very good boy today”... and then, later expand on that and say, “you are a very, very, very good boy today”. Thus, again, with this simple example, I could reinforce the concepts of “shades of the same thing” and the fact that one did not have to be just “one or the other” – that there were different degrees to a whole lot of things in life! Teaching this concept of “degrees” or “in betweens” – that was one of the very primary keys in my opinion!

Another key in this, however, was that although “inflexibility” appeared to be a sign of frontal lobe damage, “categorization” was not in the frontal lobe, but in the temporal lobe and as such, herein in my opinion, was the potential to unraveling the problem of “inflexibility”.

***Everything in life had to be categorized in order to be understood. That included motions, emotions, word associations, etc. Thus, although there appeared to be “inflexibility”, via functions of categorization and the teaching of the “in between” some of that “inflexibility” could certainly be overcome. Thus, teaching the “in between”, in everything – be that emotions, different ways or motions for accomplishing a task, different ways to say the same thing, etc., was absolutely key since each of these “in betweens” could then be categorized in one or many categories. There was simply no denying that categorization functions were critical to overcoming so much in the life of the child with autism!***

It was critical to teach these children that there could be “other ways” to come up with the same answer – to teach them that there were often many ways of doing the same thing. For example, it was necessary to teach them that there were many ways to come up with the number 4. The “peg system” I had described in my third book, in actuality, could be applied to so much in the life of the child with autism. “Pegs” provided “first references” that could then be built upon. This concept was so critical that I wanted to provide for parents what I had written on the “peg system approach” in my third book, in order to once again, provide that “common ground” for all



parents. For those of you who had read book three, this would be a little repetition and I apologized for that, but, this was also “good review” of an absolutely critical concept. :o)

## Start Of Materials From Book 3 On “Peg System”

*In so much of what I had come to understand in Zachary, there could be no denying of the critical role of “that label” or “that reference” for him to draw on an the need to show Zachary “more options” or “more ways” to look at things as he formed new memories. The key in my opinion, truly was in making him see that, for example, there was more than one “reference” for adding numbers for example.*

I selected these particular examples because they involved short term, long term and working memory. These were but a couple of examples ... but, the concept was the same whether one was working with numbers, language or something else. It was also important to keep in mind my belief that the various parts of the brain were perhaps much more inter-related than we may have ever imagined.

Let us take first the simple concept of teaching basic addition. Teaching basic addition obviously involved the working memory, short-term and long-term memory. This also involved functions such as “categorization” and “auditory processing” in the temporal lobe and “higher functioning” in the frontal lobe. Although visual processing was usually involved, clearly, a blind person could learn math too.

If you considered how math was usually taught, it was normally something like this:

$1+1 = 2$ ,  $1+2 = 3$ ,  $1+3 = 4$ , and so on.

In other words, the “peg” or “constant” was the number “1” and what changed were the “other numbers”. It soon became evident to me that in working with Zachary, a child with autism, a child who very much lived “via reference”, there was an inherent problem in this approach. If I taught Zachary math in this way, I was teaching him “a reference” – that  $1+1 = 2$ ,  $1+2 = 3$ ,  $1+3 = 4$  and so on. Although this was true, I was in actuality, only providing **a partial reference** for Zachary. Given I knew his was a world of “reference living”, I personally, saw a huge problem with this. I was only providing one of many possibilities for the sum of “2”, or the sum of “3” or the sum of “4” and so on and not showing that – potentially – there were many other ways to come up with the same answer. Indeed, there were many other possibilities... and they increased tremendously the “bigger” the number for the sum.

As such, in teaching Zachary, I decided to “peg” the answer. In other words, I did the following for numbers 1 through 18 (because to do basic math, Zachary had to be able to add at least up to  $9+9$  to get to the stage of graduating to counting involving units of “ten”). In “pegging” the answer, I now provided for Zachary an understanding that there were “many ways” to get to a specific number, “many options” available for doing the same thing.

For example, to get the number 18, you could do:

18	+	0	=	18
17	+	1	=	18
16	+	2	=	18
15	+	3	=	18
14	+	4	=	18
13	+	5	=	18
12	+	6	=	18
11	+	7	=	18
10	+	8	=	18
<b>9</b>	+	<b>9</b>	=	<b>18</b>
8	+	10	=	18
7	+	11	=	18
6	+	12	=	18
5	+	13	=	18
4	+	14	=	18
3	+	15	=	18
2	+	16	=	18
1	+	17	=	18
0	+	18	=	18

*For Zachary, this did several things. It showed him first and foremost that there was “more than one way” to do the same thing and it provided for him “the references” he needed to draw from. Granted, you could never provide “all references” in “all situations”, but, by using math, I could provide the “concept” that there were “more possibilities” to something than “just one” – in anything... be that math, language, behaviors, routines, etc. This concept, in my opinion – the concept of showing “more ways”, “more options”, was key in getting children with autism away from their “inflexibility” in so many issues.*

*But, this simple concept also provided much more for Zachary. It provided for him “the pattern” to see how things worked and hence, the ability to understand how to “break the code”. Zachary easily picked up the concept that on one side, the number went down by one - on the other, it increased by one. Thus, he could actually “see” how this worked.*

*But, there was still more... for Zachary, this still provided a basic reference... a starting point that he could associate with – a reference easily retrieved and drawn upon or enhanced from there. The obvious “key reference” – though not the only reference for “18” – was the middle point – the fact that  $9+9 = 18$ . For children who loved that concept of “sameness”, this particular reference was key. From this reference point, Zachary could then in his head come to learn to “move up or down” in the chart.*

In my opinion, it was also necessary to focus on providing what I came to call “primary pegs” – those basic reference points – the starting points – that could then be used as “key references” in charts such as the “18” chart provided above.

Primary pegs – in basic addition – would include the following:

Primary Pegs				
0	+	0	=	0
1	+	1	=	2
2	+	2	=	4
3	+	3	=	6
4	+	4	=	8
5	+	5	=	10
6	+	6	=	12
7	+	7	=	14
8	+	8	=	16
9	+	9	=	18
10	+	10	=	20

These “same numbers” being “added together”, were in my opinion, **key** in the life of a child who loved “sameness” and as such, could very much be used to one’s advantage in teaching math based on a “peg system”.

But, there was still more... for Zachary, **this also provided that key “categorization” that was so necessary to the understanding of math, language and so many other things in life. A chart such as this provided for “inherently correct” places for things. That was good – initially – but in my opinion – this was but a first step. Eventually, I could easily go to “moving them around” though... thereby, once again, increasing flexibility.** For example, although the answer remained the same, I could now change the way “things appeared” in the chart. I could select a “random order” for all the ways to “make 18”, I could show addition involving “even numbers” first, then “odd numbers”. There were truly many things one could do to show that one answer could be achieved in many, many ways. The beauty of this was that it also prepared Zachary for the eventual learning of “negatives” being added into the chart. For example, I could show the fact that  $[-2+20 = 18]$  and so on. I could simply add in the “negatives” later on to further **build on the concept** - in this case - of math – although the application of this same concept could be done for many, many situations relating to many, many other issues.

I also taught Zachary the  $1+1=2$ ,  $1+2=3$ ,  $1+3=4$  and so on method, but, my primary focus, initially, was on my “peg system” whereby the “peg” was - the answer – not a “variable” within an equation! Providing the “normal method” allowed Zachary to then see how “pegging” different parts of the equation changed the answer! **In everything, I tried to provide for Zachary different “ways of looking at things” – “more ways than one” way!**

**Teaching Zachary math in this way certainly involved his working memory... and it made that “working memory” work in a “flexible way” – because now – he truly saw there could be – more than one way – and I could then apply that concept to much more than “just math”. I could “carry this lesson” to all aspects of life!**

As I worked with Zachary, so many things became evident to me. The simple fact was that whether or not a child had autism, all children - all persons - pretty well had the “same brain” – overall. Functions within the brain were all located “in the same place” regardless of whether or not one was “normal” or suffered from autism, schizophrenia, Alzheimer’s or any other disorder.

**A “disorder” in the brain resulted in just that – “dis – order” and the key was in providing once again for something that made sense – in breaking the code to how to once again – provide “order” so that things could once again be understood.** As such, these methods could be used for teaching – all persons...

There was no doubt in my mind, that in a child with autism, that “first reference” even if “inaccurate” could be “engrained” in the brain and committed to memory – just as easily as an accurate reference and hence, it was critical to always correct Zachary’s inaccurate guesses or inaccurate utterances during the day... his “inaccurate anything”. An inaccurate point of reference once burned into memory, in these children would be harder to correct at a later date because memories had a way of becoming “more solid” over time – even “inaccurate memories” or “inaccurate labels” (as I discussed in greater detail in my second book – Breaking The Code To Remove The Shackles Of Autism: When The Parts Are Not Understood And The Whole Is Lost!). In my opinion, it would take a great deal more work to “change a bad reference” in Zachary than it would in a “normal person” – and as such, I worked very hard at providing as accurate yet flexible a “first reference” as possible in teaching my son.

### **End Of Materials From Book 3**

Obviously, you could do the same thing by “pegging” the answer for subtraction. Again, a great deal more on this and many other topics was provided in my previous books – books I strongly encouraged all families to read.

Important in all this, however, was the fact that this same concept of “key pegs” could also be applied to language in conjunction with categorization functions [specific examples of that later in this text].

The last function of the temporal lobe I wanted to discuss in this chapter was that of the ability to distinguish between truth and a lie. Although at first it appeared this function was not related to the understanding of language clearly – it was! Repetition allowed the solidification of memories. Memories, once formed and burned into the brain, were not easily “reversed”. Memories, like anything else, could be categorized and that categorization would include a determination of whether or not something was true! The more a person heard something, the more they came to believe that “something” to be true – whether or not, in reality – it was. A person who was told that s/he was “retarded” or “stupid” – if told often enough, would certainly come to believe that. The fact that the understanding of language, auditory processing and memory were all co-located in the temporal lobe along with face/voice recognition (those we believed most were those we knew best) and the ability to distinguish between truth and a lie certainly appeared to make for a nasty situation when it came to this issue.

No man stated it better than he who provided perhaps the best example of the dangers that were simply waiting to be awakened via the manipulation of thoughts and memories as they related to self-worth and the perception of the worth of another human being to society.

***“If you tell a lie long enough, loud enough and often enough, the people will believe it.”  
Adolf Hitler***

Within the functions co-located in the temporal lobe, clearly was the ability to manipulate one's understanding of the truth via the manipulation of the understanding of language as it related to other functions in the temporal lobe.

Truths, lies, memories, faces, voices, sounds, smells, emotions, and – indeed - all sensory inputs - all of these things had to be categorized – that all key function located in the temporal lobe – a function located in a lobe not associated with “inflexibility” as was the “frontal lobe”. Indeed, categorization functions in the temporal lobe provided, in my opinion, the keys to greater flexibility in these children because categories could be made “flexible” in spite of “inflexibility” resulting from frontal lobe damage. The temporal lobe provided via its categorization functions, a way to increase flexibility in children such as Zachary.

**Categorization - a function, that in my opinion, held the keys to further releasing children from the shackles of autism.**

The topic of categorization was such an important topic in the life of the child with autism that, truly, it necessitated a chapter of its own because categorization spanned far, far beyond “just language” – categorization, truly was the key to “breaking the code” – to everything in the life of the child with autism! As such, this would be one of the primary topics in my next chapter – “Building Critical Bridges: The Key To Order And Understanding In The Midst Of Chaos!” For now, however, I needed to complete the “Updates” to the language section initially provided in book two.

There was no denying that absolutely all incoming sensory input needed to be not only categorized – but, integrated. The integration of sensory input in order to allow for the understanding of a single concept was a function located in the parietal lobe. The only sensory input actually located in the parietal lobe was the sense of touch. Perhaps this helped to explain why so many children with autism had such a heightened sense of touch. Keep in mind that based on everything I had come to understand in my own son and other children with autism, it appeared to me that those functions co-located within a specific region of the brain appeared to be much more inter-related than we could ever have imagined.

I also could not help but wonder if “heightened communication among co-located functions” did not help explain the very heightened sense of touch in so many children with autism.

Touch and somatosensory processing were co-located in the parietal lobe along with visual attention and the integration of sensory input to allow for the understanding of a single concept. If indeed their existed “magnified communication” among co-located functions, simply due to “physical proximity of these neurons” or due to the fact that the brain of the child with autism attempted to “compensate” for lack of communication among the various parts of the brain, would that not make one “overly sensitive” to issues of touch given “touch” was located in the parietal lobe – where sensory information was supposed to be integrated. If indeed “other sensory input” was not “making it to the parietal lobe” to be integrated, but only or primarily the sense of touch, co-located with the integration of sensory input function, provided input to this process, would that not make a person “more sensitive”?

Interestingly, sight, sound, touch and smell all seemed “stuck on high” in so many of these children. Why? I knew many of these issues had now greatly subsided in Zachary – especially since I had put him on digestive enzymes. Note that somatosensory processing and touch were co-located in the parietal lobe along with the sensory integration function. Digestive enzymes helped to break down offensive foods such as casein and gluten that were known to act as hallucinogens or natural opiates on the brains of these children. Still though, there was some sensitivity in Zachary when it came to the senses, and as such, I could not help but wonder about the “stuck on high control knob” when it came to sensory input in children with autism.

If that “sensory integration function” that allowed sensory input to be viewed as “one concept” resided in the parietal lobe, apart from the senses of sight, hearing, taste and smell, then, it stood to reason that if there was little or no communication among the various parts of the brain, the child with autism would have difficulty integrating all these senses in attempting to understand “single concepts” – and indeed – that was certainly what I had observed in my son and so many seemed to refer to as “sensory overload”.

If sensory information was not being properly processed by the brain and not properly categorized, would that not result in “a lot to deal with at once” as sensory input kept “coming in”? In my opinion, it certainly appeared to be the case.

A task that we all did *subconsciously* - the integration of the parts to the whole - something so necessary to the understanding and categorization of “the parts into the whole” [i.e., incoming sensory input itself and its categorization] – I found my son had to do *consciously* – at least until I started to make him understand “how things fit together” by labeling absolutely everything for him. That allowed Zachary to not only have “a label” but it allowed him to finally “categorize” his world and make sense of it.

For Zachary to understand “a pencil” for example, he needed to have the various parts of the pencil labeled for him – the lead, the eraser, the color, the wood, the metal eraser clamp/holder, the mark on a paper, the purpose of a pencil lead, of a pencil eraser, etc. Each and every little “part” of the whole had to be defined for him to help him understand what he was seeing and touching and the purpose of each part was explained, too, as much as possible.

It finally occurred to me that I had never actually shown Zachary how to hold a pencil. I think we all take it for granted that such simple things came “naturally”, but, for Zachary, that was not the case. It was as though he did not know “what to do with this thing”. As such, I decided to show him exactly how to hold a pencil.

I found I had to give Zachary time to familiarize himself with anything new in life. I truly believed this "familiarization process" Zachary always went through was simply his way of trying to make sense of new "parts" in his world. Pencils were no exception. I had purchased the biggest set of coloring pencils I could find a while back. Before Zachary could actually use them as tools, he had to "familiarize himself" with them. He had to align them, stack them, etc. until the "newness" was gone. Only then could I even begin to put a pencil in his hand and help him draw/write. I had found that to be true with almost all new tools.

In my opinion, if a child had difficulty perceiving the part from the whole, then the act of placing a pencil in his hand, by definition, introduced a new "part" to his body... one he was unable to understand and cope with... perhaps one he was unable to separate in terms of "what belonged to him" verses "what was a separate entity" in and of itself... because once these "parts" (the pencil and the hand) touched, to the autistic child, did they not become a "whole" that needed to be understood in terms of its parts... and unless the "parts" were well defined, Zachary, in my opinion, would experience frustration as a result of the simple act of trying to hold a pencil. It had now been quite some time since I had to introduce "a pencil" to Zachary. Yet, this was one of those things I wished I had understood and introduced to Zachary much earlier on because I now found myself in a situation where, when we did homework, Zachary understood the concepts well enough (i.e., basic math) but it took us a long time to get through a specific exercise because of his writing difficulties. I certainly wished I had started teaching him how to write much, much earlier on.

When I had first tackled actually teaching Zachary about pencils and how they worked, I was sure to label absolutely everything for him. Clearly defining the hand as an entity in and of itself, the pencil as an entity in and of itself, a sheet of paper in and of itself and stating "I'm putting the pencil in Zachary's hand" as I did this, I found helped Zachary with this issue of holding a pencil.

To define the pencil, I told Zachary about the pencil's color, that the "thing inside" was "lead for writing on paper" as I showed him how the pencil made a mark on paper when you used it... the pencil mark itself was also labeled as "a mark". When I first started using a pencil with Zachary, I used things he was familiar with – such as shapes and numbers - when I wrote as I said: "it's a circle" or "it's a five".

In addition, I defined the "eraser" as something to "erase a mistake" as I showed Zachary how to do it. Making a "mistake" in a familiar shape was an easy way to put across the concept of a "mistake" as I erased it. For example, I could state: "let's make a circle" but then, actually draw a square... Zachary would understand that "this is not a circle" and hence, I could say: "oh, no... that's not a circle... that's a square... I made a mistake... let's fix it" as I then erased the square and said: "all gone" and drew a circle in order to show him "the purpose" of an eraser.

Notice again, that every single aspect was defined... the "thing I drew", the "mistake", the "let's fix it"... to help Zachary understand the issue that "this is wrong but there is something we can do to fix it"... the concept of "let's fix it" became a HUGE coping mechanism for Zachary in terms of understanding how parts fit into the whole... as did the concept of "it's broken" ... or "it's stuck"... all these simple concepts helped him to cope with the world at times when it just seemed to make no sense to him... in so, so many issues... until they could each be individually addressed. I encourage all parents to use these simple phrases to help their children cope. For more on this, see Words to Cope, provided earlier in this text.

By saying: "it's stuck", for example, I could joke with Zachary about the fact that the pencil was in his hand, on his skin, without causing him too much stress. The concept of "it's stuck" allowed "things to be put together to form a new whole" without creating a huge amount of stress. This concept of "it's stuck", I had used to help with overall issues with touch, and with

anything else as it related to things "going together", like stickers on things, bandages on skin, labels on food cans, etc.

With Zachary, I found doing these simple things helped him tremendously. By working with familiar things, I could easily reduce stress levels to help him understand the issue of "creating a mark" without introducing a new stressful concept. At first, since I used a shape he understood and loved, his love of circles (a "whole entity" in and of itself) allowed me to trigger his interest as I helped him deal with the overall issue of holding a pencil. The sheet of paper also needed to be defined. I explained "a sheet of paper" to Zachary as being something "to write on" as I showed him how to make a circle or letter on it - something he was familiar with. As I moved on to "other markings", I defined those too, whether they were just "marks" or "sketchings", or scratches, etc. They were defined to help Zachary cope with this new concept of "writing". The sheet of paper, I further explained in terms of its color (i.e., "this paper is white"), its shape (i.e., "the paper looks like a rectangle" - as I showed him the outline of the paper with my hand), its surface (i.e., "it's smooth - as I used his fingers and pushed them across the page), etc. Thus using familiar concepts of color, shape and texture further helped with the overall issue of "writing" in terms of removing the stress from the situation.

Note that I would not use a "workbook" here - just one plain sheet of paper - at first, one that had no lines - then one with lines as Zachary became familiar with the concept of "paper". A workbook involved a lot more in terms of defining the "parts" that made up the "whole" in terms of a "workbook". The concept of "pages" to a workbook was a difficult concept for Zachary to grasp at first. A workbook (or any book) involved a "front cover", "back cover", pages in the middle - if not numbered, they became much harder to define for Zachary. Thus, it was extremely difficult to explain how the "pages" fit together to form a whole. In addition, a workbook could have writing on it and, in my opinion, if a child with autism did not yet understand the alphabet and how letters "fit together" to form words, then, that also introduced a whole new area to deal with. Plain paper was better, in my opinion, to get started with this issue of writing.

When I thought back to everything I had gone through to introduce Zachary to writing and the simple act of holding a pencil, it brought back so many memories of "what worked" and areas of difficulty and I now understood why certain things had worked.

For example, I now, without a doubt, knew that colors played a huge role in Zachary's life – and that included the area of learning. When I had first started to tackle the issue of writing, a friend of mine showed me a fantastic new mechanical pencil, marketed under the name **Rainbow Stix**.

These mechanical pencils had something I had never seen before - the lead that you inserted into the pencil had three colors - red, blue and green. Simply turning your wrist slightly as you wrote made you write in multiple colors. :o)

For Zachary, these mechanical pencils had provided that fascinating "unexpected" - multiple colors apparently coming from the same object. First, the mark was red, then blue, then green. Zachary had been totally captivated by these pencils right from the start! As I wrote, I called out



the colors. After I showed him how I could write in multiple colors, with the same pencil, apparently not doing anything to make the colors change, he just had to try it for himself - he picked up the pencil and started to draw/make lines on a piece of paper. He found these totally cool - and so did I! :o) The neat thing was that although the lead had three colors, as you wrote and the colors mixed, you ended up writing in a whole bunch of colors. Each day, I saw the importance of color in Zachary's life. For more on that, I encouraged all parents to read the chapter in my second book entitled [Color: The Pot Of Gold At The End Of The Rainbow©](#) in the life of the autistic child! :o)

I had purchased these pencils via my local Staples store. There were four mechanical pencils per pack, with 12 refill leads for about \$2.50. These pencils were made by Pentech (310-456-7799), a maker of children's toys and a subsidiary of Jakks Pacific, Inc.

I was glad I had found fun tools for teaching Zachary to write, but still, I certainly regretted not having started on "writing skills" much sooner.

I found that when we did Zachary's homework for example, that a page he should complete in a few minutes could take up to twenty or thirty minutes just because of his issues with writing. He knew the answers, but just could not write them down fast or well enough and I found that slowed us down tremendously. As such, this was one area – writing - I certainly encouraged all parents of children with autism to tackle as soon as possible. Now, things were much better than they had been when we first started to tackle this issue, but there was no denying that writing was still an issue for Zachary. The formation of letters was coming along well, but the speed certainly tried the patience. I found that if I simply held Zachary's hand in mine, and still allowed him to do all the motion, that this was somewhat helpful.

In writing, it was really within the last year that I also came to notice that Zachary actually had what appeared to be real physical issues with "just holding" the pencil. As I did more research on autism, I discovered that "limb apraxia" was common in these children. Although there was no denying that Zachary had to "understand" the pencil to want to use it, I came to see that it truly was as though Zachary had no physical strength in his fingers. So, I bought a couple of "squishy or sponge balls" that he could squeeze now and then to build strength in his fingers. That seemed to help too.

I also noticed Zachary was pretty well ambidextrous. He could do things with either hand and did not seem to always prefer one hand over the other - there was maybe a slight preference for left in writing, but, other things, he did with his right hand, like eating. So, I decided to focus on the right hand (we tried left, but I just found it too hard). I decided to provide a "reference" for him in order to show him how to hold a pencil. I showed him how to put his index finger and thumb to hold the pencil and told him to "put his fingers on the crack" - the "crack" being the part where the pencil sharpening ended and the "color" of the pencil started - that was "the reference" and he came to use it pretty well immediately when I just reminded him to "put his fingers on the crack". The other reference I had to provide had to do with the "sleeping finger" - the middle finger acting as a place for the pencil to "sleep on" along with the area between the thumb and index finger. From early on, these basic references I had found helped tremendously with "writing issues". Finding the "reference trick" – it appeared – was key for Zachary.

On parent discussion boards, I had read of other parents putting a rubber band around their children's fingers – not too tightly of course – in order to help hold the pencil in place. I had not tried that, but it certainly was an idea for children who had tremendous physical difficulty in simply holding a pencil.

As with everything, understanding the issues always made them much easier to deal with.

There was absolutely no denying that for Zachary, labeling everything had been absolutely key to his progress.

If incoming sensory input involved sight and/or sound and/or touch and/or smell, each aspect was defined as much as possible - everything heard, seen, touched, tasted, smelled. I explained everything I could to Zachary by providing him with as many labels as possible and as many explanations of those labels or sensory inputs as possible. **Providing explanations relating to - the “purpose of things” - in addition to - actual labels for everything - I found to be absolutely key!**

That was because a label provided an entity in and of itself, much as did “a purpose”. Even - “1/2” - once labeled as such, was an entity in and of itself that could be classified on its own, even though it was only a “part” to a whole. By providing a label for something – even fractions – that “something” became a “whole” in and of itself. Zachary used to have tremendous issues with doors, cupboards, or windows that were partially open either in the house or in the car - until I provided for him a label for the partiality by stating that “the door is half open” or “the car window is 2/3 open”, etc.

For Zachary, the label always provided the understanding he needed – the label to the “part” that could then be categorized in and of itself!

Although having to provide such levels of details appeared overwhelming, it really was not that difficult. **The key was to move Zachary to the point where he now asked the “What’s that?” question in order to understand his own world.** Zachary had finally moved to that stage and that had opened an entirely new world for him. When he needed to understand something or label something so that he could categorize it, he would now finally say: “what’s that, mom?” because he knew that mom had a lot of answers to help him make sense of his world and that helped tremendously in reducing his frustration levels.

Given these children truly lived “via reference”, ***I had to actually teach Zachary “what to say” when he needed help understanding something.*** As such, I literally would tell him: **“When Zachary does not understand something, Zachary says: What’s that, mom?...” so that he had the actual sentence he needed to use to help him get the answers he needed.** So many of these children had such wonderful memories that once told something, they had a tremendous capacity to remember it for “future reference”.

The life of the child with autism appeared to be as a huge puzzle and as such, as the child came to understand or tolerate his “puzzle” (i.e., his environment), often, leaving that puzzle or environment behind could lead to a tremendous amount of stress – because with a change in

environment came a whole new set of sensory input that now needed to be understood. This, in my opinion, was why so many of these children loved “routines”. It was also my opinion, however, that routines were exactly what these children did **not** need! When you made life a routine, you reinforced “sameness” and that was exactly the opposite of what you wanted. Teaching flexibility – that there could be more than one right answer or more than one right way – was in my opinion, absolutely key to getting these children on the road to a better life.

Certainly, everyone needed “some” routine in life, but, as with everything, it was a matter of “degrees” and in my opinion, the child with autism only needed as much “routine” as any other “normal child”. Life was anything but routine and children with autism had to adapt to life – not to a synthetic environment.

I discuss these issues in much greater depth in my second and third books – Breaking The Code To Remove The Shackles Of Autism: When The Parts Are Not Understood And The Whole Is Lost! and Breaking The Code: Putting Pieces In Place! I strongly urge all parents to read both these books, provided in full on my website.

Also discussed in my previous works and, in my opinion, very much related to learning language was the fact that Zachary loved anything that had to do with colors. Indeed, some autistic adults stated they coded their world based on colors. On a parent discussion board, an autistic adult once stated how he learned in school by “color coding” what the teacher was writing on the board. This was how he had learned his alphabet and had unscrambled so much of his life as a child. I had found that absolutely amazing, especially given what I saw in Zachary in terms of his absolute love of colors. It was, after all, in his “room of colors” that he started to actually speak – the day I had finished painting that room. Although I did not realize it at the time, the picture of “Zachary’s room of colors” had actually involved not only colors, but categorizations. This room had the alphabet on one wall, numbers on another, and shapes on yet another wall. I now had no doubt that Zachary used colors to somehow **categorize** his world – colors were simply “too much” a part of his world not to be playing a key role – of that, I was absolutely convinced! Granted, I did not fully understand the role of colors in his world, but there was simply no denying that colors were somehow very, very, key!

Colors, I knew were key to Zachary’s categorization of his world. Now, however, I also very much knew that they played a role in the control of Zachary’s emotions also.

The frontal lobe involved functions relating to motion, control of emotions and word associations. As discussed in my earlier works, Zachary had a few key phrases he used all the time. These included “green truck” and “blue circle”. In “Saving Zachary: The Death And Rebirth Of A Family Coping With Autism!”, I had written the following words in the chapter entitled “The Revelation”:

***“It explained why, when frustrated, if Zachary could not find something to spin, he reverted to “pretending” to be spinning with a finger or to some object that provided order and as such, it explained non-sense language...his walking around the house saying words that appeared to be totally out of context...such as “green truck”, “circle, square, triangle”...the reciting of all shapes, the alphabet with associated words for each letter, etc., prior to going to bed...there***

was order there! Zachary used to go around the house and say, “circle, triangle, square” , or “circle, circle, circle, etc...”, or “green truck” (had wheels and he loved to spin wheels... but also something concrete that “made sense” ), or “fan”, or “carousel”, ...they were all things that I had perceived as “non-sense language”, something so characteristic of autistic children, yet, now that I understood Zachary’s need for order, I understood this too... to him, these were not “non-sense” words, these were things that in his world...had order. Whenever he used these “non-sense” words, I now knew that he was giving himself an “order fix” as I came to call it. He did this when he was stressed out, or simply after a period of time when we had been watching a movie or doing something else that had basically no order to it”. [end of quote, book 1, Saving Zachary: The Death And Rebirth Of A Family Coping With Autism!].

Note again, the common themes here... color, control of emotions, motion, word associations... constants [i.e., things that did not change – such as shapes, letters, etc.]... categorizations... all those vocalizations that had once seemed so “nonsense”, once again, appeared to make complete sense. Control of emotions, motor activity, language production, word associations... all these things were co-located in the frontal lobe, and in my opinion, perhaps much more interrelated than we may have ever imagined! Interestingly, the identification of colors was located in the occipital lobe – not the frontal lobe. Yet, clearly, colors played a huge role in Zachary’s life. As such, I wondered if there were “other functions” associated with colors that could be involved or whether this part of the occipital lobe was actually “working properly” in these children and as such, they were “drawing upon colors” as a key to categorizing and understanding their world. I suspected this could very much be the case – that functions involving colors were working properly and hence were somehow being used in all parts of the brain – not just the occipital lobe.

I knew that Zachary very much categorized things based on colors. He remembered things more if they involved colors – both categorization and memory functions were in the temporal lobe.

I knew Zachary’s visual attention was always very much drawn by anything that involved colors. He loved to touch things that had color – such as my “yellow car” as he brushed his hands along the car each time he walked by it as he vocalized the words: “a yellow car”. He loved to play with a Rubic’s cube and although he clearly liked the puzzle aspect to that toy, he would usually ask me to make a “blue H” or a “green T” on one of the faces of the cube. As such, again, color clearly was key. It was not simply “make an H”, he gave very specific instructions – always involving colors! Visual attention, touch perception and manipulation of objects were all parietal lobe functions. As such, clearly colors were involved in Zachary’s parietal lobe functions too!

The absolutely fascinating thing about colors was that they appeared to involve the “crossing over” of senses. For example, some persons were said to “hear colors”. This phenomenon was truly fascinating to me. According to this particular website, <http://www.school-for-champions.com/senses/synesthesia.htm>, by Ron Kurtus, I quote:

***“Synesthesia was a condition in which the real information of one sense is accompanied by a perception in another sense. A person may see colors when hearing a sound or may***

*experience a smell when seeing a certain color. Such a person is called a synesthete. There is much to be learned about this phenomenon... Synesthesia is a linking of senses that seems to happen in a small percentage of the population. It is most often the experiencing of colors in association with other senses. It seems to be caused in the processing of information in the brain. There is much study needed to understand this phenomenon.” [end of quote, emphasis added, Ron Kurtus, , <http://www.school-for-champions.com/senses/synesthesia.htm/>].*

Hum... a “linking of the senses”... that was very interesting indeed. Could colors provide a way for Zachary to perform sensory input integration (parietal lobe) functions that had appeared to be so malfunctioning in the past via the use of colors and hence, almost “bypassing” that parietal lobe function if indeed that part of the brain was not working properly? That certainly was all very, very interesting to me given I knew colors were so very important in Zachary’s world! I wondered if children who suffered from severe autism could perhaps also suffer from color blindness and hence perhaps did not have access to what could indeed be a “backup” system for other functions in the brain.

More interesting however, was this quote as it related to the point of stimulation - again, I quote:

*“Syn-es-the-sia n. Physiol. Sensation produced at a point other than or remote from the point of stimulation, as of a color from hearing a certain sound (fr. Gk, syn = together + aisthesis = to perceive)...”*

*Synesthesia is an involuntary joining in which the real information of one sense is accompanied by a perception in another sense. In addition to being involuntary, this additional perception is regarded by the synesthete as real, often outside the body, instead of imagined in the mind's eye. It also has some other interesting features that clearly separate it from artistic fancy or purple prose. Its reality and vividness are what make synesthesia so interesting in its violation of conventional perception. Synesthesia is also fascinating because logically it should not be a product of the human brain, where the evolutionary trend has been for increasing separation of function anatomically.” [end of quote, emphasis added, <http://web.mit.edu/synesthesia/www/synesthesia.html/>].*

Colors... could they indeed be a pot of gold at the end of the rainbow for children with autism and their parents. I was now truly suspecting that, at least for some, this could indeed be true! Zachary, after all, had started talking again – in his “room of colors”!

The information on this site also stated that whereas a “normal person” saw, say, each of the letters on this page as black text, persons who experienced this phenomenon or type of perception saw each letter in very specific colors. As such, they had, for example, an almost automatic color-coded alphabet.

If that were indeed the case in some children with autism, clearly “sensory overload” from the simple act of reading a book for example would be overwhelming indeed given each letter, could potentially have its own specific color. Likewise, certain touches, smells and sounds could be

perceived as colors. If this were the case, then, could not concrete things like objects be perceived as colors too?

Particularly interesting to me was the first comment from this site – the definition of synesthesia – and the fact that it occurred **at a point other than or remote from the point of stimulation (i.e. not in the occipital lobe – where color identification would usually be perceived).**

This certainly could explain some of what I saw in my son in his constant need to seemingly color code so much in his world. I knew Zachary did not color code his alphabet, but I certainly would be paying much more attention to this particular issue in the future in order to figure out exactly what roles colors did play in my son – and how they impacted his understanding and/or categorization of his world. Clearly, I already knew colors were involved in controlling stress in his life – of that, I had no doubt – but, I needed to understand much more in this area!

I wondered for example how the thalamus played into this. The thalamus was involved in conscious and subconscious tasks as well as in the integration of central nervous system and peripheral nervous system input to the cerebral cortex. Clearly, the sense of touch was a “peripheral nervous system” input. How was it that Zachary appeared to consciously need to “order his world or sensory input” before he went to bed – a function that in a “normal person” occurred pretty well subconsciously? How was it that “verbalizing green truck” something Zachary used to control his level of stress or frustration? How was it that a touch could be perceived as a color? I knew that if two tasks were presented simultaneously – one conscious and one subconscious – the basal ganglia processed the conscious first (see book three for more on this critical issue that can absolutely impact “issues of safety”). How did that fit into all this? This was all, very, very interesting to me.

As I thought about this issue of the impact of colors in my son’s life, I could not help but remember how difficult it had been to teach Zachary colors. Zachary had a very difficult time learning colors - at least in expressing them to me. I worked and worked with him on that. Now that I looked back, and thought in terms of "order" and "partiality", and “references”, I was of the opinion that teaching "red, blue, orange, yellow", etc., was not the best approach.

***If I had to do this over again, I would have started with just one color – teaching Zachary the many shades of one color first!***

For example, I would teach "blue", "navy blue", "royal blue", etc., before moving on to the next color. You see, if I introduced "this crayon as 'red' " and then showed this one as "green", and this one as "blue"... that was what I was teaching a child... red, green and blue. And so, that created a specific reference. But, if I tried to introduce "another blue", or "another red" then I introduced a confusing "variation" for my child. So, I think if I had to do this again, I would start with variations within a single color, labeling each one (i.e., "royal blue", "navy blue", "light blue", "dark blue") before introducing another color. Again, this was just a thought, based on "order" and "reference living", but I believed this would make teaching this concept much simpler.

Using the computer's color palette under the font/colors/more colors/*custom* was also a fun thing to do to teach colors. Zachary was always fascinated with anything I did that involved colors and using the computer's color palette allowed me to show him how "adding more" of one color or "less of another" resulted in different shades and different colors. :o)

Below, I provided pages I had created for each main color for parents who wanted to try this approach. *Note that printers tended to distort colors during printing [when compared to what was actually seen on the computer screen], but, these at least provided for parents a starting point to teaching colors based on hues or shades of the same thing first.* Also, I would encourage parents to take actual objects around the house to show the child how the colors actually applied to his world.

Finally, I encouraged all parents to consider obtaining paints to show how, physically [using motion of paintbrushes] the "mixing colors" created new colors. This could also be done by buying colored plastic sheets and simply putting them one on top of the other and putting them up to the light. Actually showing the child "how to make colors" had the advantage of using "motion" and I strongly believed motion helped in the production of language in these children based on the fact that both production of language and motion functions were located in the frontal lobe.

For example, you could easily show a child that:

red + blue = purple

white + red = pink

white + black = gray

blue + yellow = green

yellow + red = orange

red + green = brown

and so on...

If indeed children with autism did somehow color-code their world it was necessary to teach them colors fairly early on because although I felt that colors could definitely be used to one's advantage in teaching children with autism there was also a problem in not understanding the child's color-code – especially if it was completely "made up" by the child.

If my suspicions were correct and the child with autism in some cases did "color-code" his world", I wondered if once that world was coded in his mind, if that child would stop wanting to actually "decode" life as it truly should be understood or as it was "normally" understood – thereby perhaps further slipping into his own world.

Although I firmly believed colors could be used to one's advantage in teaching the autistic child to decode life, I also believed that if a child was left alone to decode life for himself, that perhaps, this "code to life" created by the child himself, indeed could lead to the child withdrawing further and further into his own world and leaving the "real world" behind and as such, it was in my opinion, critical to establish "common ground" when it came to colors – and that meant providing labels for colors, so that communication between the child and the rest of the world, if actually somehow done via colors, would be enhanced as opposed to possibly hindered.

It was also important to note that some children were color-blind. Boys were more often color blind than girls. As such, if your child appeared to grasp certain colors but had difficulty with others, please keep in mind the fact that they could have difficulty with perceiving certain colors. Bright colors were often the easiest and best perceived by those with color blindness.

In working with color sheets, if I had to do this again – to teach Zachary colors - I would start with colors that had the least variation and then move to those that had the most and thus yellow was probably the best place to start to teach "different shades" of the same thing. Interestingly, yellow was one of Zachary's favorite colors and a color the human eye perceived rather well.

These "color sheets" were also available, as full page sheets, on my website under Parent Teaching Tools. In my opinion, it was best to provide only one color at once. As such, I would not introduce colors based on these smaller scale samples. I scaled these down only for discussion purposes in this text. In actually teaching colors, however, I would use full-page representations and teach the various shades of only ***one color at a time***. To introduce a child to different colors at once – as shown in these scaled down pages – would in my opinion, introduce too much confusion. Thus, I would introduce "only yellows" first. Although, not all colors were provided here, there were in my opinion, enough to ***teach the concept*** that there was more than one yellow, more than one blue, more than one red, etc. – and that was the key – teaching the concept. Once the concept was grasped the child should have little difficulty understanding "other colors".



## YELLOW

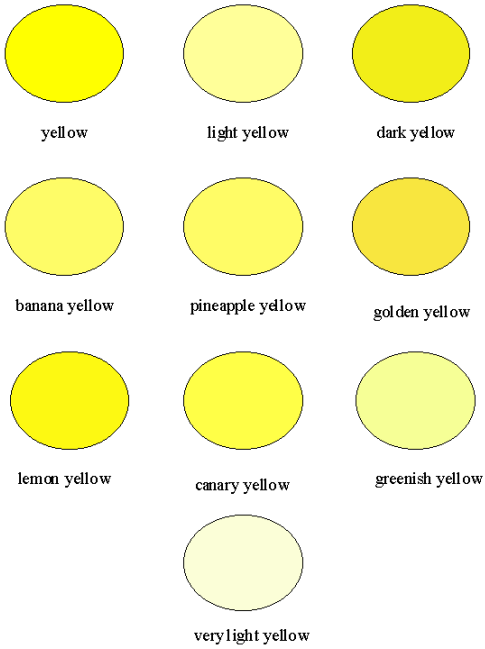

Copyright 2002 Autismhelpforyou.com

## ORANGE

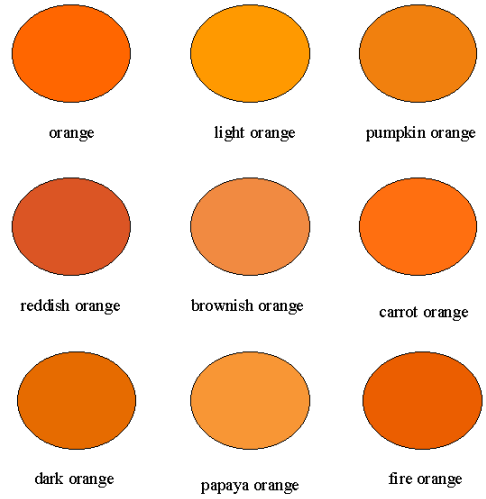

Copyright 2002 Autismhelpforyou.com

## BLUE

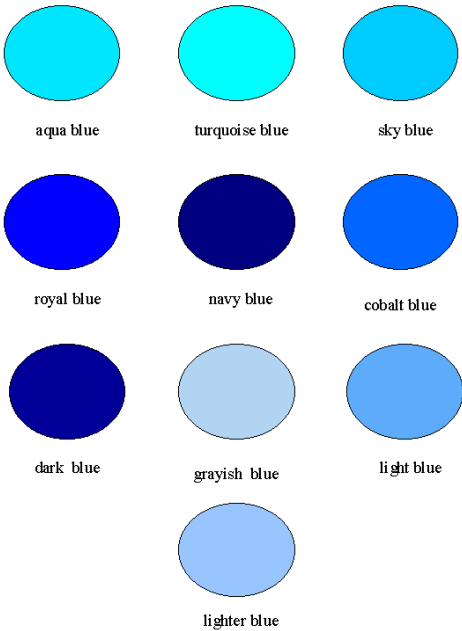

Copyright 2002 Autismhelpforyou.com

## RED



Copyright 2002 Autismhelpforyou.com

## GREEN

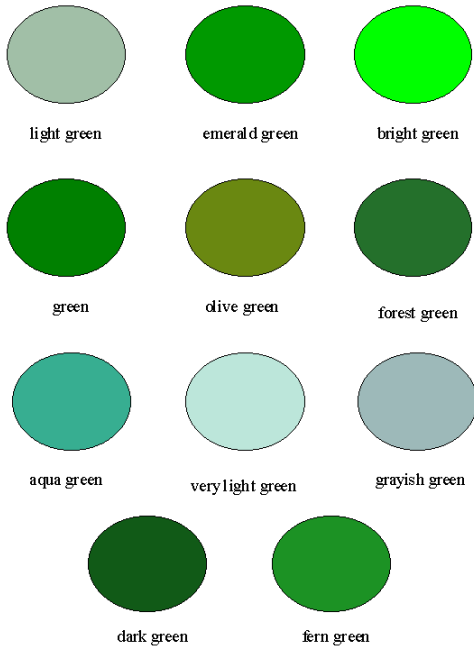

Copyright 2002 Autismhelpforyou.com

## BROWN



Copyright 2002 Autismhelpforyou.com

## PURPLE

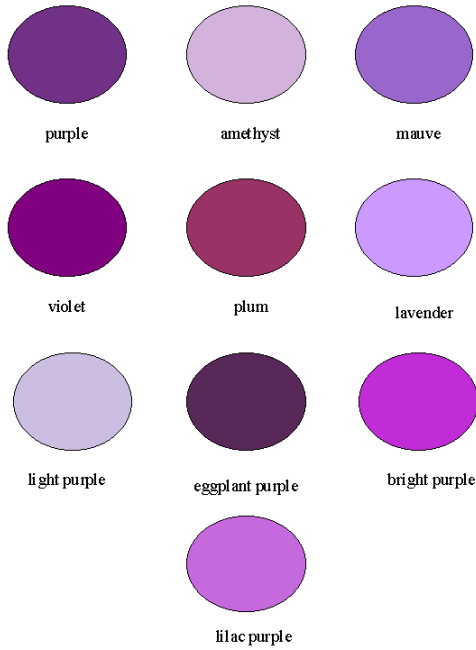

Copyright 2002 Autismhelpforyou.com

I knew for a fact that colors were very important to Zachary, and as such, if colors could somehow be important to all children with autism that certainly provided a great opportunity for using colors to one's advantage in teaching these children to "break the code" to so much in life – including language [more on this later]. ***The important thing to note was that in teaching colors this way, the child could see that there was "more than one yellow" and again, that had to help increase flexibility in these children in that they could see that things really did not need to be just "this way" or "that way" – that there could be "many ways" to see "kind of the same thing"***.

In Zachary, he clearly often spoke using colors. He also quickly grasped concepts that included colors. For example, in teaching Zachary about streetlights, I had told him: "Red = stop, green = go, yellow = be careful". Note that I often used equations (i.e., equals) in teaching Zachary new concepts. Now, however, he had been able to move somewhat away from "just equations" as now, he could state either the equation or "go is green", "yellow is be careful", "stop is red". ***In other words, he was slowly moving away from "equations" to "little sentences". Granted, he still used primarily "equations", however, the fact that he, himself, had started to move away from equations in certain areas of his speech, such as this, showed that he now understood the concept well enough and started to be a little more flexible in how he used it.***

In book two, given so much of this was still so new to me, I had concerns about whether or not using equations in language was a good or bad thing given equations had to be used in math also. For example, when I had first written the section on language found in book two, I was not certain as to whether or not I should be using "K+N = N" (as in knee) or "KN says N" in teaching the phonics for this sound. Now that I had a little more time with Zachary, clearly, the use of equations in language was not a problem for him. When Zachary read something, he did not have to say the equation – he just read the word because he now knew that K+N=N or KN says N. Given we were still a little way from "basic algebra", I no longer saw the use of equations in teaching language as a problem. By the time "basic algebra" came around, I suspected that introducing K+N=N as a math concept (i.e., thus, K = zero in this equation) would not be an issue. The simple fact was that there were plenty of "other letters" to use for that equation – like "x" and "y" and "z", or combinations of "a" and "b" and "c", and those letters, I had not used in "equations" relating to language and as such, I suspected that would help further reduce any confusion there might exist further down the road in relation to math. Thus, I was now perfectly comfortable with using "letter equations" to teach phonics and indeed, believed that for "special sounds", this was the best way to go!

Zachary had been taught phonics using sounds only. I had not used the motions approach taught in *The Phonics Handbook* by Sue Lloyd when I had actually taught Zachary his basic phonics. In my opinion, that meant that – at least in Zachary's case – auditory processing alone had been sufficient in teaching him phonics. Given that auditory processing and the ***understanding of language*** were co-located in the temporal lobe, this made sense to me. Yet, I now very clearly saw why the approach used in Sue Lloyd's *The Phonics Handbook* had worked so well for my nephew Andrew who had PDD. Motion was co-located in the frontal lobe along with the production of language, and as such, I now suspected that in the ***production of language***, motion was absolutely key!

As I had pulled out The Phonics Handbook to look at its teachings as I wrote this book, it truly appeared that the author had stumbled upon a very critical key to teaching language **production** without even realizing it. Everything in this handbook had to do with the **understanding** of language – the teaching of sounds for reading. Yet, in her approach and attempt at making phonics fun via the use of motions, the author had clearly stumbled upon what I now saw as one of the primary keys to language **production** in children with autism – motion! In attempting to teach the **understanding** of language, this author had uncovered a most valuable key to the **production** of language! The funny thing was that in the preface materials, no mention whatsoever was made of “motion” as it related to language – and as such, I doubted that this author understood what in my view, were the huge implications of her approach.

The introductory comments in this handbook did, however, also very much confirm my suspicions that sight was not key to the understanding of language and that children learned language better if they made use of sounds. As such, “sight reading”, a method used in so many schools today, was in my opinion, the worst method we could be using to teach children language – be that the actual production or understanding of language! In my opinion, The Phonics Handbook by Sue Lloyd was key not only to “phonics” but perhaps key to **actual language production** as well!

All of this made perfect sense given that auditory processing, memory functions and the understanding of language were co-located in the temporal lobe. The temporal lobe, however, had very little to do with visual perception. The only visual perception that appeared to exist in the temporal lobe had to do with face/place and body part recognition. Note that the method presented in Sue Lloyd’s The Phonics Handbook also included “body parts” as phonics were taught using motions that very much involved “body parts”. In addition, The Phonics Handbook made use of “associations” as children learned their phonics. The “associations” were not only “word – or letter - associations” but “motion associations” as well. Word associations and motions were functions co-located in the frontal lobe with language production and as such, it made perfect sense once again, that this approach worked so well for children!

Note that The Phonics Handbook had been created for “normal children” and yet, it had worked wonderfully with my PDD nephew – a child very much on the autism spectrum. As such, methods such as this one, surely could be useful in integrating children with autism in “normal classrooms” as well.

Thus, word associations, motions and language production were co-located in the frontal lobe and auditory processing, visual perception as it related to body parts, memory, voice recognition, categorization, and the understanding of language were co-located in the temporal lobe. Clearly, activating all these functions at once – as did the materials in The Phonics Handbook – in my opinion, was absolutely key not only in helping with the actual production and understanding of language, but in **helping to bridge functions of the frontal and temporal lobe – overall!**

**As stated earlier, in my opinion, finding “bridging functions” among the various parts of the brain was the key to re-establishing neural connections that may have been severed – and clearly, word associations in the frontal lobe provided a key bridge to categorization functions**

**in the temporal lobe. Word associations were nothing more than a very specific categorization and phonics were but a form of word association – the association of a letter and sound – and hence, the merging of these functions provided for parents of children with autism, perhaps the best opportunity for actually producing language in children that were non-verbal and increasing the understanding of language as well!**

**If my theory were correct that co-located functions were much more interrelated than we may have ever imagined**, that meant that by using motions, production of language, and word associations in the frontal lobe and bridging over to the temporal lobe's categorization and body part recognition functions - motion and - word associations - especially - provided in my opinion, the means of allowing for greater communication between the frontal and temporal lobe **overall**.

**Indeed, if the understanding of language was tied to almost all other temporal lobe functions, as very much appeared to be the case, then any “bridging over” in my opinion, had to also provide an opportunity for “bridging over” to other functions as well** – and that – in my opinion – had tremendous potential within it for teaching children with autism – or any person with communication issues between the frontal and temporal lobes.

This also explained why we saw echolalia in children with autism. Echolalia – the production of language and repetition of words – words that had “associations” - in my opinion, was but another way of “bridging” the frontal and temporal lobes – a way of breaking the code – to language!

In thinking about all this, as I looked back on so many things we saw in children with autism, I could not help but be totally amazed at how the brain of children with autism – and I suspected of all persons - appeared to work. It was as though these children inherently recognized that given their limitations in terms of communication among the various parts of the brain, they inherently knew to use as many functions as possible in “breaking the code” to everything in their world. For example, in engaging in echolalia or the parroting of words and sounds heard, these children were drawing on functions involving 1) “voice recognition” – the recognition of not only the voice of the person speaking, but of their own as well, 2) repetition functions, something so key to solidifying memories, 3) additional auditory processing – as both the sounds of others and their own sounds now also had to be processed, 4) face and voice recognition functions as they focused on the mouth of the speaker, 5) visual perception – again relating to the face and mouth, 6) the ability to distinguish between truth and a lie given repetition solidified what we believed to be true, and finally, 6) the all important function of categorization.

Thus – echolalia or the parroting of another person's speech - a behavior we had for so long seen as “mindless repetition” in the children of autism, in actuality, was in my opinion, the child's amazing way of activating as many parts of the temporal lobe as possible in an attempt to “break the code” to communication! Truly amazing indeed! How we could have seen echolalia as “mindless parroting” for so long was truly a testimony of how “retarded” we were in understanding this issue and how “advanced” the child's adaptation mechanisms for “breaking the code” to language – and so much more - truly appeared to be! Needless to say, my respect and admiration for the determination and adaptation of the child with autism – a child faced with

so many challenges – had increased tremendously, and the admiration I had once had of “experts” had been equally – decreased.

The determination of these children to “break the code” – to everything in their world – was absolutely amazing to me. I now understood the need for those “order fixes” I had so clearly seen in the past with Zachary. These had been his way of not only trying to “break the code” in categorizing his world but also his way of coping when his world seemed to so very much fall apart as he failed to understand it and those around him had so failed to provide that critical understanding for him. I now understood what I had once seen as an almost “fanatic need for order” – a need I now clearly saw as a means of making his world – make sense!

In thinking of the many, many children who had been left in a world of their own because we had so failed to understand them, my heart could not help but feel - tremendous sorrow.

I now finally understood so much in my son and that understanding on my part had made such a huge difference in his life. Much of his stress and mine were now gone. I now had a better understanding of how I needed to teach him and it was this understanding I hoped to provide for other parents as well in order that perhaps our journey with autism could help so many other families as well. I now had a son who could once again communicate with me – a son who now finally understood that if he did not understand something, he just had to say: “what’s that” and someone would now be there to help him understand his world – to help him – “break the code” to so much that had once been but a pool of confusion in which he had been drowning. Zachary and, indeed, our entire family, had now learned “the basic strokes” to moving forward in helping to remove not only Zachary – but our entire family – from the shackles of autism that had once so firmly grasped and suffocated our family and so painfully weighed us down as we all struggled to understand and overcome this disorder we had once only known as – “autism”.

Living with a child who had autism had truly been a lesson, at least for our family, in how little we had understood in so many areas not only in these children, but in the human brain as well and how the result of that lack of understanding in even the basics had been so very detrimental to so many – for so long.

As had so often been the case in my journey with autism, so much of what I had once known to be true of autism based on what I had been told by “the experts” had totally collapsed when it came to the issue of communication in children with autism. What I had read and heard of autism over the last 20 years had been but a great - deception. Once again, what man had known to be “so true” of autism – that echolalia was “just mindless parroting” – had proved, for us, to be exactly the opposite of what we had once thought to be true. This “mindless parroting” now appeared to be a very powerful attempt and mechanism in understanding language.

Because we had failed to understand, we had applied a label of “retarded” to so many children. Yet clearly that label belonged on someone else. I knew many would take offense to that statement. Quite frankly, I took offense at the labeling of children with labels such as “retarded” just because they were not understood. I took offense at making a child a further victim – a victim of a label - by those who were “experts” who chose to further victimize children and the mentally ill rather than recognize their own limitations.

My opinions on this issue were not an attack on a specific person, but rather, an observation of society overall because truly – it was all of society that had so failed to understand these children and given them labels they simply did not deserve. I very much also included myself in the “retarded” in this issue because for 20 years, I too, had failed to seek to understand these children and just accepted “a label” – an easy copout – for the failure to understand a child or person with mental illness, although clearly, I had not been “working this issue – for decades” – as had the CDC and NIH!

It was not until this issue touched me personally that I truly felt the need to understand and the need to find answers when all too often the answer I had seen in almost everything relating to autism was - we simply do not know or understand. No longer would I ever accept a “we don’t know” as an answer and just leave the search for those answers to someone else. No longer would I accept the lies of the CDC when it came to vaccines and neurodegeneration. To this day, this organization continued to argue that vaccines were safe when, clearly, they knew otherwise. My son did not have another sixty years for society to figure this out. As his mother, it was my duty to seek those answers – myself – answers to help me to truly understand my son – my only son – a little boy whose precious little butterfly kisses - I simply refused to let - slip away!

The extent to which we had so failed to understand so much in children like Zachary – for so very long - and the consequences of that lack of understanding were in my opinion - simply overwhelming. Was it any wonder so many children with autism were non-verbal and that so many still lived – in their own world!

***“We cannot order men to see the truth or prohibit them from indulging in error.”***  
***Max Planck, Philosophy of Physics, 1936***

***“If you tell a lie long enough, loud enough and often enough, the people will believe it.”***  
***Adolf Hitler***

***“We still do not know one-thousandth of one percent of what nature has revealed to us.”***  
***Albert Einstein***

And herein were the dangers of assuming anyone was “an expert” when it came to understanding so much in life! When answers given to what we saw in autism were “we don’t know” or “we don’t understand”, I now knew to “keep looking”, because, clearly, there had to be answers out there!

I certainly did not consider myself “an expert” in autism – but I certainly was an expert when it came to my son. No one knew him or understood him better than I did and it was as a mother only – not an expert – that I shared my story in the hopes that, perhaps, our story could help another family build a bridge of communication between even just one more mother and child – or father and child.

Like structures no longer cared for and broken bridges, so many lives had collapsed under the weight of autism... and now, it was my hope that our journey helped other to rebuild their

broken bridges and broken lives also. The road could certainly be long, but there was simply no denying that it could be very, very rewarding also!



## Building Critical Bridges...

### The Key To Order And Understanding In The Midst Of Chaos!

As I now thought about so much as it related to my son's autism, there was no doubt in my mind that much of what I saw in Zachary had been explained by my theory of little or no communication among the various parts of the brain and the fact that there appeared to exist heightened communication among areas co-located in the brain. So, so many things had finally come together to allow me to understand Zachary.

Although assuming little or no communication among the various parts of the brain appeared perhaps to some to be "rather drastic", given the University of Calgary experiment showing neural degeneration due to mercury exposure, showing neurons totally devastated by mercury, neurons that shrank to approximately half their original size, it appeared to me that this assumption was perhaps much more in the "ballpark" than one would expect, especially since so many key neurotransmitters also seemed to be out of balance in these children. The simple fact was that, as explained in books 2 and 3, this assumption actually explained a great deal of what we saw in children with autism. In my opinion, there simply could be no denying that.

Parents who had not yet viewed the University of Calgary video on neural degeneration were encouraged to do so. A link to this most compelling video was provided on my website at <http://www.autismhelpforyou.com>. This experiment done by the University of Calgary was absolutely a major piece of the puzzle – captured for all – on video!

The University of Calgary experiment results by Christopher C.W. Leong, Naweed I. Syed and Fritz L. Lorscheider of the Faculty of Medicine, Department of Physiology and Biophysics at the University of Calgary, 3330 Hospital Drive NW, Calgary, Alberta, Canada T2N 4N1 were published in the British journal ***NeuroReport (Leong CCW, Naweed IS, Lorscheider) FL, Retrograde degeneration of neurite membrane structural integrity of nerve growth cones following in vitro exposure to mercury, published in Neuroreport Volume 12, Number 4, 26th of March 2001, pages: 0733-0737.***

To view this compelling video from the University of Calgary, families could also go to: [http://movies.commonscalgary.ca/showcase/curtains.php?src=/mercury/Lor2\\_QTS\\_300kb\\_QD.mov&screenwidth=320&screenheight=256](http://movies.commonscalgary.ca/showcase/curtains.php?src=/mercury/Lor2_QTS_300kb_QD.mov&screenwidth=320&screenheight=256). More information was also available by going to <http://www.fp.ucalgary.ca/unicomm/Gazette/April4-01/mercury.htm>.

There could simply be no denying that these scientists had captured on video something that appeared to explain so much when it came to autism, and I suspected, many other disorders as well.

**Note that mercury had a half-life of twenty (20) years once in major organs like the brain – and as such, once it entered the system, it was pretty well there to stay – there to create decades of damage to human tissues! Obviously, it would be foolish to assume the damage would stop at "one neuron" or "one cell". If mercury did this to neurons, what was it doing to other tissues in the human body?**

This video certainly provided at least one explanation as to why it seemed that the various parts of Zachary's brain were simply not communicating properly and why Zachary's world had for so very long been such a world of complete frustration as he so desperately attempted to understand it.

I now knew that echolalia - something so very, very common in these children was not "mindless parroting" - but rather an attempt at understanding and categorizing language. Clearly, in Zachary, echolalia was "language production" that was generated in an attempt to create word associations and categorization that could then be used for future reference. As I thought about Zachary's language development, clearly, much of what I had seen in Zachary had involved word associations without proper categorization.

What could start out as echolalia usually quickly moved into language based on word associations as past references were drawn upon by Zachary's brain in the production of language. The following were words I had written in book 3 as they related to this issue of word associations without proper categorization - I quote:

"If you looked at functions in the frontal lobe, they included language production and "word associations". Thus it was very likely that the reason those suffering from these disorders spoke in "word associations" was because they were simply drawing on their "databank" of words that were *somehow* linked - or associated - and that was what "came out" in "language production" - almost "automatically". That would imply that language production functions and "word association" functions were somehow associated - and I suspected very closely associated *with "word associations" somehow appearing to actually "trigger" language production.*

Zachary had provided for me countless examples of speaking in "word associations". For example, he had a video with the phrase "easy come... easy go". Upon hearing that, he had stated: "No... not easy come... easy go... - easy stop... easy go"! To Zachary, "stop and go" went together much more than did "come and go".

Another example involved the word "year". For quite a while, when he heard the word "year", he automatically said: "Happy New Year". On another occasion, upon seeing a balloon his sister had brought for him from a restaurant, he immediately stated: "A blue balloon... it's a party"!

In terms of word associations or what I called living via "reference communication without categorization", there were many more examples of this in Zachary. For example, I once said, "sit up, please", he answered "stand down, thank you". Thus, if sit was associated with stand (opposites), up with down, and please with thank you, his response made perfect sense. Likewise, we were once driving to a nearby town for errands. On the way we saw a truck full of green cabbages. Zachary had never seen such a thing. I pointed it out to him and said: "Look, Zachary, a truck full of green cabbage". The word "cabbage" produced the following response from Zachary: "Red cabbage, juice". Zachary had recently seen me making juice in a juicer - using red cabbage - and hence, again, this "word association" made perfect sense. Other

examples included, "hot sun" - "cold moon", "cold ice" - "hot water", "wake up" – "sleep down", etc.

Once, I had asked Zachary if he could hear my heart beating as he put his head on my chest to hug me one morning. He answered: "Yes". I said: "That's my heart". He answered: "heart... rectangle". Two shapes. Again, "reference communication" - speaking by using associated words! Thus, his brain used one word and looked for "references" from past experiences and based on what was in his "databank" Zachary made "connections" or "associations" that truly did not belong together because clearly – his "categorization" functions – located in the temporal lobe – were not speaking with his language production and word association functions – located in the frontal lobe.

Again, there were many, many of these "word association" verbalizations I had seen in Zachary. Reference communication without proper categorization and reference living – in my opinion, there was absolutely no doubt that this explained what I had seen so often – and continued to see in my son!

With Zachary, I had always found he absolutely loved spelling. I now knew why. This was one of his greatest tools in "breaking the code" to life. For example, when by a campfire one day, Zachary noticed the sparks flying in the air as more wood was added to the fire. I said, "Zachary, watch out for the sparks". Then, I said: "Sparks - How do you spell sparks, Zachary?" This was a new word for him. He replied: "Sparks... How do you spell sparks, mom?" I spelled it for him - he repeated the word and then spelled it himself and repeated it again. That was pretty well always the routine with new words - he wanted the spelling, spelled the word himself and then committed it to memory - and voila - another piece of his world was understood and made sense of.

The interesting thing in all this was that spelling out loud was used to help him understand language. That brought me to an interesting point. Zachary could clearly understand the meaning of words I provided. That would involve hearing the word, spelling it and associating a meaning to that word. Thus, both the frontal and temporal lobe would be at play here – and thus, he had to automatically be forming "categorizations" and "word associations" himself for future reference. In my opinion, that seemed to indicate that the issue was not one of acquiring the meaning of the word – something he could easily do - but rather one of retrieving it when required. Zachary was easily able to answer: "What's that?" when I asked him "what those flying things were in the air during another campfire". So, he could retrieve the meaning of words and answer, "It's a spark", just fine. Yet, even though he understood words, and what they represented, when it came to reading and the retrieval of that information using visual input, he did not seem to understand the meaning of words nearly as well. He could read almost any word just fine (at age six), but if I asked him a specific question about something he had just read, at least initially, he just could not seem to answer it, even if what he read was just a short sentence.

By the time I had completed this text, he had come a long way in this area, but, "situation questions" were still very much an issue.

Initially, it seemed the issue was not one of “understanding” the words or the question being asked as much as it was one of going through an entire “database” of “word associations” and forgetting the initial question asked as he “got lost” in the “word association mode”. A word spoken or read could easily trigger another... that could then trigger another... that could then trigger another. And hence, in my opinion, the issue, at least initially, for Zachary was not one of understanding words as much as it was an issue of word retrieval and given that for Zachary, “word associations” were nothing more than “words without categorization” (as you should normally have), it certainly made sense – and the root of this problem, I suspected was very much due to the fact that there existed limited communication among the various lobes or parts of the brain.

Note that although language production was located in the frontal lobe – the understanding of language was located in the temporal lobe. If those parts of the brain were not communicating properly, how would you possibly come to understand language and then be able to provide an appropriate, verbal response?

The verbal response (production of language in the frontal lobe) necessitated “things” or speech be categorized. Yet, categorization functions were not in the frontal lobe with the production of speech functions but rather in the temporal lobe.

***The key to “bridging” these functions had to reside in the functions of “word associations” (frontal lobe) and “categorizations” (temporal lobe) because word associations were nothing more than a form of categorization! “ [end of quote, book 3, *Breaking The Code: Putting Pieces In Place!*].***

By the completion of this text, I came to the realization that Zachary also did not know “how” to answer a question – he did not know “how to build a sentence”. One word answers were easily given, but answering with a sentence was much more complicated. Zachary still very much preferred his one or two “introductory words” to his answers... words like “it’s a...” or “that’s a...”. Short sentences were coming along, and I knew he had the “capability” to physically utter them. Yet, Zachary, without a doubt still preferred to “talk in labels or commands”. I now realized that to get passed “labels and commands”, Zachary simply had to be taught “how to build a sentence” in a fun and easy to understand way.

As such, the last one hundred and fifty (150) pages or so of this text were devoted to actual exercises I had put together to help Zachary in this area. I now realized that Zachary understood “my questions” almost as well as any other child would. His difficulties now resided in “providing the answer”. I knew he understood. I knew he knew “how to speak”. The thing he did not know was how to “build a sentence” – he still did not understand the parts of speech – and in order to use speech – he had to first be able to understand how it worked – and, for Zachary, that meant being able to “categorize” speech – much as you would categorize anything else.

Not only did word associations in conjunction with categorizations provide a valuable opportunity for helping these children to decode their world, but, clearly, word associations themselves appeared to be tied to language production itself – and as such, even in “building

sentences” and showing Zachary “how to do this”, I would be careful to use “specific words” and word associations that I knew he loved.

In Zachary, just hearing a word on my part was enough to generate “language production” - it seemed – almost automatically generating a particular response – almost without even thinking about it. In other words, it appeared to me that, at least in Zachary’s case, **word associations triggered language production somehow**.

Time and time again, I had seen this in Zachary – on countless occasions. The best example I could provide was the following – an example I would simply reproduce here – an example taken from my second book- Breaking The Code To Remove The Shackles Of Autism: When The Parts Are Not Understood And The Whole Is Lost!

*“I usually said: "sit down" when I told him to sit in his chair to start working on his computer. On this day, he was already sitting, but, he was very slouched, almost to the point of falling off the chair. So, of course, I said: "sit up, please". When I said that, he replied: "stand down, thank you".*

*He was making "opposite associations" in trying to understand his world. If the word "up" went with sit, then, obviously, to him, the word "down" had to go with the word “stand” and likewise, the word “please” had to go with “thank you”. Obviously, to counter such reasoning, I must admit was rather difficult for me at first. I simply decided to "show Zachary" the act of "sitting up" and to then show him that you could not "stand down". Instead, I showed him "lay down", "stand up", etc.*

*Zachary had been trying to “combine words” to figure out how they fit together in order to provide for himself a “reference” he could draw on in the future. These attempts at figuring out how words fit together and how they could be used in the future, I came to call “reference communication” since Zachary created for himself “references” of how words could be used for future use!” [end of quote from Breaking The Code To Remove The Shackles Of Autism: When The Parts Are Not Understood And The Whole Is Lost!].*

This example best illustrated that Zachary, indeed, lived by reference and word associations. As I thought about this over time, another thing occurred to me – Zachary had stated: “stand down, thank you” – it appeared to me – ***without even taking the time to think about his reply*** – it was in my view – ***automatic!*** It was as if he did not even have to think about what he had said – upon hearing “sit up, please” he had automatically responded “stand down, thank you” – in an instant. This, too was critical and truly indicative of how language production appeared to work within Zachary. The words I had stated had generated an apparently **automatic retrieval – for each word** – of opposites – **with it seemed to me, no thought being given to the process itself as it related to appropriateness for the situation**. What had for so long been referred to as “nonsense language” now held the keys to unraveling how to produce language in these children – language production, I became convinced – was a function of word association! It was that ***“automatic retrieval” resulting in actual, almost instantaneous verbalization or language production*** that had – without a doubt – convinced me of that! It was critical to note that **word associations** (frontal lobe) were **nothing more than a type of categorization** (temporal lobe)!

*Thus, to get a child to talk, perhaps the best way to do so, was to use word associations – especially things like opposites – and to work from there to “expand” associations or speech production. In addition, working with colors and objects as “word associations”, I also believed could be most valuable (i.e., using the word red and at the same time showing “red objects” like apples, etc.). Given that I believed functions within a region were much more inter-related than we may have imagined, I could certainly also see things like “smell” being helpful in language production (i.e., not only saying “red” and showing a “red” apple as one said “red”, but also allowing the child to “smell” the apple to help solidify the word association). Finally, I would also include motion in attempting to build these word associations (i.e., just the act of smelling an apple was a “motion” and given motion was co-located in the frontal lobe with smell, language production and word associations, I believed it was key to “draw” on as many co-located functions as possible).*

**The key was to begin to at least “build references” that could be understood and drawn upon for language production and using as many co-located functions to do so and as many “bridging functions” as well to help in starting to build bridges and new neural connections across the various parts of the brain. [end of quote from book 2]**

When I had asked Zachary to “sit up” while he worked at his computer, his reply - “stand down, thank you” – had, in my opinion, been so fast that *it literally appeared to have been almost “automatic” – basically requiring no thinking on his part. It was not only the “oddness” of Zachary’s response that had captured my attention as he verbalized this – but also the speed at which his response had been provided.* This verbalization of word associations involving opposites truly appeared to have occurred “without even thinking about it” – and it had been this simple phrase – “stand down, thank you” – that had helped me to topple my entire puzzle when it came to understanding speech in Zachary once I turned to brain structure and function in attempts to understand what I had heard.

A “normal person” would have to think about the “opposites” to the phrase “sit up, please” – even if only very, very briefly - in order to come up with “stand down, thank you” as a response. But that had clearly not been the case with Zachary – his response had clearly been “almost automatic”, and hence, my utter amazement at his response, its “oddness”, its “speed” and my reason for now believing that word associations in these children could somehow perhaps help to actually “trigger” language production.

Zachary could literally “lose himself” in the language production or verbalization of word associations. He could start with one association and then move to another... and another... and another... and another... and so on.

If “word associations” (a frontal lobe function co-located with language production functions) somehow triggered language production, that certainly could help explain why Zachary could literally “lose himself” in “word association mode” and forget the original question. As Zachary’s understanding of language increased, falling victim to “word association mode” was something that seemed to happen less and less.

Word associations clearly were “categorizations” of some type that did not necessarily take into account situation context. As such, children with autism clearly often provided “word associations” which were completely out of context... word associations that were not properly categorized for a given situation.

Given that word associations were co-located with language production in the frontal lobe but that categorization functions were co-located with the understanding of language and memories in the temporal lobe, it was in my opinion, not surprising that this was what we saw in children with autism when it came to language production since it truly appeared these parts of the brain – the frontal lobe and the temporal lobe – were not communicating properly when it came to language functions. Yet, as Zachary came to “decode his world” more each day, and most likely came to build new connections within his brain, he continued to improve.

Note that if the temporal lobe was damaged that could result in short-term memory loss and interference with long-term memory. Memory functions were also located in the hippocampus – that part of the brain most impacted it seemed – in Alzheimer’s.

Damage to the hippocampus would prevent one from making “new memories”. The hippocampus was involved in long-term memory formation.

This certainly helped to also explain why conversation was so difficult for these children. To understand language, you obviously had to be able to properly categorize not only sentences themselves, but the context also.

***I now had no doubt that what we were seeing in what had once been called “nonsense language” – what I now referred to as “reference communication” – was nothing more than language production (frontal lobe) involving word associations (frontal lobe) without proper categorizations(temporal lobe)! As such, clearly, this “language production” was not “nonsense language” because, clearly, when understood for what it was – reference communication based on word associations - it made perfect sense!***

This also explained why Zachary “made up” his own words. By making up his own words for things he needed to understand he was building references for future use – he was building his own word associations – words that he could then use in “reference communication”.

There were many, many examples of this in Zachary. Made up words included things like: “a kisshug” to represent the activity of giving both a kiss and a hug at the same time, “a trucktrain” to represent a train that had truck trailers on it, “a cartrain” to represent a passenger train, and on and on and on. The fact that persons with autism and schizophrenia made up their own words truly was amazing to me. It made me wonder if “making up words” was not simply part of man’s natural behavior in terms of developing communication – in other words, that if a person was not “taught language”, they would simply develop their own anyway. Zachary had many of his “own words” that he had made up and quite frankly, they actually made a lot of sense. Other family members started to make up their own words too when those words we had currently available were not “good enough” to explain a concept to Zachary. Actually, the concept of “making up your own words” was rather brilliant and again, I could not help but marvel at the

ingenuity and adaptability of children with autism because in attempting to break the code to life, they had on their own figured out that if the word they needed had not been provided to explain an object or concept – they simply made one up and committed it to memory! Truly amazing indeed!

Indeed, if you thought about this, this was simply an extension of something we already see in language – normally – compound words – and Zachary had figured out how to make them – all on his own.

There were so many things to learn in language and “how it worked” – and yet, here in my son with autism – was the perfect example of a child who had figured out how to make “compound words” all on his own. This was truly, truly amazing to me.

Compound words usually consisted of two words put together. However, when those two words were “put together” the new word was may or may not be related to the “old words”.

Amazingly, however, Zachary’s compound words were all “related to” the “two original words” in some way. He had actually figured out how to make compound words on his own. At the time, I had not seen this for what it truly was – I had simply found his “new words”, his “made up words”, cute – but there could be no denying that this was indeed what Zachary had done.

As I thought about “compound words”, there could be no denying that surely, Zachary would have heard “some words” that were compound words as those around him spoke – and he appeared to have simply applied the concept on his own to the building of “new words”. Granted, these were not “normally accepted Webster dictionary compound words” – but, they were indeed “compound words” – there could simply be no denying that!

The more I thought about this, the more fascinating it was to me. It was now no wonder that Zachary had been thrilled at learning about “compound words” when he finally did see there were many of these. As his language skills had progressed, he had come to do more and more in terms of “reading software” and some of that software – in time – came to include the subject of “compound words”. Zachary absolutely loved “putting the words together” to get “new words”. I know understood why that had been. In “compound word” exercises, he had seen the same thing he had already figured out – on his own – only now, he was seeing that in some cases, the new words could be “totally unrelated” to the original words. Whether or not that was “a good thing” for him to see, I supposed only time would tell.

Within this was certainly the potential for Zachary to come up with his own new little dictionary of “compound words” that he could make up himself. Thus, there was again, a double-edged sword in this.

The concept of putting words together to form new words absolutely was a critical part to learning language, but, if allowed to go “uncontrolled”, I could certainly see where the “uninhibited formation of compound words” could indeed become a problem.



Zachary had learned and put together “socially acceptable and Webster type compound words” via his education software for quite some time now and I was happy to say that he had not “invented” his own words any more. Of course, I had now moved him to a point where he now knew to ask: “What’s that, mom” if he wanted to know “what something was” and as such, he did not have to come up with his own definition... he came to understand that everything already had a definition – or label - and all he had to do – was ask for it!

The funny thing in all this was that my husband actually found life easier if he made up his own compound words, too. Sometimes, it was truly hilarious to see how things could work so much more smoothly if we just saw the world as Zachary did. This had been especially true in matters relating to putting clothing on Zachary. He hated to keep his blankets on at night. Inevitably, Zachary pretty well always pushed them off while he slept.

During the night, I often checked on him only to find his little feet very cold during the night. As such, I had tried to put socks on Zachary at bedtime. Of course, although he initially let me put them on, by the time he actually went to sleep, the socks were always off and on the floor. My husband finally found the trick to this simple problem. As he prepared Zachary for bed one night, he told Zachary he had to put on his “sleeping socks”. By labeling them as “sleeping socks” Zachary easily accepted the fact that these socks were for sleeping and now, this was no longer an issue. Likewise, I had found I could get Zachary to more easily accept different forms of clothing if I gave them new labels.

I used to always say: “Put your pants on”... to Zachary – that meant “his sweatpants”. When I had tried to put jeans on him, he had resisted. It finally dawned on me when on my in-laws farm that “pants” could have “different names”. So, I did my little test. I attempted to put overalls on Zachary – only this time, I did not call them “pants” but rather “farmer pants”. Sure enough – that made it ok. The label had made all the difference! In the past, Zachary had more issues with touch perception than he now did while on enzymes and that too, could certainly have played a role in this better ability to sense or more easily tolerate various “touches” or sensations.

The following was a list of compound words that could be used to teach the concept of “putting words together to form new ones”..., but, again, **I strongly encouraged parents to make sure their child also understood that everything had its own “label” and that there was no need to “invent a label” on your own.**

Again, the key to doing this was literally my saying to Zachary “what to say” when he needed to understand a label. I told him, “When Zachary does not know what something is, Zachary says... what’s that mom?” and mommy will tell him or a shorter variation such as “If Zachary needs to know something, just say, what’s that, mom?...”. :o)

## Compound Words...

back	+	yard	=	backyard
bath	+	room	=	bathroom
bath	+	tub	=	bath tub
birth	+	day	=	birthday
book	+	mark	=	bookmark
book	+	case	=	bookcase
book	+	keeper	=	bookkeeper
bottle	+	neck	=	bottleneck
car	+	pool	=	carpool
day	+	light	=	daylight
dog	+	house	=	doghouse
down	+	town	=	downtown
ear	+	ring	=	earring
earth	+	quake	=	earthquake
every	+	day	=	everyday
finger	+	print	=	fingerprint
fire	+	man	=	fireman
fire	+	place	=	fireplace
foot	+	print	=	footprint
foot	+	ball	=	football
gold	+	fish	=	goldfish
grass	+	hopper	=	grasshopper
hair	+	clip	=	hairclip
hill	+	top	=	hilltop
house	+	boat	=	houseboat
in	+	side	=	inside
key	+	chain	=	keychain
light	+	house	=	lighthouse
lip	+	stick	=	lipstick
mail	+	man	=	mailman

mail	+	box	=	mailbox
mouse	+	trap	=	mousetrap
my	+	self	=	myself
news	+	paper	=	newspaper
night	+	light	=	nightlight
oat	+	meal	=	oatmeal
out	+	side	=	outside
over	+	all	=	overall
pea	+	nut	=	peanut
pitch	+	fork	=	pitchfork
police	+	man	=	policeman
pop	+	corn	=	popcorn
quick	+	sand	=	quicksand
rail	+	road	=	railroad
sail	+	boat	=	sailboat
sand	+	bar	=	sandbar
sauce	+	pan	=	saucepan
seat	+	belt	=	seatbelt
snow	+	flake	=	snowflake
some	+	day	=	someday
some	+	where	=	somewhere
some	+	time	=	sometime
some	+	body	=	somebody
sun	+	light	=	sunlight
tooth	+	paste	=	toothpaste
trash	+	can	=	trashcan
under	+	ground	=	underground
wall	+	paper	=	wallpaper
water	+	fall	=	waterfall
your	+	self	=	yourself

I had also found that labels helped somewhat with issues with food and/or supplements. For example I had finally come to get Zachary to associate the words “medicine and good for you” so that I could now actually get him to take a bitter supplement with very little difficulty – at least for now. ***As such, “word associations” and their value spanned far, far beyond “just language”. Word associations, I had now found, were key in getting desired behaviors as well. Likewise, they were key in getting rid of undesired behaviors. This all made perfect sense to me given that word associations and motor activities, motor habits and memories tied to motor activities as well as motor planning and execution were all functions co-located in the frontal lobe.***

The best example of this that I could give had to do with potty training. For years now I had associated for Zachary the words “poop in your diaper” each time I had asked him: “did you poop in your diaper”. I had no doubt that this had, at least in part, contributed to his lack of desire to be potty trained. Recently, I had started to say: “you have to poop in the potty” in an attempt to break that old word association of “poop and diaper”. I discuss this issue in much greater detail in both books 2 and 3 for parents who were interested in this particular issue. Word associations, I had found to be invaluable in matters dealing with control of emotions, discipline, and many, many other areas of life. There was simply no denying that this was a critical key to behavior modification in these children. Word associations as they related to the control of emotions and discipline were discussed later in this text.

Clearly, things like “***words to cope***” as described in both book 2 and 3 involved word associations. “Words to cope” were little words or phrases I had noticed had so greatly helped Zachary to overcome frustration in life when things were not working quite the way they should. These included words like “it’s ok... just try again” or “when something doesn’t work... just try again... and again... and again... you’ll get it”, or “don’t get mad... just try again”... or “try a different way”, or “you can do it”, or “if you don’t understand... just say, what’s that or help me”, or “just ask for help”, etc. When “coping words” involved the use of pronouns, such as “you”, I now tried to make Zachary repeat phrases using the proper pronoun. For example, if the coping words were “you can do it...”, I would say, “Zachary, you can do it... Zachary, say: I can do it...” as I literally made him repeat the phrase using the proper pronoun. These simple phrases became absolutely key in our household – especially those phrases that taught Zachary himself how to overcome his stress – those valuable little phrases like “it’s ok... just ask for help”.

As I once again looked at the functions co-located in the frontal lobe along with word associations again, there could simply be no denying that these functions were much more inter-related than we may have ever imagined. As such, I now believed that word associations were key to issues involving not only language production itself, but to matters involving desired or undesired behaviors or motor activities, key to motor planning and execution, key to activity in response to one’s environment (i.e., safety issues), key to memory as it related to habits and other motor activities, key to olfactory functions (i.e., accepting bitter supplement in spite of its nasty taste based on a word association), key to higher functioning (i.e., concept of self, imagination, etc.), and key to the control of emotions. In other words, clearly, word associations appeared to be very much tied to pretty well all other functions found in the frontal lobe.

More important, however was the fact that word associations were a form of categorization. As such, word associations, perhaps more than anything else, provided a critical bridge to functions located in other parts of the brain – such as the temporal lobe – that part of the brain associated with categorizations! Word associations provided the mechanism so critical to building a bridge between language production in the frontal lobe and the understanding of language in the temporal lobe. Furthermore, because word associations provided for that “bridging function”, they also provided a mechanism for accessing “all functions” in the temporal lobe given my theory that co-located functions within a specific part of the brain were much more interrelated than we may have ever imagined. As such, a bridge to the temporal lobe via word associations provided access to auditory processing, olfactory processing, memory acquisition, emotion, voice recognition, face recognition, the ability to distinguish between truth and a lie, visual perception as it related to the face, place and body part recognition in addition to that critical bridge to the understanding of language.

Word associations also helped to explain “routines”. For example, whenever Zachary ate rice spaghetti, it was a given that when he was done he always said: “ice cream, please” in order to get his rice based ice cream. To Zachary, “spaghetti and ice cream” always went together. Thus, again, motor activities, habits, motor planning and execution, word associations and olfactory issues clearly all fit into this simple phrase or word association of “spaghetti and ice cream” – as did control of emotions – another function co-located in the frontal lobe – because, clearly, Zachary could get “upset” if his ice cream was not provided.

I had found the key to that little issue to simply be the substitution of the ice cream for another treat having to do with olfactory functions – any preferred treat could easily be used as a substitute. I had no doubt that this was because the olfactory cortex and control of emotions were co-located and as such, it very much appeared the sense of smell was very, very tied to the control of emotions [more on this issue later in this text]. The point here was that clearly, even though “substitutions” could be made for treats to help with the control of emotions, clearly, word associations such as “spaghetti and ice cream” or “take your zinc... it’s medicine that’s good for you” and their impact in Zachary’s life were very much – undeniable. As such word associations provided a very powerful tool indeed for matters relating to behavior modification, actual language production and so much more!

For example, word associations also provided a bridge to the parietal lobe via the use of words having to do with shapes. Zachary already knew all his shapes... hexagon, pentagon, octagon, trapezoid, parallelogram, heart, circle, square, oval, and on and on and on. Shapes had been one of the first things Zachary had come to understand. Again, this made perfect sense given that children with autism lived “via references”. Shapes were constant – they never changed. A hexagon always had six sides, an octagon, eight, a circle, “no sides”. Shapes were found everywhere in life and that provided in my opinion, a critical bridge to functions in the parietal lobe – functions that included spatial processing, visual attention, touch perception, manipulation of objects, goal directed movement, 3-dimension identification – all things that clearly could involve – shapes! Shapes also provided a bridge to the occipital lobe or visual cortex. Opposites were another great way to bridge several key parts of the brain, as were things like “visual functions” or olfactory functions that were found in various parts of the brain.

Obviously, among the most key of all these was the word association (frontal lobe) and categorization (temporal lobe) bridge. Again, it was important to keep in mind that although “word associations” tended to mean “verbalizations” to most people, word associations, clearly could involve motions (i.e., sign language) and as such, I urged all parents to keep the apparently critical role of motion in mind as it related to issues involving communication in children with autism.

There could be no denying that word associations (verbal or motioned) were absolutely key to helping the child with autism break the code to a great deal in life. However, word associations required something very critical in order to work properly – they required categorization! By definition, word associations were clearly a form or subset of categorization and in my opinion, this was why this bridge – the word association-categorization bridge – was among the most critical of all because within it were the keys to providing “order” in “dis-order” – the keys to breaking the code to everything – from words to emotions and motions - in the life of the child with autism! Absolutely everything in life had to be somehow - categorized - to be useful.

If you looked at the functions in the brain, these included: motor functions, activity in response to one’s environment, memory as it related to habits and other motor activities, language production, control of emotions, word associations, auditory processing, olfactory processing, memories, emotions, understanding of language, voice recognition, face recognition, ability to distinguish between truth and a lie, somatosensory processing, spatial processing, visual attention, touch perception, manipulation of objects, goal directed movement, 3 dimension identification, integration of all sensory input that allowed for the understanding of a single concept, visual processing and on and on and on - all of these things had to somehow be categorized to be useful!

*Much as there could be “physical disorder” in the physical world all about us, so too could there be mental disorder as a result of the inability to properly categorize (a temporal lobe function). Much as it was more difficult to function efficiently and effectively in a physically disordered world, so too was it more difficult to function efficiently and effectively in a mentally disordered world. As such, clearly, categorization was absolutely key to the understanding not only of language but, indeed - of one’s world.*

**I now truly believed that the key to providing “order” was in providing proper links among the various parts of the brain that appeared to have been somehow disconnected by finding those functions that provided for the building of critical bridges via similar functions– functions that were different - but yet had some similarities – and hence, could be used to bridge gaps that previously seemed so insurmountable. As I had stated previously in order to “build bridges” you had to activate as many parts of the brain as possible - at once! As stated in book 3, this was why a computer was truly a medical necessity for children with autism because while on a computer – almost all major functions in the cerebral cortex (the frontal, temporal, parietal and occipital lobes) as well as several other key parts of the brain (i.e., the cerebellum, hippocampus, basal ganglia, amygdale, corpus callosum, midbrain, thalamus, etc. ) were activated! Zachary loved the computer – a tool I suspected had helped him better understand his world by perhaps rebuilding critical bridges that had once been severed.**

## Left Brain... Right Brain... What's The Difference?

Although there were only four lobes in the cerebral cortex, the frontal, temporal, parietal and occipital lobes, each of these lobes was further divided into “left and right” sections. As such, a person had a left frontal lobe and a right frontal lobe, a left temporal lobe and a right temporal lobe, a left parietal lobe and a right parietal lobe, a left occipital lobe, and a right occipital lobe.

Certain critical language and/or communication functions were usually located in a specific part of the brain – either left or right. For example, Wernicke’s area, associated with the understanding of language was located in what was often referred to as the left temporoparietal cortex, whereas Broca’s area, normally associated with the function of speech production, was an area found in the left inferior frontal lobe. Yet, although there were specific regions in the brain associated with specific functions, clearly, the brain had an amazing ability to adapt as evidenced by the fact that when brain trauma occurred, functions could seemingly “relocate” themselves within the brain. Although how the brain accomplished this was not fully understood, this, clearly, was well documented scientifically.

Amazingly, science had confirmed that in some individuals who suffered from a specific type of brain injury known as arteriovenous malformations (AVMs) in the left frontal lobe, believed to occur while still in the womb, when the left frontal lobe was anesthetized, speech production was not impacted as it would be in normal persons and as such, science believed that “speech production functions” in these persons must have somehow “relocated” within the brain. In these same individuals, if the left part of the brain dealing with the understanding of language – Wernicke’s area - was anesthetized, understanding of language was impacted, as it would be in a normal person. Interestingly, researchers found that, in these individuals, those areas activated during language production – as indicated via functional magnetic resonance imaging (fMRI) – were not in the left hemisphere (where language production usually occurred) - but in the right! In addition, a small area in the left hemisphere not usually associated with language production also appeared to be activated in these individuals.

Persons interested in reading more on this amazing subject and the work of Dr. Ronald M. Lazar of Columbia University’s Department of Neurology and his paper entitled Neuropsychological Function And Brain Arteriovenous Malformations: Redefining Eloquence As A Risk For Treatment, published in Neurosurg Focus 11(5): Article 4, 2001, could do so by going to either <http://www.neurosurgery.org/focus/nov01/11-5-4.pdf> or, for the easier to understand version, to <http://www.columbia.edu/cu/news/00/10/brainDamage.html>.

Interestingly, when it came to understanding the brain, the whole issue of left verses right certainly appeared to add an extra “twist” for scientists – especially when functions seemingly “relocated” in patients who were known to have brain injury. The issue of the “left brain” verses the “right brain” certainly also had significant implications in the study of autism. In a normal brain, incoming sensory input and control of the body appeared to usually “cross over”. As such, the “left brain” for example, was involved in the processing of sensory input and control of the right side of the body and vice versa. There had been a great deal of research into the “right” verses “left” brain and how dominance of one side appeared to impact the type of

person we were. In addition, researchers agreed that there appeared to be gender differences in “right brain” and “left brain” dominance.

For example, according to work done by researchers at the State University of New York at Buffalo School of Medicine, ***males were believed to scan faces with the right brain, whereas females were believed to scan faces with the left brain.*** [source: D.E. Everhart, J.L. Shucard, T. Quatrin, D.W. Shucard, "Sex-Related Differences in Event-Related Potentials, Face Recognition, and Facial Affect Processing in Prepubertal Children," *Neuropsychology*, 2001, Vol. 15, No. 3, 329–341, <http://unisci.com/stories/20013/0709014.htm>].

Given that the left-brain attended to “the whole” whereas the right brain attended to “details”, perhaps this could explain why my son Zachary had such a difficult time with “looking me in the face”. In my second book, *Breaking The Code To Remove The Shackles Of Autism: When The Parts Are Not Understood And The Whole Is Lost!*, I had stated that it appeared to me that in order for the child with autism to understand “the whole”, he had to first understand “the parts” that made up “the whole”. As such, if faces were scanned by the “right brain” in boys, it certainly appeared that this was at least in part, an explanation for what I was seeing in my son. ***If Zachary needed to understand first “the parts” to understand “the whole”, it would make sense that he would have difficulty with faces if they were processed as “wholes” and not “parts”.*** This whole issue of “left brain” verses “right brain” certainly was an interesting one when it came to understanding children with autism. The following table as it related to “left brain” verses “right brain” was based on work done N. Geschwind, entitled *Specializations Of The Human Brain*, published in *Scientific American*, 241, 180-199 in 1979.

<b><i>Left Brain</i></b>	<b><i>Right Brain</i></b>
Verbal	Nonverbal
Intellect	Intuition
Analytical	Holistic
Convergent	Divergent
Intellectual	Sensuous
Serial	Parallel
Focal	Diffuse
Deductive	Imaginative
Active	Receptive
Discrete	Continuous
Abstract	Concrete
Algebraic	Geometric
Propositional	Oppositional
Propositional	Affective
Realistic	Impulsive
Transformational	Associative
Lineal	Nonlinear
Historical	Timeless
Explicit	Tacit
Objective	Subjective
Activation	Arousal

I had found this table relating to Geschwind’s work on the website of Macquarie University (Sidney, Australia) Department of Linguistics. This website provided a good, easy to understand basic overview entitled “Neuroanatomy and Neurophysiology of Speech and Language” and was available at <http://www.ling.mq.edu.au/units/sph302/neuroling/>.

A little more research on the Internet provided more still. Other words I had come to understand as being associated with either left or right included:

<b><i>Left Brain</i></b>	<b><i>Right Brain</i></b>
Logical	Random
Sequential	Intuitive
<b><i>Focus on parts</i></b>	<b><i>Focus on whole</i></b>
Analytical	Synthesizing
Rational	Holistic
Reality based	Fantasy oriented
Symbolic	Concrete
Respond to meaning of words	Respond to tone of voice
Respond to logic	Respond to emotion
Respects rules, regulations, deadlines	Less attentive to rules, regulations, deadlines
Greater ability to distinguish between right and wrong	Less able to distinguish between right and wrong
More aware of time	Less aware of time
Plans ahead	Impulsive
Better with names	Better with faces
Less social	More social
Use few motions to speak	Use motions to speak
Punctual	Less punctual
Prefers more formal study atmosphere	Prefers sound or music in background while studying
Prefers good lighting when studying	Prefers to move around when studying
Order focused	Less order focused
Auditory receptive	Able to tell if someone is lying or joking
Specializes in words, reading, writing (agreed upon rules)	Specializes in music, art, visual-spatial, visual-motor functions (more creative)

Again, from the Macquarie University Department of Linguistics website, under a section entitled “Sex, Brain and Language”, the following comment was found:

***“Springer and Deutsh (1981) discuss evidence for language related sex differences in brain function. There is some evidence that females have a more bilateral (across the two hemispheres) distribution of language functions than males. [end of quote, R. Mannell, Dept. of Linguistics, Macquarie University, <http://www.ling.mq.edu.au/units/sph302/neuroling/>].***

And finally, this quote, regarding lesions to the thalamus, from the same Macquarie University website – I quote:



***“Damage here results in verbal fluency and word repetition problems. The thalamus appear to be involved in directing attention to verbal input, in retrieving information from verbal memory and to play some role in the regulation of the activity of speech production muscle activity.” [end of quote R. Mannell, Dept. of Linguistics, Macquarie University, <http://www.ling.mq.edu.au/units/sph302/neuroling/>].***

I had, again, found this very interesting given the thalamus was also known to be involved in matters relating to “the conscious” and “subconscious”. Interestingly, the one sense that could bypass the thalamus was the sense of smell! Note that the sense of smell was also the only sense co-located in the frontal lobe along with “language production” functions. Yet, clearly, the above quote indicated that the thalamus was somehow with speech muscles. Motor functions were also known to be located in the frontal lobe – along with language production and smell, but they were very much “coordinated” by the cerebellum – the very part of the brain so often shown to be much smaller in children with autism in MRIs – the cerebellum – the very part of the brain now believed by Dr. Jay Geidd to take well over twenty years (20) to mature and hence, believed to be more impacted by “environmental factors”. Could those environmental factors include things like mercury, aluminum, iron, and/or viruses? In my opinion, that certainly seemed to be a possibility – especially given the Simpsonwood meeting transcript indicated that developing or immature cells appeared to be the most “susceptible” to mercury injury.

Certainly, the case could be made that if the cerebellum took over twenty (20) years to mature that, at birth, or in a child, this part of the brain certainly had to be among the most immature of the immature cells found in the brain.

As I neared the completion of this book, an article by Geoffrey Cowley had appeared in the September 8<sup>th</sup>, 2003 edition of Newsweek entitled Girls, Boys and Autism. In this article, the researchers appeared to be arguing that autism was nothing more than a different style of learning and that there might be a “left brain dominance gene” that might help explained autism. Honestly, I could not help but laugh and cry as I read the article. It was, in my opinion, yet another article in a major publication that simply showed how the author, truly, did not understand the many faces of autism and I believed that this article did more harm than good in trying to help the general public understand “autism”. Particularly troubling for most parents was perhaps the following quote from this article in the September 8<sup>th</sup>, 2003 Newsweek article:

***“If Baron-Cohen is right, autism is not just a disease in need of a cure. It's a mental style that people can learn to accommodate. Sometimes it's even a gift.” [end of quote, Geoffrey Cowley, Girls, Boys, and Autism, Newsweek, September 8<sup>th</sup>, 2003].***

A gift?

I could only suggest that Baron-Cohen spend a week or so with the parents and children who had been so devastated by autism. Perhaps that term “gift” would then be changed to a more appropriate word so many parents of children with autism feel they suffer along with their children – “an imprisonment” - because, all too common was the very real fact that the life of not only the child, but of the entire family was stolen by “autism”.

The other very obvious reason that “I did not buy this theory” had to do with the comments made to the effect that this “research” helped explain sensitivities in terms of sensory input – light, sight, sound, touch sensitivity, etc. in children with autism.

The simple fact was that I knew that casein (milk protein) and gluten (grain proteins) were known to act as hallucinogens on the brain of children with autism. When I changed Zachary’s diet, and then, later added enzymes to help break down trace amounts of casein and gluten from hidden sources I may have missed, Zachary’s light, sight, sound and touch sensitivities were greatly reduced. If this “theory” were true, that should not be the case. A change in diet should not change sensory sensitivity and yet, I knew of hundreds of families who had changed the diets of their children and had experienced the same thing I had seen in my son. This had also been the case for families who had engaged in chelation therapy – a process whereby metals were removed from the body. Persons wanting to learn more about that could visit the enzymes and autism or autism and mercury Yahoo groups online at:

<http://groups.yahoo.com/group/EnzymesandAutism/>

and

<http://groups.yahoo.com/group/Autism-Mercury/>

There were plenty of parents on these discussion boards who would attest to these facts.

I, personally, thought Baron-Cohen needed to “go back to the drawing board” – in a “major” kind of way! :o)

It has obviously been known for quite some time that there are gender differences in how boys and girls process information, however, that was true of all boys and girls – not just those with autism – and to suggest that “left brain dominance” was related to some kind of a gene that made one more susceptible to autism was in my opinion, simply ludicrous. The differences in left-brain versus right brain dominance have been known for quite some time – as evidenced by the fact that Gerchwind’s work was published in 1979 – close to thirty five (35) years ago. Yet, the fact remained that the explosion in autism was a fairly recent phenomenon and as such, in my opinion, the “left brain” vs “right brain” dominance theory could not possibly be used in explaining the “cause” of autism.

It was also interesting that the Macquire University Department of Linguistics article also stated that brain asymmetry appeared to very much be a function of left or right handedness. How interesting indeed!

I had no doubt that the brain formed more neurons I “the dominant side”. Now, however, more than ever, I questioned many of those studies on brain asymmetry and autism – I still did not know if my son was right or left handed – he did some tasks with one hand, and other tasks with the other.

So, if handedness also played a role in those parts of the brain dealing with language, how did all this fit into “all those studies” on autism and brain asymmetry? It seemed to me that there could be a few “confounding variables” not being taken into consideration in some of those MRI scans or studies stating that “brain asymmetry” was a problem in children with autism.

How did we know that the brain asymmetry seen in these children was not simply the brain “adapting” to compensate for injuries sustained, a brain developing “more neurons” in those areas that worked best in an attempt to “break the code”? In my opinion, brain asymmetry, in and of itself was not necessarily “a bad thing”. It seemed to me that indeed, perhaps the brain had been “designed” to work this way and provided for man a way to somehow adapt to or cope with a brain injury.

Indeed, there certainly appeared to be many “backup systems” in the human body. We had two eyes, two ears, two hands, two arms, two feet, two legs, two kidneys, two ovaries or testicles, two sides to the heart, two lungs... and two parts to the brain... and in all of these, if one part failed, the other was there to help “take over” or assume functions no longer being performed by the “damaged part”. Why should the brain be any different than any other part of the body? Could “asymmetry” in the brain of children with autism not simply be testimony to the marvelous creation that was man himself – especially when it came to – the human brain!

As the mother of a child with autism, I simply did not see brain asymmetry as “a bad thing” and suspected it may actually be just the opposite – a good thing. Of course I was no doctor or neurologist – these were only my opinions!

Certainly, the fact that boys were known to be more left-brain dominant and girls were believed to be more right brain dominant helped us to explain what we saw in these children – but, it certainly did not provide a “cause” for autism. As such, again, I felt Baron-Cohen certainly did need to “go back to the drawing board” – in a “major” kind of way! Based on what I had seen in my son, and the research I had done – as a mother - there assumptions and conclusions had been very much “off base. Funny how there just seemed to be so many studies that stated “autism” was a “gene problem” and yet, no “gene” had been identified for this tremendous impairment of the brain. It just seemed to me that if “a bad gene” was behind all of this – we would have found it by now – because, certainly, something that caused “so much damage” should be fairly obvious as a “mutation”. It just seemed that such a critical mutation would have long ago been identified given all the bright scientists out there.

I guess the best thing I could suggest to those scientists was to read the Simpsonwood transcript and also view that University of Calgary video – perhaps then, the real issues with autism would start to fall a little more “into focus”. We just had too many of these studies I now viewed as “nice try... but now cigar... parents were no longer that naïve!” :o)

In both my second and third books, I had explained how, in my opinion, I could explain almost everything I saw in my son if I assumed little or no communication among the various parts of the brain. I also believed that because of what appeared to be lack of communication among the various parts of the brain, it also seemed as though those functions co-located within a specific

part of the brain (i.e., functions within the temporal lobe, etc.) appeared to have magnified communication.

Thus, if my theory were correct, it would make sense that given boys were more “left brain focused”, that these functions would be “more magnified” in the child with autism. Thus, in my opinion, the “left vs right brain dominance theory” helped us to understand what we saw in these children, but it certainly did not provide a “cause” for autism.

As I had stated on so many occasions, it appeared to me that my son perceived the world in “bits and pieces” and that he had to understand “the parts” in order to understand “the whole”. Given the brain structure and function, the theory of little or no communication among the various parts of the brain certainly supported this reasoning. For example, the olfactory cortex and motor functions were found in the frontal lobe. Auditory processing and olfactory processing were found in the temporal lobe. Touch perception was found in the parietal lobe. Visual processing was found in the occipital lobe. As such, sensory input entered the brain in different parts of the brain, and if there was limited or no communication among the various parts of the brain, then, Zachary’s world – his sensory input – could certainly be perceived as “bits and pieces” that he would then have to painstakingly “put together” – consciously - in order to understand the whole.

Note that the integration of sensory input to perceive a single concept was a function located in the parietal lobe. The integration of central nervous system (brain and spinal cord) and peripheral nervous system (everything else) was a function located in the thalamus. Thus, if input was not flowing properly to these areas due to lack of neural connectivity, surely, one’s world could certainly be perceived as “bits and pieces” that did not appear to fit together properly, and hence, the title of my second book - *Breaking The Code To Remove The Shackles Of Autism: When The Parts Are Not Understood And The Whole Is Lost!* This issue was also discussed in my third book – *Breaking The Code: Putting Pieces In Place!* I encouraged all parents to read both of these books in order to better understand why it was that I came to understand those things I did in my son and why I became convinced that the underlying issues in children with autism had to do with severed neural connections that had to somehow be rebuilt – connections that would help the “left” and “right” brain work together in a more efficient and effective manner.

As I looked at these various words used to describe “left brain” or “right brain” dominance, although there obviously were some things that indicated Zachary had “dominance” for certain things on the “right side”, clearly, in looking at this list, my son was “left brain focused”.

As such parents had to have an understanding of the “dominant” side of their child in order to best help that child learn. The “cookie cutter” one method for all simply could not be used for children with autism. Clearly, some children could be more “right brain” focused while others – like Zachary, and I suspected most boys – could be more “left brain” focused. Likewise, I very much suspected girls were more “right brain dominant”. As such, perhaps the key to helping these children was to also consider materials for either “left” or “right” dominant focused children.

These children had so many challenges to face that it was in working with their strengths that they could best be helped to begin to decode their world. As more of the “code to life” was broken it would then be easier for these children to come to use “less dominant” functions in order to come to an even greater understanding of their world. I just felt that to use those things that were “less dominant” or “weaker areas” in a child would not be as effective as using those functions in which a child was known to be “strong or dominant”. In my opinion, to reach a child with autism, you had to make things as easy as possible initially, and then, as the child began to communicate and understand his world, you could then go from there to strengthen areas of greater weakness.

As I looked at this list to describe “left brain” vs “right brain”, clearly, although Zachary was more “left brain” focused in my opinion, there were some things that were critical in which he clearly was more “right brain focused”. For example, the fact that Zachary loved seeing me use “signs” or “motions” for language told me that in this particular aspect, he was more “right brain focused” when it came to language. Also, if given a choice, I knew Zachary preferred to have soft music playing while he also worked on the computer, again, indicating more strength in this particular function on the right side of the brain. The one thing that certainly “stood out” as I looked at all this information, however, was the fact that Zachary - overwhelmingly – had left brain dominance. Very, very few things on the “right side” applied to Zachary – yet, the critical one having to do with language, again, was that involving motion in speech – of that – there was absolutely no doubt in my mind! Surely the fact that the “left brain” was so dominant in Zachary had to impact the numbers of neural connections and hence, neural growth, in very specific parts of the brain – and thus, brain asymmetry.

One could certainly get lost in “all those brain studies”, however, my point here was simply to raise the issue that there were many factors that played into brain asymmetry – including things like left or right handedness – things that in and of themselves, appeared to have very little to do with autism in and of itself. Certainly, these factors had to be considered, however, in looking at issues of brain asymmetry and left or right brain dominance. As such, I encouraged all parents to be cautious of studies on brain asymmetry to ensure that such variables had been taken into consideration. There were many, many other issues pertaining to “brain studies” I felt parents should be aware of. These had been provided in my second book – in a section entitled, “All Those Brain Studies... What Do They Really Tell Us?”.

As I thought about so many issues relating to autism, clearly, there was simply no denying that Zachary, indeed, was very much “left brain dominant”. Without a doubt, he was very much a boy that thrived on rules!

Zachary’s tremendous need for having things “fit together properly” when it came to language was clearly evident in something he had asked me to do lately. As I made my bed one morning, Zachary was near the window, looking outside as he recited his alphabet – something he still liked to do now and then. On this particular occasion, however, he realized there was something that was “not quite right” when it came to the alphabet and how it worked.

When Zachary got to the letter “w”, he hesitated and said: “mom, spell w... starts with a – “d”...”. Of course, I knew right away what the issue was. Before I answered, even though I

knew myself to be more of a “right brain” person and as such, more impulsive, I knew that for “this answer”, I had to think a little more before I responded.

I could not simply spell “w” as “w”... because clearly, Zachary had picked up on the fact that “w” had a sound that started with a “d”. As such, I said: “double equals 2, “w” equals 2 “v’s” or 2 “u’s” put together... w... “d-o-u-b-l-e” spells “double” ... double... u... the letter has a sound like a “u”, but it looks like a “v + v... 2 “v’s” together...” but it says “wuh”.... And there I had it, the spelling for “w”... only in spelling “w”, I had to provide a “spelling” to match the fact that it started with a “d”, a “sound” for the letter itself that “sounded” like a “u”, a “look” that “looked” like a “double v”... and the phonics for a letter that said “wuh”!

Only “w”, “y” and “h” were letters of the alphabet for which the phonics were very different than the letter as it would be recited in the alphabet. Zachary had not yet picked up on the fact that the letter “y” was also an “oddball letter” because that letter, when recited as part of the alphabet, had a name with a sound that started with the sound for “w”... “wuh”. Likewise he had not picked up on the fact that “h” really sounded like a letter starting with an “a + ch” sound.

All other letters were recited or “named” in the alphabet in a way that very much matched the actual phonics for that letter. Certainly, there were a few very subtle differences, but, they were so subtle, that Zachary had really not noticed them – at least not yet!

Of course, when I finished giving Zachary “the spelling of – w”, I also made it a point to tell him this was a “mixed up letter”. He had a good understanding of what “mixed up” meant and so he found it very funny when I told him, “w is such a mixed up letter... it’s so silly...”. This little example had clearly showed me that for Zachary, rules were very important - as were sounds – in the understanding of language!

As I thought about this, I could not help but wonder who the genius was that had named a letter that looked like “2 v’s” stuck together a “double u”. I thought, surely, he could have called it at least a “double v”. But, then, I soon realized that in writing this letter, it was often written in a “curved” manner so that it could actually look like either two “v’s” or two “u’s” stuck together. As such, I decided to add a little more to the spelling of “w” for Zachary – only this additional explanation involved motion to help him understand the issue. As I explained “double equals 2” and said “double u” equals “2 u’s” or 2 v’s”, I literally motioned the formation of “2 u’s together” in the air to form “w” in a “curved” way and then did the same thing to show “2 v’s” as I showed Zachary it could be either one or the other.

Having gone through this little “spell w” exercise made me think that, perhaps, we should rename this letter - “wobble u” or “wobble v”. :o)

Who would ever have thought that “spell w” could be so complicated! Yet, clearly, Zachary, a very “left brain” child, needed “an entire explanation” for this very odd letter... one of only a few letters that obviously had a sound that did not match the “recited or named alphabet letter”.

Although there was still disagreement on this issue, it seemed many in science were indicating that boys were indeed generally more “left brain focused” than were girls and that girls were

more “right brain focused”. If that were true, it certainly had some rather interesting implications. For example, if one was more “creative” or “right brain dominant”, as opposed to “left brain dominant”, did that not mean that persons who were “right brain dominant” would have a better ability to “think for themselves” whereas those who were “left brain focused” would be more dependent on “rules” or things they had been taught? This certainly made me chuckle given the fact I constantly joked and reminded my husband of the fact that God did not see his creation as “just right” until after he had created woman – that partner in life who provided “balance” for man and was always *more than happy* (that would be the emotional side to woman) to provide input (that would be the creative side to woman) to allow “man” see things in a whole new light. :o)

Again... all very interesting... and a little funny... indeed! As I considered all this, I also could not help but think about how all this related to functions that were co-located within specific parts of the brain. For example, language production and motor activity were co-located in the frontal lobe. Zachary, clearly a “left brain dominant” child still clearly was absolutely impacted by the use of motions in language production and the understanding of language. As I had stated earlier, he absolutely loved anything that had to do with motion in communication, whether that was in teaching him new words or in communication as play or some other activity.

For example, if my husband rubbed his hands together in anticipation of “going after Zachary to catch him”, Zachary became very, very excited and just loved that “motion” on the part of my husband as he played with Zachary. So many of these “small things” I never would have noticed before now leaped out at me as I considered the area of communication and how Zachary reacted to various forms of communication – written, verbal/auditory, sight, motion. Of these, clearly motion involving the hands and auditory forms of communication were those that most impacted Zachary as we worked with him.

Given production of language was co-located with motion in the frontal lobe and auditory processing was co-located in the temporal lobe along with the understanding of language, of course, that made sense. It also made sense to me that communication involving the perception of body parts (i.e., sign language or motion of the hands) would help with the understanding of language given that function (perception of body parts) was also in the temporal lobe. This also certainly helped explain why “body language” helped with the understanding of language or could be such a powerful means of non-verbal communication. Likewise, the recognition of faces was located in the temporal lobe and memory related to the recognition of faces was in the right temporal lobe. Thus, again, given the understanding of language was in the temporal lobe, did it not make sense that we best understood those we recognized and did it not make sense that our “socialization” functions as they related to others would “work best” when interacting with those we recognized – such as family members and/or friends.

There was no denying that the study of language as it related to language production and comprehension was very interesting indeed when one considered the many, many variables that played into “communication” – motor activity, muscle functions, emotions, smells, tastes, touch, body language and/or other visual cues, memories, imagination, and possibly conscious and/or subconscious communication, etc. Human communication certainly was fascinating to say the least!

## Mystery... In The Right Temporal Lobe...

The area of “communication” certainly was a fascinating area of study. Perhaps one of the most fascinating of all aspects of communication, at least in my opinion, had to do with what I now referred to as “the mystery... in the right temporal lobe”.

The following was the “mystery in the right temporal lobe”:

**Right temporal lobe damage was known to result in “incessant speech”. The “mystery” in this was that the right temporal lobe was not a part of the brain associated with “speech production”! As such, how could a part of the brain not normally associated with “speech production” – the actual verbalization of speech – result in “incessant speech” when this part of the brain was damaged?**

Note that “incessant speech” appeared to imply “a lot of speech”. The medical community had well documented the fact that it appeared some functions could “relocate” themselves somewhat when there was brain damage. But, obviously, this could not be a case of “relocation” of the “speech production function” that normally resided in the frontal lobe. It was “temporal lobe” damage that resulted in “incessant speech”... not frontal lobe damage. As such, damage to the temporal lobe alone appeared to be enough to produce “incessant speech”. That certainly appeared to mean that “frontal lobe damage” and “relocation of the speech production function” to the temporal lobe was not the issue. Even if the relocation of speech production from the frontal lobe to the temporal lobe could be at play, how could it be that this relocation would result in “incessant speech”? Usually, when functions appeared to relocate, they did not do so to the point that you had “more of that function” than you originally had previously. When the brain “adapted” and appeared to relocate functions, they were only “reappearing” in very limited capacity. And again, “incessant speech” certainly appeared to imply – “a lot of speech” – not just “a little”.

**Broca’s area**, an area in the **left frontal lobe**, was usually considered the “**language production area**” in man. Wernicke’s area, in the **left temporal lobe**, was considered that part of the brain involved in the understanding of language. The left temporal lobe was also associated with memories for words, etc. The right temporal lobe, however, was not associated with “speech production functions”. Memories in the right temporal lobe also did not have to do with “words” but rather with memories as they related to faces, etc. Thus, again, how was it that an area of the brain, associated with neither the production of language nor the understanding of language – could result in “incessant speech” when damage occurred in the right temporal lobe? An interesting mystery indeed!

Note also the work of Dr. Ronald M. Lazar of Columbia University’s Department of Neurology and his paper entitled *Neuropsychological Function And Brain Arteriovenous Malformations: Redefining Eloquence As A Risk For Treatment*, published in *Neurosurg Focus* 11(5): Article 4, 2001.

Per his findings, When the frontal lobe of in some individuals who suffered from a specific type of brain injury known as arteriovenous malformations (AVMs) in the left frontal lobe, believed



to occur while still in the womb, ***when the left frontal lobe was anesthetized, speech production was not impacted as it would be in normal persons*** and as such, science believed that “speech production functions” in these persons must have somehow “relocated” within the brain. In these same AVM individuals, if the left part of the brain dealing with the understanding of language – Wernicke’s area - was anesthetized, understanding of language was impacted, as it would be in a normal person. ***Interestingly, researchers found that, in these individuals, those areas activated during language production – as indicated via functional magnetic resonance imaging (fMRI) – were not in the left hemisphere (where language production usually occurred) - but in the right! – First Clue!***

Thus, if anesthetized, in the frontal lobe area usually associated with “speech production” – Broca’s area – the speech of these individuals was not impacted! Hum. Very interesting!

Science has long known that there was tremendous “cross-over” in the brain. In other words, the left part of the brain controlled the right side and the right part of the brain controlled the left. – ***Second Clue!***

What I saw as the “***Third Clue***” to this mystery involved anesthesia, secretin and children with autism! I had started to “suspect” what I now believed to be perhaps part of the answer to the “mystery in the right temporal lobe” when I had written my second book, *Breaking The Code To Remove The Shackles Of Autism: When The Parts Are Not Understood And The Whole Is Lost!*

Below was a replication of a section written in my second book that in my opinion, clearly played into the “mystery of the right temporal lobe”. This was a rather long section, but it was well worth the read, because in my opinion, this had major implications for the production of language in children with autism and appeared to possibly hold the keys to unlocking the “mystery in the right temporal lobe”.

***Start of Excerpt From Breaking The Code To Remove The Shackles Of Autism: When The Parts Are Not Understood And The Whole Is Lost! (taken from a book I had previously written - book 2)***

“As I rested there a thought came into my mind. This thought had to do with the subject of anesthesia and the autistic child.

My sister-in-law had read a great many books on autism and spoken to many persons about her son’s issues over the many years she had dealt with this disorder. Her son Andrew was now 11 years old. Christine had long ago told me of the “secretin story”. She had heard someone else basically say that secretin, an enzyme occurring naturally in the body, had come to be viewed as a potential option for the autistic based upon something that had happened to a woman and her autistic son, who had surgery!

As Christine relayed this story to me, sketchy as it was, she basically said “this woman” had an autistic son who was nonverbal, that he went in for surgery and “came out talking”. She went

on to explain that the mother, baffled by this had asked the doctors what they had done to her son – because he had “gone in” nonverbal yet “came out” talking. Christine then explained how the mother was told the son had been given an injection of secretin. And, here started the “secretin treatment option”.

From what I knew of secretin, pretty well everything indicated it was a very unproven therapy. As I wondered “why” results varied so much, my thoughts suddenly went to thoughts about anesthesia. I wondered why thoughts of “anesthesia” would enter my mind at this particular time... as I wondered about “secretin”. How could anesthesia and secretin be related, I wondered. I thought about that and within 15 minutes, I came to another theory in terms of this “nonverbal child becoming verbal”... **perhaps the thing that had caused the child to speak was not the secretin, but the anesthesia!**

**Secretin, given that it was an enzyme occurring naturally within the body, may have helped address, not the issues of speech, but rather the natural opiate effect of casein and gluten in the autistic child... or simply helped with better digestion. This certainly could explain why secretin had such inconclusive results in terms of autistic children. Some autistic children were c/f while others were not! This enzyme, secretin, was secreted at a very specific time during the digestive process to neutralize stomach acid. This enzyme was very much involved in digestion – that fact was certain - but how did that translate to a role in language production? I simply did not see that the two – secretin and language production - “went together”.**

Zachary had been on digestive enzymes to break down foods and prevent the natural opiate effect of casein and gluten for over 6 months now. Yet, Zachary’s language production had not really been impacted by enzyme supplements. I suspected that secretin, also an enzyme, could have had some impact in autistic children in neutralizing the natural opiate effect of casein and gluten, but, again, I just did not see how it could have impacted language production. Secretin, from everything I had seen, was a rather expensive option in comparison to the enzymes I used with Zachary. Parents on message discussion boards seemed to indicate that the cost of secretin varied greatly... some saying it was as low as \$45.00 per injection, others saying as high as several hundred dollars. If indeed, the effect of secretin was in that it was an enzyme and that its impact was really not one impacting speech development, but rather only one of addressing the natural opiate effect of children, then parents certainly had more affordable options.

**In my opinion, the fact that secretin was an aid in digestive processes, certainly made sense in terms of my theory given that digestive functions were controlled within the brain stem – the only truly functioning area during the child’s procedure while under general anesthesia, and as such, secretin, a digestive enzyme, would have been allowed to “do its thing” even under anesthesia!**

I wondered about whether or not the effect of secretin could have somehow been tied to a “more focused digestive process” during this child’s operation as a result of the numbing of the senses and thus, the fact that perhaps the body “reacted better” to the secretin and had somehow triggered the language. But, again, this could not have explained the generation of speech in this child – certainly not for any length of time. From what I knew of enzymes and how they

worked, they were produced by the body and basically “used up” in digestion. They were not something that could be “stored” or used later. They acted on the foods at the specific time they were needed within the digestive process... and that was pretty well it. So, based on the functioning of enzymes, in general, there could be no long term effects based on secretin alone. Secretin could have only helped this child in matters relating to digestion (i.e., in eliminating the natural opiate effect of casein and gluten). Victoria Beck, the mother of this autistic child who had undergone an endoscopy, herself admitted that the changes in her child as a result of “secretin therapy” were over a two-year period. Although Zachary had not undergone secretin therapy, in the last two years, he too had made significant strides – strides I greatly attributed to his cdfg diet. Victoria Beck seemed to indicate that the initial secretin infusion for her son had been done by intravenous (IV). Secretin was known to stimulate the secretion of bile, the release of insulin, etc. But, again, these were digestive processes and, as such, yes simply in helping with digestive issues, the autistic child could do much better. But, I simply did not understand or see how secretin could be tied to language production – a function within the frontal lobe – where there clearly existed no functions tied to digestion.

Zachary had been on TMG for close to two years. This was a supplement made by Kirkman Labs, a company that specialized in supplements for the autistic. Although I suspected this product had initially helped produce speech in Zachary, in our experience, once we **removed** the TMG, conversation in Zachary began to flourish. This had always puzzled me. Had this simply been a fluke? A coincidence? I had no way of knowing! I knew B12 and folate were both in TMG. Science had shown that low levels of B12 or folate could actually increase one’s risk of losing hearing when older. Low B12 was also believed to lead to speech delays and permanent nerve damage if the B12 deficiencies were not corrected. Yet, enzymes, such as secretin, were not something you could “accumulate in the body”. Enzymes worked on the foods as they went through the digestive track. A person undergoing an endoscopy would most likely have very little food in the digestive system since substances to “clean out” the digestive track would most likely have been given prior to the procedure. Thus, again, I simply did not see how secretin and possibly “additional B12” [in the case of Zachary], could have been “the answer” as to what caused increased speech in this child.

**As I thought about this situation, I realized that anyone undergoing an endoscopy would likely have had some kind of anesthesia or sedation procedure to alleviate pain. Although I had no way of knowing the type of sedation given to this child, I truly wondered if the anesthesia or sedation could have somehow played a role. In my totally non-medical opinion, anesthesia gases or the smell of sedatives could be a likely explanation for the actual production of speech.**

**Gases or sedation liquids had a smell to them – some rather strong - and the olfactory cortex was in the frontal lobe... the area responsible for speech production... and it was a known fact that the autistic were more difficult to sedate than “normal” children. I wondered if stronger sedatives were used with the autistic... or sedatives that somehow impacted the brain differently than most sedatives/anesthetics.**

If you looked at the brain’s structure and function, it almost seemed to make no sense in certain cases. Why were specific functions not “grouped” into one area... and why was it that things

like the sense of smell were grouped with motor functions and the production of speech, but visual and auditory processing were not? This was all very puzzling to me.

The structure and functions within the various lobes had to be somehow related... in other words, those things that went together, had to be there for a reason – even though, to me, initially, they appeared to make little sense in terms of “how things were scattered” in terms of structure and function. Thus, the olfactory cortex, I thought, simply had to be somehow “grouped with” speech production in the frontal lobe for a reason. If “things” within a specific area were together, and indeed, somehow related, then, if viewed that way, a lot of things did make sense!

The olfactory cortex, for example, was grouped in the frontal lobe, along with motor functions and language production. Anesthetic gas and other sedatives had a smell to them. If I ever tried to introduce new foods to Zachary, as soon as he smelled them, he ran off, literally! He did not simply, shy away or say, “no”, he literally **RAN** off – a motor response! Smell, I now believed, actually triggered motor activity to a large extent!

I knew that if I breathed in helium that somehow impacted my voice (i.e., talking funny)... the production of language – also in the frontal lobe! Helium, I believed, impacted the vibration – or motion - of the vocal cords. Interesting indeed!

**Taking all these factors together, the sense of smell, motor activity, and language production, I wondered if the sense of smell actually did belong with motor activity and speech production in that it literally - triggered it!**

**If that was the case, could I assume that the location of the senses actually triggered the activity within each respective lobe? I now believed this to could indeed be the case!**

If, indeed, this child who had undergone a medical procedure had come out talking, perhaps it had been due not to the secretin, but to the gas(es) or the smell of liquids used in anesthesia or prior to anesthesia. Pre-medication of patients (oral, nasal or rectal) was often done prior to actual intravenous conscious sedation or anesthesia. Given this child was autistic, I can only suspect the procedure had been done under general anesthesia, but I had absolutely no way of verifying that. A local anesthetic only may have been used. Usually, however, conscious sedation was done in order to allow the patient to respond to basic commands or instructions. I did not believe that an autistic child, especially an autistic child who was very limited verbally, would have necessarily benefited the doctors by remaining somewhat awake during the procedure. **My guess** was that this child had most likely undergone general anesthesia... although this was only a guess on my part. From what I could find on this matter on the Internet, the interview of Victoria Beck by Dateline NBC did show that she asked about everything that had been done to her son... including the dose of anesthesia, but that she felt perhaps the secretin had caused the change in her son – a little boy who had barely spoken in two years was now reading flashcards and using words he had not really used before.

If as I suspected this child had undergone anesthesia – as appeared to be the case given the mother’s comments – I truly believed that anesthesia, not secretin, could have been a much more

likely and probably explanation for the production of speech in this child. As I thought of this particular boy, I then began to think of other autistic children whom I knew to have also undergone anesthesia.

My nephew, Andrew, had been born with a heart condition and as such, he had undergone heart surgery at a very, very young age. As such, Andrew, also had undergone anesthesia – and Andrew, at age 11, now spoke “incessantly”.

### **Persistent talking was an indication of damage to the right part of the temporal lobe!**

As with everything in autism, it was always a matter of “degrees” – of “how much” one did something, at least in my eyes.

As I thought a little further about anesthesia and its possible role in autism, I could not help but remember another child, now a young man, approximately 30 years old, who, although not diagnosed as autistic when he was a child now also very much fit into this picture. This young man, although never diagnosed as autistic, had indeed exhibited, throughout his life, the uncanny ability to remember countless facts, had difficulty with social interaction and so on. Since this young man was very, very ill, in order to maintain his privacy, I would simply refer to him as Patrick, although this was not his name. I had always believed Patrick could certainly have been an undiagnosed case of autism – but there was much more about Patrick that now made me wonder about a lot of things – especially in relation to this issue of temporal lobe damage, incessant talking and the possible role of anesthesia!

Patrick had been born with serious kidney problems. He had been ill all of his life and had undergone several operations – including two failed kidney transplants! At approximately 30 years of age, Patrick could now no longer “take in” more than a cup or less of fluid per day. He was constantly exhausted and it took very little, physically, to drain him totally. He only had a very small part of one kidney working. Needless to say, he was a very, very ill young man and he was constantly undergoing dialysis. Indeed, the life of his parents had completely revolved around their son and his dialysis.

As I thought about these three children – my son Zachary, my nephew Andrew and this other child, Patrick - and their common characteristics, the possible role of anesthesia in their lives, troubled me!

Zachary, my own son, had undergone general anesthesia for a broken arm at the age of four. He had fallen off a table and had broken both bones in his left arm. Zachary had only been under the influence of general anesthesia for 15 minutes or so. Although I had wanted to go with local anesthesia only, the surgeon had insisted that for Zachary, he should be put “completely under” – that for young children like this, it “was best to put them under”. He felt this was more so true given Zachary’s autism. I had always wondered about whether or not this was “accepted practice”, but, at the time, I had been so concerned about the fact that Zachary had broken his arm and the pain it had caused him (he cried incessantly), I just wanted it fixed with the least amount of stress and pain possible – but I certainly had raised my concerns and desire to have him only get a local anesthetic. In the end, however, I went with the “experts” and agreed to the

general anesthesia. Since we had no health insurance, that simple broken arm ended up costing us over \$5,500.00 – unbelievable! Zachary had only in the last two months started to show more conversation (the anesthesia had happened over a year ago).

Andrew, due to his heart operation, at approximately age 5, had also undergone general anesthesia – for a much longer period than had Zachary. Andrew spoke incessantly (a sign of right temporal lobe damage). He also had greater difficulty in remembering certain things than Zachary did. Andrew was now 11 years of age and other than being autistic, physically, he could now run, play, and live the life of a very active child. His mother could not recall exactly when speech “took off”, but she did state that she did not feel it was right away after the operation. She had been told that **better cardiac capacity could result in improved speech.**

Patrick had undergone the most anesthesia as a result of his two failed kidney transplant operations. He also exhibited **the most** “incessant talking”.

As I considered these three boys, their autistic characteristics, and their exposure to anesthesia, a few things became very troubling.

My sister-in-law had been told that “more talking” was the result of the heart working better. But, was it? I suspected, in my “non-medical” opinion, that it had less to do with heart functioning and more to do with temporal lobe damage.

Patrick had undergone several operations. He was a fighter and I truly admired his determination and will to live. Over the years, however, Patrick had become weaker and weaker. An extended conversation was now enough to make him very tired. He was very, very pale (with almost transparent like skin) - to me, indicating a poor circulation - and as such, a badly functioning heart. **Although dialysis was also tied to “the blood”, the simple fact was that dialysis did not change the color of the blood... the blood was red when it left the body and it was still red when it reentered the body. So dialysis alone, could not change Patrick’s overall skin color!** Patrick’s “skin color”, in my “non-medical” opinion, was due more to his poor circulation than his kidney impairment. Given the fact that it now took very little to completely exhaust him, I could only suspect that his lungs were very, very weak also. Any physical activity totally exhausted him. Yet, Patrick, the boy who had undergone so much anesthesia and who had the weakest heart of all, did the most “incessant talking” of all three boys – again, a sign of right temporal lobe damage.

Zachary’s skin color, by far, was the best of all three boys! He had the **best working heart, but still spoke the least of the three boys!** Granted, there were age differences, but, again, this was truly a matter of “degrees”... and the simple fact was that **the boy who appeared to have the weakest heart and lungs spoke the most – to me, indicating that “more speech” was not necessarily a function of better lung or heart capacity!**

As I started to consider the possible role of anesthesia in the lives of these three boys, I really wondered just how it could be that “anesthesia” could cause “better speech development” from a better functioning heart, as parents had often been told, “was a side effect” of surgical procedures. In relation to the experiences of the three boys above, this could **not** be the case.

So, why was there “more conversation” in Andrew than in Zachary, and in Patrick than in Andrew? Even when in his early teen years, Patrick had also been much more talkative than had been Andrew. The boy with the best lungs and heart spoke the least and the boy I believed to have the weakest lungs and heart spoke the most! In my “non-medical” opinion, I truly suspected this had more to do with temporal lobe damage as a result of undergoing anesthesia!

Given my theory of the brain and how it worked, this too, in my “non-medical” opinion, would make sense.

If you thought about it, general anesthesia had the effect of making one “insensitive” in that “when under” your senses basically did not work – you could not hear, smell, see, touch – and I suspect, not taste either. At least, so I thought. Thus, sensory input to all lobes was impacted, as it simply “was not experienced”! Or was it? Hence, the age-old question... if a tree fell in the forest and no one was there to hear it fall...what impact did that have from a sensory perspective? Likewise, if a sound, or say, a smell was there during surgery, but the senses were somehow numbed, did those sounds and smells have an impact on the brain anyway? I now suspected that the sense of smell may actually still be active even while under general anesthesia. As I researched the topic of brain structure and function, I soon discovered that the thalamus, the part of the brain that acted as a gateway between the central nervous system and the peripheral nervous system, was involved in sensory relays for all senses, **except the sense of smell**. This was very interesting indeed, especially given the fact that I was convinced the thalamus was somehow involved in autism... as did I believe was the corpus callosum. As stated earlier, the corpus callosum was the area of the brain often “cut” to help alleviate epileptic seizures. Yet, for patients with epilepsy, the onset of an epileptic seizure was usually accompanied by a warning – an “aura” – a smell that indicated a seizure was coming. All this was truly very interesting! I could not help but wonder what happened with the sense of smell when one was under anesthesia. Was the sense of smell “still working” even though all other senses were “numbed” under anesthesia? I now believed that this, indeed, was a strong possibility!

Both auditory and olfactory processing occurred in the temporal lobe – the very lobe associated with “incessant talking”. The olfactory cortex was located in the frontal lobe... the very lobe associated with the production of speech! What happened to the senses while under anesthesia now became an intriguing question to say the least!

What happened in terms of the sense of touch, as surgeons worked? Although, clearly, one had no sensory input “felt” from touch while under anesthesia, did that mean the brain had not somehow “captured” that input anyway? These were all very interesting questions. Touch perception existed in the parietal lobe – the lobe responsible for sensory integration and somatosensory processing. It was a well known fact that anesthesia could result in issues with somatosensory processing. Many women who had been given local anesthetics during childbirth often lost control over bowel movement.

In this artificially induced sleep, only your brain stem activity, those things vital to life, continued, apparently, to work – so we thought! But, did the brain continue to “capture” the sensory information as well? I had absolutely - no idea! If it did however, what would happen to that information once a person “came out” of anesthesia-induced sleep?

In normal sleep, all sensory input was still very much working and still very much being integrated. The simple fact that I could hear a fire alarm or smell smoke, and awake as a result of sensory input, clearly showed that sensory input, integration and processing (relaying of information) as it related to vital functions and motor functions (making me open my eyes, get out of bed and out of the house), still worked while I slept. Yet, if a fire alarm went off or I smelled smoke while under anesthesia, I highly doubt I could awaken and leave the building on my own given sensory input, integration, processing and relaying were being blocked in terms of reaching my brain stem, so necessary to life functions and sight/sound reflexes. Interestingly, olfactory processing was in the temporal lobe (the lobe also associated with incessant speech) and in the frontal lobe (the lobe associated with speech production) – and the thalamus, the gateway for sensory information between the central and peripheral nervous systems, from what I could find, was not involved in the relay of olfactory information. Yet, sensory information as it related to the sense of smell also had to play some role in the parietal lobe (where sensory information was integrated), in the thalamus, and corpus callosum (the body's two gateways) and possibly in the **pons as well – that part of the brain that linked the medulla and the thalamus.**

**From what I could see, there were therefore, three gateways, the corpus callosum, the thalamus... and the pons – the pons being the critical gateway involved in sensory and motor functions to the brain stem – where all life functions resided! Interestingly, the thalamus was involved in all sensory processing EXCEPT for olfactory (smell) processing. The olfactory cortex was located in the frontal lobe and olfactory processing was believed to occur in the temporal lobe!**

As such, anesthesia, by actually numbing sensory “perception” was a very different “sleep” in regards to “sensory input” than was normal sleep! But, did that mean that sensory input was not somehow “captured” anyway by the brain even while under anesthesia? I was beginning to think that olfactory input was indeed at play here and still somewhat active even under anesthesia.

Although this was simply my “non-medical” opinion, I had to believe that somehow, the corpus callosum, the thalamus, the pons and the temporal and parietal lobes – again – had to be “at play”. The corpus callosum, thalamus and pons seemed to all act as “gateways” in terms of sensory information, and the parietal lobe where integrated sensory information resided, but where also, somatosensory and touch processing seemed to reside and finally the temporal lobe, where auditory and olfactory processing resided – all had to play a role.

Visual processing – although not an issue with anesthesia, was located in the occipital lobe.

The “anesthesia-induced sleep” did impact overall functions as they related to life functions much in the same way they would be impacted in normal sleep, reducing the rate of vital functions to life. Its real impact, however was much more as it related to the flow of sensory information – either eliminating it completely (in the sense that input to the senses was not even “perceived” by the brain or numbing it completely (in the sense that even if captured by the brain, it was not being integrated and relayed)! Thus, it appeared the impact of anesthesia was only mild in terms of the brainstem life functions, but clearly impacted the functioning of the corpus callosum, thalamus and pons much more seriously.



I now also wondered, how longer exposure to anesthesia impacted both the parietal and temporal lobes in terms of sensory processing, integration and relaying of information.

Given what I knew to be true in these three boys, and the known structure and functioning of the brain, I now believed in my totally “non-medical” opinion, that, “incessant speech” possibly resulted from damage to the temporal lobe as a result of anesthesia gases inhaled – or smelled - during surgery. The case for incessant speech, indeed seemed stronger when viewed from a “sensory perspective” in terms of what was going on with the senses during anesthesia than it did from a purely life function enhancement perspective.

The fact was that with sensory input that had entered the four lobes via the central nervous system or with incoming sensory input from the peripheral nervous system, by the time either form of sensory input (from central nervous system or peripheral nervous system) had reached the pons, **it had already been integrated by the corpus callosum or transferred to the thalamus to then be relayed to the pons in relation to life functions.** Thus, this sensory information was no longer simply “raw sensory data”... it had already undergone extensive integration, processing and relaying functions. If “raw data” was not entering the brainstem via the pons, how could “raw data” leave the brainstem to flow “backwards”. I did not believe that occurred at all. There was no “raw data” from a sensory input perspective in the brainstem. As such, I wondered, how increased heart functioning possibly caused greater speech? In my “non-medical opinion” all that was happening in such things as heart surgery, was “something” **related to life functions themselves**... heart beat, breathing, digestion, swallowing, reflexes, regulation in body temperature, blood pressure, alertness, sleep and balance. I just could not see how any information could flow backwards to lead to “better speech” given these functions were isolated within the brain stem and the fact that no raw sensory input necessary to speech was present in the brain stem. Yes, you needed to breathe to speak... but there were plenty of speechless people who breathed too! As such, again, I simply did not believe that “life functions” were related to “speech functions” any more than they were related to **any non-vital functions to life.**

If the theory that increased speech was due to better functioning of say the heart and lungs were true, than, **many more functions** should also be better... but, clearly, that was not the case. A deaf person undergoing heart surgery remained deaf even after surgery. A blind person, undergoing heart surgery remained blind even after heart surgery. A paralyzed person undergoing heart surgery remained paralyzed even after heart surgery. A mute person undergoing heart surgery, it was believed, remained mute even after undergoing heart surgery. So, how had a nonverbal autistic boy gone into surgery without the ability to speak, yet two weeks later was very verbal? How long did anesthesia really impact the brain? To “come out” or awaken from anesthesia, the blood had to process the gas to make it leave the body via the lungs, but did all anesthetic gas molecules leave the brain? I truly wondered!

Given I now believed the sense of smell could possibly actually trigger motor function as it related to speech production, this could certainly explain why the autistic child who entered surgery mute, later became verbal. I suspected **gases** used in anesthesia or some other olfactory input in the form of a pre-medicating nasal or oral prep for sedation - an olfactory input to the frontal lobe - had been responsible for the production of language and played more of a role in

this child's recovery of speech than did the secretin injection – especially given the fact that I knew helium, also a gas, affected the vocal cords! I now suspected that although a patient did not “perceive” sensory input via the four lobes while under general anesthesia, that sensory input, somehow still was captured by the four lobes and triggered some sensory response – in this case, the sense of smell, could if my theory were true, surely have triggered the production of language given both the olfactory cortex and the production of language were located in the frontal lobe and the thalamus was not involved in the processing of sensory information as it related to the sense of smell!

The brain stem involved functions vital to life only – heart rate, breathing, digestion, swallowing, reflexes, regulation of body temperature via sweating, blood pressure, alertness level, sleep and balance (vestibular issues). Better life functions, in and of themselves did not result in better sensory processing... the blind remained blind... and the deaf remained deaf... those paralyzed as a result of spinal cord injury remained paralyzed... only the sense of smell could possibly have played a role in the recovery of this autistic child's language!

In my opinion, the effect of sensory input was virtually non-existent in the brain stem with the exception of sight/sound reflexes! As such, damage to the senses, truly, as expected, would have very little impact on one's life functions! One could be blind, deaf, paralyzed as a result of nerve damage or a spinal cord injury, etc., and still be quite alive!

I could only conclude, in my very “non-medical opinion” that “improved life functions” did not play a role in the **generation** of speech, although they certainly could play a role in the capacity of speech (i.e., better breathing leading to better enunciation). However, **generation and capacity were two very separate issues!**

In view of my theory, I looked at it in terms of how it related to these three boys and possible temporal lobe impact as a result of anesthesia! I use the word “impact” here, because, I do not necessarily know that all impacts could be “bad” or “negative”. In my view, some of these impacts were definitely bad, others, perhaps enhanced certain functioning. The temporal lobe was responsible for auditory and olfactory processing, memory acquisition, emotion, understanding language, categorization of objects, and some visual perception. Current research indicated that if the temporal lobe was damaged, one could experience selective attention in terms of sight and sound, difficulty understanding spoken words, issues with interest in sexual behavior, short term memory loss and interference with long-term memory loss, emotional issues (i.e., increased aggression), difficulty in face recognition, categorization issues and the persistent talking! Once again – how interesting!

In comparing Zachary and Andrew, my son and that of my sister-in-law, Zachary definitely did grasp math concepts much, much more easily than Andrew had. At age 11, Andrew could barely add numbers higher than the sum of 10 and he was very dependent on visual and motor input in doing math. By age 12, he could finally do basic math a little better. For Andrew, there appeared to be less ability to process an auditory input – a math question verbally asked. Yet, Zachary could often give me the answer to basic addition based on a question alone. Andrew was much, more aggressive than Zachary. Overall, Zachary was a very mild child. Although there could be simply age related factors there associated with the fact that Andrew had

experienced so many more frustrations than had Zachary simply based on age alone, I could not help but wonder! Zachary had also been cdfg for over two years now. Andrew had never been placed on a cdfg diet. Zachary had been on digestive enzymes for just over 6 months now. Andrew only started to take digestive enzymes in September of 2002.

Andrew's emotions, generally, I found were more difficult to control than Zachary's... and there definitely was the fact that Andrew had more in terms of persistent or rapid speech, whereas Zachary was, overall, a much more quiet child – talking and answering some questions, but certainly not showing any signs, at least not yet, of rapid or incessant speech.

Patrick, as long as I had known him, and that was well over 10 years, had always been a very mild, non-aggressive person. He was very calm and easy going in spite of his overwhelming medical condition. Undoubtedly, the need for dialysis, from early on in life had taught him patience. All three boys had a fantastic ability to remember facts. From an auditory perspective, Patrick understood the most in terms of answering questions, then, I would say Zachary, followed by Andrew if those questions had to do with math. In terms of questions related to other activities, I believed Patrick would again be first, then Andrew, then Zachary... in terms of overall language comprehension. Given the great variance in age – 30, 11 and 5 - that alone, however, I felt could be the reason for this variation among the boys. This was as much information as I could really provide in comparing these three boys at this time in terms of functions within the temporal lobe.

My limited observations of these three boys, in relation to one another, certainly opened entirely new areas of interest. Yet, as limited as these observations had been, they certainly were completely in line with this theory that language in the autistic child who had entered surgery mute and become verbal could have been solely triggered by an olfactory sensory input, based on brain structure - this certainly seemed plausible.

**Could the “smell” of anesthesia actually *awaken* us to new possibilities in terms of brain research and possible options while still keeping in mind the effects of temporal lobe damage? - effects that were very serious indeed! Yet, there were other issues too that now had to be considered! How many women who had autistic children had undergone anesthesia (C-section) when that child was born? What about epidurals? The simple fact that 10,000 people per year died from anesthesia alone should have awakened us to the fact that this was “no simple procedure without risk”. Perhaps many had lived through anesthesia only for us to discover later that they had possibly suffered temporal lobe damage. Again, the implications of this, for society, I knew were huge! All this was but a theory, but, from a “common sense” perspective, it certainly appeared that this could be quite probable – that anesthesia could play a role in temporal lobe damage and result in incessant speech.**

Could anesthesia explain the 10% of cases known as “infantile autism”, those cases where autism was present from birth? I knew in my heart that Zachary had issues from very early on. I, myself, had never undergone anesthesia. I did, however, have a mouthful of silver fillings – mercury – and I suspected some of those could have “leaked” into my system and caused the damage – as could have the booster shot I received well before getting pregnant. From what I

had read in the US Autism Ambassador's book, *Autism and Vaccines The Story A Closer Look*, there seemed to be research indicating that vaccinations could trigger illnesses several years away. **I had also discovered that many nursery lamps also contained mercury. Surely, as these lamps heated, there could be the possibility of mercury fumes being emitted above infants in maternity wards.**

There were now so many issues potentially involved in autism – vaccinations, mercury fillings and now, possibly – anesthesia and nursery lamps! Given some of the research I had read, vaccinations and mercury fillings were definite possibilities. In speaking with the US Autism Ambassador, she mentioned that anesthesia, in her opinion, could definitely also be an issue based on research findings she had seen as they related to autistic children and the fact that many of them required oxygen at birth. My sister-in-law had undergone anesthesia. Andrew had been a very difficult birth, and after 30 hours of labor, the decision was made to go with a C-section. All these things now went through my mind!”

### ***End of quote, book 2, Breaking The Code To Remove The Shackles Of Autism: When The Parts Are Not Understood And The Whole Is Lost!***

As I thought about all these issues, I became more and more convinced that the sense of smell – found in both the frontal lobe (language production) and temporal lobe (comprehension of language) was indeed the key to **actually triggering** – language production!

Again, this would make complete sense if you considered the fact that a person had in the frontal lobes, a right and a left olfactory bulb. Given pretty well everything appeared to “cross over” in the brain that would mean that the left olfactory bulb (frontal lobe) would be tied to olfactory processing (temporal lobe) in the right temporal lobe – the very area tied to incessant speech when damaged! Thus, the sense of smell certainly could provide a link for “language production” between Broca's area in the frontal lobe and the right temporal lobe – a part of the brain associated with “incessant speech” when damaged – a part of the brain not otherwise associated with “speech production”. The sense of smell appeared to be the one thing tying “speech production” in both parts of the brain – the left frontal lobe and the right temporal lobe!

This **could** mean that the actual “**production**” of speech was in the **left frontal lobe** – or **Broca's area** – but that, possibly, the “**control knob**” involved in turning speech “**on or off and the volume control in terms of how much speech**” could actually be located in **the right temporal lobe!** This would also explain why speech **production** in Dr. Lazar's AVM patients had not been impacted when the frontal lobe had been anesthetized! To impact speech production, you had to impact either the “control knob” or the actual muscles or physical structures involved in speech production (i.e., vocal cords, etc.).

The more I thought about all this, the more it made sense. Indeed, if you looked at “other functions” in the brain, they too were “scattered”. For example, in looking at “motor activity”, you had motor functions, the planning and execution of motor functions, activity in response to the environment (also motor), memory relating to motor activities and habits all located in the frontal lobe. Yet, the **coordination** of motor functions was located in the cerebellum – a completely different part of the brain.

Likewise, if you looked at vision, you saw much of the same type of thing. Although visual functions were primarily in the occipital lobe, you had visual attention in the parietal lobe, and visual perception as it related to faces, places and body parts in the temporal lobe. There were also functions related to vision in the cerebellum (i.e., reflex and motor responses tied to vision, etc.). Thus, again, you could have some aspects of vision in one part of the brain, and yet others in a completely different area.

Emotions were again very much the same. You had “control of emotions” and things like “translating judgments into appropriate feelings or responses” in the frontal lobe, perception of emotion in others in the amygdale (part of limbic system) – that structure that appeared to “integrate” much of the “emotional” info in our bodies, the basal ganglia (reward/punishment/motivation, learned skills having to do with emotions, etc.), responses to emotions in the autonomic systems of the body (i.e., medulla and hormone systems) to allow you to “respond” to certain emotions (i.e., fear, stress, etc.), emotion as it relates to auditory and visual processing (i.e., tone and face or body language) in the right temporal lobe, emotion as it relates to words in the left temporal lobe, and some functions tied to emotions in the cerebellum. Interestingly, some research appeared to indicate that only by stimulating the amygdale could one generate the emotion of “fear” – something I had only very recently read.

Note that with emotions, the “control knob” was located in the frontal lobe and that emotions in children with autism tended to be in “extremes in terms of volume” – meaning that emotions were felt very, very intensely – or basically, not at all. This was also true of the perception of emotions in others. It seemed the “control knob” for perception of emotions was turned down very, very low in children with autism. That, made me wonder if the “control knob” for perception of emotion in others was located not in the temporal lobe, but in the amygdale. As such, it seemed each aspect to a specific function could very well have its own “control knob”. Note again, also, that emotions appeared to have their own “control knob” for the integration of emotion function too – the amygdale – the same area also responsible for the perception of emotions in others.

Clearly, the entire area of “emotions” was so complicated, involving sensory input, behavior, autonomic functions (i.e., hormones, reflexes), etc., that, in order to get an “appropriate” response, all of these inputs had to be properly integrated. Would this not be the same of basically all functions in the human brain? Was smell not also tied to motions, emotion, hormones, reflexes and so many other things in life?

Clearly, sensory input was integrated in the parietal lobe in order to allow for the understanding of a single concept. Likewise, the thalamus acted as a gateway between the information flowing between the cerebral cortex and the peripheral nervous system. The pons acted as a gateway between the thalamus and the medulla (where life functions were located). The corpus callosum acted as a regulator of information between the left and right hemisphere. Did that mean that these were “centers for integration” of information? Or were they only centers for relaying information that was already integrated somewhere else? Again, where were the “control knobs” and the “integration functions” for so many tasks accomplished in the human brain and/or body?

Interestingly, the sense of smell was the only sense that could bypass the thalamus. Why was that? What was it that made the sense of smell – so different? And, if it need not go through the thalamus for the “integration” function in terms of other senses, where was information as it related to the sense of smell “integrated” with information from other senses?

Clearly, if most critical functions in man appeared to be “scattered” in the brain not only in terms of the actual functions themselves but also in terms of the “*control knobs*” and “integrators” for those functions, why would we not assume the same to be true for language production – clearly a very key and very complicated function in humans. In my opinion, there simply had to be much, much more to language production than mainly “Broca’s area” and the coordination of muscles.

As I looked at the brain and its various tasks, it appeared that in so much, you could have perception in one area, production in another, control in yet another, integration of relevant information or sensory input for that task in yet another, understanding in yet another, planning in yet another, etc.

Indeed, language production seemed to require a great deal more than just the actual “production” of language. Did I not also have to “perceive” language production not only in others, but, in myself? Did I not have to “control” language production and know when to turn it on or off? Did I not have to “understand” language production (what I was actually verbalizing)? Did I not have to coordinate language production? Did I not have to somehow be “motivated” to produce language? Did I not have to integrate many factors (i.e., emotions, situations, sensory input, etc.) prior to language production? Did I not have to decide what “type” of language to use in the production of language? “Language production”, after all, could involve verbal/spoken language, written language, sign or motor language, body language (i.e., rolling eyes, body posture), etc. In a “normal” person, you would think the answers to these questions were “yes”, but was that really true?

Could I not “just produce language” with no understanding, perception or control of it? In my opinion, the answer to that was yes – the actual verbalization could be “just that” – “only verbalizations” or just the physical production of language – without any understanding of the language *production* itself. Note that I was not talking about the understanding of language here, but an “awareness” of sorts of actual language *production* – thus, an understanding of the language production itself. Although the function itself could be just a “physical production of language”, clearly, it could involve other parts of the brain that also played into “actual language production” – that made sense not only to others – but to myself as well – and that, could involve areas that would need to be responsible for a “yes” to the questions above relating to the “perception” of language production (i.e., an awareness that I was actually speaking), the “control” of language production (i.e., my ability to speak or not speak at will), the coordination of language production (i.e., putting words together in the proper order), the integration of all aspects necessary for the actual language production to occur (i.e., taking into consideration tone, pitch, body language in others, emotions, etc.), and so on. As such, language production involved a great deal more than just the actual “verbalization” of language. Broca’s area was perhaps involved in the actual production of language, but I suspected many other areas of the

brain were perhaps involved in “other language production functions” too (i.e., perception, control, coordination, integration of language production functions, etc.).

As such, to assume that Broca’s language was basically “the key” area” for language production was a very bad assumption to make because clearly, most major functions in the brain had several key areas that needed to work together to accomplish a specific task – not just one! Given language was one of the primary things that set man apart from animals, I very much doubted this critical function was “that simple” when it came to the brain. Indeed, I now suspected that there were many, many, many areas tied to language production in the human brain – and that many of those areas could very well involve what had so long been seen as the most primitive sense of all, the sense I now believed to be among the most intricate and complicated of all – the sense of smell.

The fact that language production as we knew it today – Broca’s area , the sense of smell and motor functions were co-located in the frontal lobe only further solidified my suspicions. Only smell was found as a “sense” in this part of the brain – the frontal lobe. More and more, I wondered if the “sense” found in a specific region (i.e., the frontal lobe) did not actually somehow “*trigger*” other functions co-located in that area of the brain!

Interestingly, the sense of smell was the only sense to by-pass the thalamus – that part of the brain that controlled information flow to the cerebral cortex (the 4 lobes) and acted as a gateway between the central nervous system (brain and spinal cord only) and the peripheral nervous system (anything outside the brain and spinal cord). ***Note that it certainly appeared that “language production” itself was not dependent on the other senses.*** I could “produce language” without the ability to see, hear, touch, or taste. But, I certainly needed the sense of smell to produce language given that sense involved – respiration! In my opinion, ***it certainly was interesting that the only sense to by-pass the thalamus was also the only sense that appeared to be absolutely necessary for language production and the only sense actually co-located with the known language production area of the brain – Broca’s area – located in the frontal lobe.***

This was all very interesting when you looked at all other functions in the brain as they related to the sense of smell, their relationship to other brain functions and whether or not they were “needed” to perform something else. For example, although the production of language itself did not appear to be dependent on “other senses”, clearly, the understanding of language was. The understanding of language produced by others involved either the sense of hearing, sight, or touch. Each of these went through the thalamus. As such, it certainly appeared that the thalamus could play some role in the understanding of language. Likewise, face and voice recognition were dependent on senses that went through the thalamus. The more I looked at the sense of smell, the more I became fascinated by it.

In looking at the sense of smell, there could be no doubt that those structures in the nose were a direct link to the frontal lobe. Indeed, smell appeared to provide the quickest route or access to the brain when it came to body chemistry, as clearly evidenced by the fact that so many drugs were “inhaled”. The sense of smell was discussed in much greater detail in both my second and third books, *Breaking The Code To Remove The Shackles Of Autism: When The Parts Are Not*

Understood And The Whole Is Lost! and Breaking The Code: Putting Pieces In Place! In my opinion, the sense of smell was the most fascinating of all in view of what it appeared to be tied to in the human body and/or brain (i.e., motions, emotions, memories, higher thought processes (i.e., imagination, etc.), sexuality, identification of the self and others, and yes, it appeared – at least in my opinion – even language production).

Our “most primitive sense” appeared to be anything but “primitive” – especially when one considered that “breathing” played an extremely important role in ridding the body of toxins (i.e., carbon dioxide, etc.) and as such, clearly, the sense of smell also very much played into the immune system and other functions so necessary to life as well, such as sleep, digestion, alertness, arousal, heart rate (i.e., smell of smoke), and on and on and on. What was it about “breathing in gas” that was so very different? Clearly, there were other ways to rid the body of toxins. That could be done via the liver, the kidneys, the urine, the feces, etc. Why was it that some functions required “gas exchange” and others did not? What was it about the “gas itself” and the sense of smell that was “so special” – especially as it related to the production of speech?

There could be no denying that the production of speech required gases moving in and out of the lungs. One could not hold his breath and still be able to speak nor could one continue speaking once gas had exited the lungs – one had to stop and take - another breath! I could not help but think that the actual production of speech was tied to “gases” we inhaled much more intricately than we may have ever imagined. The fact that helium was known to impact the vocal cords, and hence, production of speech, and the fact that at least 4 boys with autism (1 appearing to be an undiagnosed case of autism) who underwent anesthesia appeared to have language production functions somehow impacted, only made me more convinced that this was indeed the case – that gases somehow impacted the area of language production in the brain – both Broca’s area and what I now considered the “speech production control knob” – the right temporal lobe – both areas linked directly to the sense of smell!

As there was no denying that the lungs were necessary for speech, so was it true of the vocal cords. I had found a website that discussed the issue of “grunting” and how it was related to proper breathing and the vocal cords and that grunting could be a sign of respiratory distress. I quote:

***“Five common presenting physical signs relay indirect information regarding pulmonary function. These are respiratory rate, retractions, nasal flaring, grunting, and cyanosis... nasal flaring is another sign of respiratory distress frequently observed in infants... grunting... with normal breathing the vocal cords abduct during inspiration and adduct (without any sound) during expiration. When respiratory function is disrupted, the work of breathing is greatly increased, and neonates attempt to compensate by closing their vocal cords during expiration. Expiration through partially closed vocal cords produces the grunting sound. Grunting may either be intermittent or continuous depending on the severity of the lung disease. During the initial phase of expiration, the infant closes the glottis, holds air in the lungs, and produces an elevated transpulmonary pressure in the absence of airflow. During the last part of the expiratory phase, gas is expelled from the lungs against partially closed vocal cords, causing an audible grunt. It is not actually the grunt, then, that produces the elevated transpulmonary pressure, but the ability of the infant to partially close the vocal*”**



*cords after end inspiration. During the expiratory phase, when the vocal cords are partially or completely closed, there is an improved ventilation/perfusion ratio because of increased airway pressure and increased lung volume. The end result of this airway closure may be an impairment in gas exchange". [end of quote, emphasis added, Pulmonary Function In Newborn, Division of Neonatology, Cedars-Sinai Medical Center, Los Angeles, CA, <http://www.neonatology.org/syllabus/pulmonary.html>].*

Thus, this appeared to indicate that children who experienced respiratory distress had the ability to actually “close off” the vocal cords in order to facilitate breathing. Again, needless to say that was very, very interesting given 50% of children with autism were considered “non-verbal”. It certainly would be interesting to study how many “non-verbal” children with autism showed signs of “grunting” – an indication of respiratory distress. I knew Zachary had definitely exhibited “grunting” and “nasal flaring” – another sign of problems with proper breathing!

In my third book, I had also mentioned how insulin appeared to be tied to fetal lung development. Indeed, in mothers with gestational diabetes, not only was the “switch” to alpha-beta blood delayed in the unborn child, but there now appeared to be research indicating that the lungs of a full term baby may not be mature at birth in mothers with insulin problems. Throughout my entire journey with autism, the fact that Zachary had been given that “little glucose bottle” at birth because his glucose levels were low had always been in the back of my mind. I had not been specifically diagnosed with gestational diabetes during pregnancy, but I certainly suspected that I indeed did have problems with insulin metabolism. These issues, insulin, lung development and much, much more were discussed in my third book, a book I very strongly encouraged all families to read as the information in this book had certainly put many, many pieces of my puzzle in place when it came to understanding not only Zachary, but autism in general. This third book I had written was entitled, *Breaking The Code: Putting Pieces In Place!* It was available in full on my website, <http://www.autismhelpforyou.com>.

Certainly, when one thought of “speech production”, one did not think of the sense of smell as it related to the actual production of language. We all knew inhaling and exhaling was necessary for speech production, but, I suspected very few of us ever thought that the sense of smell could be involved in perhaps triggering actual language production. Broca’s area - that part of the brain associated with speech production - obviously had to have blood flowing to it. Thus, if oxygen alone was needed for language production, it certainly could be obtained via the blood. Yet it did not appear that oxygen via the blood was involved in language production but rather, perhaps it was oxygen in the form of a gas – via the nose – a structure with a direct links to the brain and hence to Broca’s area and the right temporal lobe, as well as to the amygdale – a part of the brain associated with the perception of emotion in others and as such a part of the brain very closely linked to language production – a part of the brain that was known to synapse directly with the frontal lobes – the location of the olfactory cortex – a part of the brain also very much tied to the temporal lobes... where we found functions relating to the “understanding of language” and where we, perhaps, also found the “control knob” for language production – the right temporal lobe.

Crying was a newborn’s first “production of language” – and that, clearly, involved the exchange of gases as the lungs began to work shortly after birth. Although scientists were not sure as to

what actually caused that “first breath” to be taken in an infant it certainly appeared to be the case that “gasping for that first breath” was pretty well always associated with crying – or “language production” in a newborn.

All infants appeared to cry at birth. Why was that? Why could they not simply start to breathe without crying? Was it simply because of the “shock” involved in leaving the womb - a nice, warm environment that had now been exchanged for a cold one? Was it the lights or sounds that caused an infant to cry? Was it gravity? Was it the “small slap on the bottom”? Or, could it perhaps be the fact that the lungs, as they began to function and bring oxygen to those parts of the brain involved in language production actually did just that – result in *the production of language* – in the form of – crying!

Clearly, while in the womb, the lungs functioned very, very differently and were not involved in respiration or breathing. Yet they were without a doubt very much involved in breathing and the exchange of gas and the actual *production of language* from the very first breath!

When Zachary was born, I remembered thinking it was odd that the obstetrician had not slapped his little bottom to activate the lungs but had simply touched the soles of Zachary’s feet. There had to have been basically no pain involved in that for Zachary – as there could perhaps have been with a slap on the bottom – and as such, as I now looked back, I wondered, why did all babies cry at birth! Why did the lungs not just “start to work” without crying? Why did the child simply not start to breathe in a nice, relaxed way? And why did all newborns appear to have this thing known as the “startle/Moro reflex” – a motion during which the lungs were flung wide open and then retracted. As stated in a quote in my third book, that indeed did appear to be a seemingly perfect motion to help expand the lungs at birth.

Another “reflex” that newborns appeared to have was the “gasping reflex” that seemed to occur due to the need for oxygen. In animals, the umbilical cord was pretty well automatically cut during the birthing process and this resulted in a “gasping reflex”. This “automatic severing of the umbilical” was obviously not the case in humans. In humans, the umbilical cord was much thicker and more difficult to cut, undoubtedly, providing additional protection for the child during delivery and shortly after birth. The umbilical cord provided a means for obtaining oxygen prior to the activation of the lungs. There were now concerns being raised over the fact that perhaps, modern practices were now resulting in the premature clamping of the umbilical cord. It was believed that this could lead to oxidative stress in the newborn.

Given insulin was known to impact lung development, and Zachary had been given that “little glucose bottle” at birth, I now very much suspected that Zachary’s lung were not mature at birth. Looking back, I did think his cord had been clamped rather quickly. Both my husband and daughter had witnessed Zachary’s birth and also thought the clamping had occurred almost immediately. Of course, “*cord-clamping time*” was not something hospitals recorded, and as such, I had no way of knowing exactly how long the doctor had waited prior to clamping the umbilical cord. Those studying this issue argued for at least a “*two-minute waiting period*” prior to the clamping of the cord. If indeed Zachary had immature lungs at birth, then early cord clamping certainly would have only made any already existing oxidative or respiratory stress - worse! It was a well-known fact that the brain could go approximately 4 minutes without

oxygen before brain damage occurred. As such, one could perhaps argue that early cord clamping was not an issue given the child could start breathing on his own. However, again, the key words here were “normal child” – and, in the first few minutes of birth, truly no doctor could determine “how normal” a child was in terms of “how mature” the lungs really were! As such, in a child such as Zachary, early cord clamping certainly could be a contributory factor in oxidative stress or respiratory distress. I very much suspected that in humans, perhaps there also existed this “gasping reflex” once oxygen from the cord was no longer an option for the child as the cord was either clamped or cut.

As I thought about this issue - respiration in the newborn - and of “crying” and how it related to speech production in infants at birth, I could not help but remember the first two hours of Zachary’s life. Below were words I had written in my first book, *Saving Zachary: The Death And Rebirth Of A Family Coping With Autism!*

*“My nap of two hours after Zachary’s birth was brought to a rather unusual end. I awoke to a nurse tapping on my arm and saying, “you’re going to have to take your son now, he’s been screaming for two hours straight and we can not take it anymore”. My first thought was, “you idiot, why did you let him cry that long, you should have come and woke me right away”, but I did not say anything, not wanting to upset the person who cared for my son while he was in the nursery. As soon as I took Zachary into my dark room, he fell asleep within a couple of minutes. I kept him with me pretty well until I was discharged the next day. He slept almost the entire time, although looking back, I can recall that after feedings, he had a hard time actually falling asleep and I had to walk around with him to calm him down.*

*Perhaps the first indication we should have had that something was not right was the fact that for the first two hours after his birth, Zachary cried non-stop. Looking back, I guess that should have been a sign to any parent or healthcare professional that something was wrong. Did not the fact that a newborn cried for two hours non-stop in itself seem very abnormal? Almost every newborn I had ever seen just slept in the first few hours after birth.* [end of quote, emphasis added, book 1, *Saving Zachary: The Death And Rebirth Of A Family Coping With Autism!*].

When I had first written these words, they were written in a section having to do with “nursery lamps”. I wondered if Zachary was somehow oversensitive to the heat lamps under which all newborns were placed. I did not doubt that this indeed was the case. But, now, I wondered how much of Zachary’s initial crying at birth could have been an indication of other problems – such as respiratory distress. I did not think that crying actually helped with breathing – actually, I believed just the opposite – that crying interfered with proper breathing.

Persons who were grief stricken and/or cried deeply always seemed to be gasping for air. Each time I had been so filled with sorrow and cried so deeply, I had always felt more difficulty in breathing. As such, I could not help but wonder about the role of crying and gas exchange in newborn infants as a means of activating “language production functions”.

Crying, obviously, was a means of communication in infants. Had this been Zachary's way of trying to tell all of us that something was horribly wrong? Although I now very much suspected that had been the case, I simply had no way of knowing for sure why Zachary had cried almost nonstop the first two hours after his birth. The fact that I had once read nursery lamps could have mercury in them obviously did not add to my "comfort" regarding this issue. As nursery lamps heated up, could that possibly result in mercury fumes over my newborn son? Again, I wondered what had really happened to make Zachary cry so when he was first born.

It was now appearing to me that, as had so often been the case in this journey with autism, what I had once known to be true was perhaps not the way things were after all.

Society tended to look at "crying" as pretty well simply an expression of emotion – a function with implications for the frontal lobe, temporal lobe and amygdale. Coincidentally, these were also very much parts of the brain associated with the sense of smell!

The sense of smell and the sense of taste were closely associated. Of that, I had no doubt. Yet, the critical difference between the two was that taste had to do with a "sample" on the mouth, whereas smell involved only gases – something that could actually be some distance away from the body. It was estimated that the average person could perceive approximately 200 different tastes. Yet, the sense of smell – what was considered our "most primitive" sense – was much, much more sensitive – able to distinguish, by some estimates, about 2000 various odors.

Note also that the sense of smell was the only sense that could actually by-pass the thalamus. This, again, was all very interesting given the thalamus was a major "gateway" between the central nervous system (brain plus spinal cord only) and the peripheral nervous system (everything outside the brain and spinal cord). Why was the sense of smell allowed to do this? Had the fact that the smell by-passed the thalamus played into our belief that the sense of smell was a "primitive sense", less relied on by other senses when it came to integrating our world? If that were true, then we may have made a serious error in judgment in evaluating the value of the sense of smell. Perhaps the reason the sense of smell by-passed the thalamus was due to the fact that it was so important that it needed "special processing" in terms of the relaying and integration of information from this system as it related to so much in human activity.

It was interesting to note that those senses that did go through the thalamus – taste, touch, hearing and sight, were not really critical to the function of "language production". I could have impaired taste buds and still be able to "produce language" or verbalize sounds. Likewise, I could be blind, deaf or paralyzed and still be able to "produce language" or verbalizations. Only the sense of smell – the one sense that bypassed the thalamus – was absolutely critical to actual speech production – the one sense that was found in both the frontal (olfactory cortex) and temporal lobes (olfactory processing) – both areas associated with language. The sense of smell was the only sense that could truly link language functions between the frontal and temporal lobes given this was the only sense that appeared to be found – in both – and as such, my reason for believing that the sense of smell was the key to the mystery of the right temporal lobe!

As I considered the sense of smell, I wondered why it was that this sense did not have "its own cortex" in the brain. Vision had its own lobe... why not smell, too? Perhaps the answer to that

was in the fact that vision was perhaps a much more primitive sense than smell. One could be blind and still function very, very well. Although one could have an impaired sense of smell, the fact was that without the functions associated with the sense of smell – functions such as breathing – there could be – no life! Breathing – or the gaseous exchange that occurred as a result of inhalation – a function involving the nose - was absolutely critical to life. We usually only thought of “breathing” as a “life function” located in the brainstem. But, clearly – breathing - involved something else that was very critical – the nose – and that involved both the frontal and temporal lobes! As such, although we usually did not think of the sense of smell as involved in anything other than “smelling” – clearly – in actuality – the sense of smell – what we had so long seen as perhaps the most primitive of senses – was truly the most critical of all when it came to life itself!

There could be no denying that “smell” was tied to so many critical functions in human life. It was associated with motor functions, activity in response to the environment, imagination, the concept of self, memories, and emotions and I now suspected, perhaps very much also associated with language functions. Indeed, it appeared to me that the sense of smell played more of a role in the human brain than any other sense and as such, I simply did not understand how we could have come to view this as our most “primitive sense”. I now had a whole new appreciation for what I believed was not the most primitive sense of all – but, rather – perhaps the most misunderstood sense of all - the sense of smell.

Note that the sense of smell and the sense of taste were considered the “chemical senses”. Also note that the sense of hearing was also very much impacted by the sense of smell. When the sinuses were filled with mucous, hearing was clearly impacted. Everyone knew that a plugged nose impacted hearing, but we really did not give much thought to what an infection in the ears could do in terms of impacting the proper functioning of the sense of smell.

If the nose was filled with mucous, obviously that impacted airflow. Certainly, that appeared to be something that could contribute to “oxidative stress” in infants. Obviously, gases flowing in were impacted by congestion in the nasal system. But what about gases and the impact of obstruction for gases flowing out? Was more carbon dioxide left in the body when there was congestion in the nasal passages? If so, what impact did this additional toxin have on the brain? And, what about the ear canals? If the ears were infected, what effect did that have on proper airflow within the body? Given so many children with autism had suffered from chronic earaches, I could not help but wonder how “earaches” impacted the sense of smell and its proper functioning given these systems were so very closely related and how “earaches” may contribute to “oxidative stress” in these children.

Certainly, it was well known that antibiotics used to treat earaches destroyed the healthy bacteria in the intestinal wall and as such, contributed to problems in digestion in these children. But, could antibiotics also be doing something that impaired the sense of hearing or smell in these children too? Of course, I had no way of knowing either way – although I truly wondered!

When it came to the sense of smell and children with autism, there was no denying that these children appeared to have a very, very sensitive sense of smell. Interestingly, the sense of smell was one of the only areas in the brain (the other being the hippocampus – tied to memories and

also to the sense of smell) known for a fact to continue to generate new cells throughout life according to work done by Dr. Fred Gage. Note that the amygdale, associated with memories tied to emotions, also synapsed directly with the sense of smell.

This sense of smell was intriguing indeed. Man had always wondered why the brain did not produce “new cells” throughout the brain over the course of life. So far, only two areas had been identified as “producing new cells” in the brain – the olfactory cortex and the hippocampus. Why was that? Could it be because via the production of new cells in the olfactory system, we simply did not need new cells in other regions? Could it be that new “smell cells” rejuvenated other functions too somehow? Could, via the sense of smell, other major functions not be finding “new life” also? Smell functions seemed to be found in so, so many parts of the brain. Although not technically found in the parietal lobe, could one not argue that the skin provided “air” too – and as such, indirectly, would that not involve “air exchange processes” that could then be tied to the parietal lobe given the parietal lobe involved the sense of touch, or, – the skin. Like the nose, did the skin not also – breathe? Could this somehow play into the fact that studies were finding persons who were more active physically also seemed to function longer mentally as well? There was no doubt that physical exercise was good for the body overall, but what was the role of “smell” or “gas exchange” in mental activity or functioning?

Could one have an impaired sense of smell and yet, still have great mental capability due simply to the gas exchanges going on? Clearly I could have an impaired sense of smell and be unable to actually smell something properly but yet still have that “gas exchange” going on in terms of oxygen going to my brain. Olfactory dysfunction had been well documented in autism, schizophrenia and Alzheimer’s. Zachary, for example, had a very, very sensitive sense of smell. Yet, I suspected that as he got older, this sensitivity would decrease as I very much believed his sense of smell would become not “overly sensitive” but very much less sensitive – in other words, I suspected he would begin to lose functioning in this area. Recently, I certainly had noticed that Zachary rubbed his nose a great deal and he very much showed “olfactory distress” if I could use that term. He seemed to be constantly sniffing or rubbing his nose, and this certainly was of concern to me given I now suspected the sense of smell could be tied to much more than we may ever have imagined.

Perhaps that helped to explain why so many children with autism – children who were very, very picky eaters - came to more easily accept more foods as time went on.

The reason I suspected Zachary might lose his sense of smell was because mercury appeared to target developing cells or at least, had a much greater impact on immature cells. Those cells that were the most immature of all appeared to be most targeted by mercury. In early life, that would be the cerebellum – a part of the brain that took close to twenty (20) years to mature – the very part of the brain that appeared to be most impacted in young children with autism. Yet, as time went by and most of the brain was formed, if only the olfactory cortex and the hippocampus continued to develop new cells, then, I suspected these would be the very areas targeted by mercury later in life.

Indeed, in Alzheimer’s, olfactory dysfunction was clearly documented as was the fact that the hippocampus was perhaps the area “hardest hit” by this disorder. I also suspected that for

children with autism, that changes in olfactory processing and impairment in the sense of “less smell” would be triggered with the onset of puberty – a time when the brain was known to prune and reorganize itself – a time that should normally involve gray matter thickening (new cells being formed) but that, in actuality, involved gray matter loss in persons with schizophrenia – as clearly explained in my third book, *Breaking The Code: Putting Pieces In Place!* If indeed mercury targeted immature cells, this certainly would make sense!

In my third book, I had provided over one hundred and forty (140) parallels between autism and schizophrenia and over one hundred and sixty (160) parallels between autism and Alzheimer’s. In my opinion, these were nothing more than the same disorder over the life spectrum – disorders that also all shared a very, very common history! Note that autism used to be called “childhood schizophrenia” and schizophrenia used to be called “dementia praecox” – as was also the case for Alzheimer’s. In fact, Alois Alzheimer was the protégé of Emil Kraepelin – the man who discovered schizophrenia - and they appeared to have agreed that based on age of onset – these disorders would be viewed as “different”!

Age of onset was also one of the primary considerations in distinguishing between autism and schizophrenia, completely irrelevant criteria, in my opinion, given that ***the brain was not a constant over time***. As such, how could you possibly compare a disorder involving the brain across generations when the brain underwent such tremendous change over time – and this, clearly had to play a role in what we saw in autism, verses schizophrenia, verses Alzheimer’s.

There was a great deal more provided on this issue in my third book, and I strongly encouraged all families impacted by these disorders to read this book, posted in full on my website, <http://www.autismhelpforyou.com>. Truly enlightening information!

I had looked for two days on the Internet for a “neurologist’s explanation” of “the mystery in the right temporal lobe” and how an area of the brain not associated with language production could result in incessant speech when damage to this area occurred. Many sites acknowledged the issue – stating that indeed, damage to the right temporal lobe resulted in incessant speech – but, I could find nothing that really explained why this was so. Thus, “the statement was made”, but, from what I could find, no explanation for this was provided.

Experiments dealing with subjects that had impaired speech production in terms of damage to Broca’s area seemed to simply assume that the function of speech production had simply “relocated itself” within the brain. I suspected that this indeed was not the case and that the issue was more one having to do with the actual “control knob” – the “on/off and volume” switch for language production that appeared to exist in the right temporal lobe and appeared to be very much associated with the sense of smell. As such, the function of language production had **not** “relocated itself”, but rather, we had simply perhaps stumbled upon another part of the brain associated with a particular function – in this case, the “control knob” for speech production!

If indeed the sense of smell was associated somehow with the production of language, then, speech functions perhaps were not “relocating” themselves in brain damaged patients, so much

as they were perhaps simply activating “speech production reserves” already there given functions of “smell” already resided in the temporal lobes.

Much as many different aspects relating to specific functions in the human brain were located in various parts of the brain, so too, did it appear to me that there were various “control knobs” to be found throughout the brain for these functions – and often, it appeared to me – these “control knobs” were located in an area separate from the actual “production” of the function itself or functions relating to the “integration” of critical inputs for the “production” of that function.

As I thought about everything I had learned over the past three years, and thought again about these boys with autism who had all undergone anesthesia and looked for “other explanations” to the productions of speech and/or rapid speech in these children, I could not help but wonder about “temporal lobe damage” in and of itself – somehow occurring in these boys – outside of anesthesia.

Certainly, that could be a possibility. It was a known fact that children with autism often developed seizures at puberty onset. Yet, at least in three of the four boys, Victoria Beck’s son, my nephew Andrew, and my son, Zachary, puberty had not yet been reached when these issues with speech had surfaced. I did not know enough about the fourth boy, Patrick, to comment on his situation in terms of when issues of rapid speech had surfaced. Could these boys have experienced seizures or some other type of temporal lobe damage prior to puberty – of course – that was a possibility, but that little voice inside of me still made me lean toward anesthesia as part of the answer to this particular puzzle.

Neither Zachary nor Andrew had undergone an MRI. I did not know if either Patrick or Victoria Beck’s son had undergone this procedure. It certainly would be interesting, in my opinion, if Victoria Beck’s son had undergone an MRI prior to his anesthesia – and one after this procedure requiring anesthesia – in order to compare the scans for right temporal lobe damage – something very much associated with “incessant speech”. Whether or not my theories about anesthesia would prove true or false – I supposed perhaps time would tell.

I had simply provided “my theory” – a possible clue or explanation for this mystery – in the right temporal lobe. How damage to a part of the brain not associated with speech production could result in “incessant speech” was a rather fascinating mystery indeed!

Of course, this was just “my theory” as to what we were seeing in terms of “the mystery in the right temporal lobe” and other things we were seeing in terms of brain structure and function. I suspected that as we learned more about the sense of smell, how it changed over time and, how it played into so much, that we could come to better understand perhaps not only the mystery of the right temporal lobe – but many other mysteries relating to not only specific disorders but brain structure and function in and of itself!



## Emotions... Clues To Overcoming The “Stuck On High” Control Knob...

Perhaps one of the most complicated areas to understand in human thought processing was that of emotions. Emotions were, I would argue, even more difficult to understand in the child with autism – a child who appeared to be often unable to perceive emotion in others, yet, whose own emotions often seemed “stuck in overdrive” as evidenced by the many emotional outbursts so often seen in these children as a result of something that, quite frankly, could appear so trivial to a normal person.

Clearly, in order to be able to communicate with a child with autism, there had to be the ability to control his emotions. Not surprising to me was the fact that functions having to do with emotions were co-located in the temporal lobe along with the understanding of language. Yet, the ability to perceive emotions in others was located in the amygdale and the “control knob” for emotions – or “emotion control” was located in the frontal lobe. As such, if these areas were not communicating properly, as I very much believed to be the case, one could certainly see why “emotions” in children with autism, would be so difficult not only to understand, but to control.

Throughout my journey with autism, as I continued to research, I continued to find little nuggets that helped me to better understand specific issues. For example, *the amygdale appeared to be involved not only in the perception of emotions in others, but, the amygdale, appeared to be that part of the brain could result in the experience of “fear” when stimulated. It also appeared to be an “integrator” for combining all “emotion” information in the brain.* Note that the amygdale synapsed directly with the frontal lobe – that part of the brain responsible for the “control of emotions” – and also that part of the brain very much associated with the sense of – smell – perhaps explaining why simply taking a deep breath could so powerfully help one to control one’s emotions not only in times of personal stress but in response to emotions of others also, etc.

Below were quotes relating to the subject of “emotion” taken from books I had previously written. When taken together, these quotes truly helped to understand the issue of “control of emotions” in the child with autism – and indeed, in man himself!

*“Zachary’s sense of smell did not seem to be affected, other than his general dislike for any new food. He just had to look at a new food and would turn away. Of course, I had no way of proving whether or not he could smell it from far away and smelling it was why he would run off as opposed to a visual cue of something being new. The one thing about his sense of smell I did notice from quite early on was that he liked to be “sniffed” around the ears, in his hair, on his tummy, and especially, around the neck. Actually, “sniffing” him often served as a method of calming him down. If he got upset, often all I had to do was to start sniffing him around the neck and he would calm right down. This actually also helped him to fall asleep. I never thought much of anything other than the fact that it was kind of “cute”. In fact, he “sniffed” my neck and ears first and that was how I came to recognize and use this behavior to calm him down.” [book 1].*

Since the very beginning, when Zachary was very young, the sense of smell (i.e., via sniffing) had clearly played a role in the control of his emotions. To this day, “sniffing” still calmed Zachary tremendously!

*Again, I could not help but wonder “how inter-related” all the functions within one lobe truly were! If you looked at the frontal lobe, the sense of self also resided there... along with motor activity and memory relating to motor activity. It was often said that “Actions speak louder than words”... another interesting saying. Let us take another example. The example of a person in need. If I helped that person – or failed to do so – that had an impact on my emotions (control of emotions), but that also had an impact on my concept of self. Indeed, our actions very much defined us as “the type of person we were”. Again, concept of self, control of emotions (i.e., I can not help but feel somewhat guilty if I do not help a person very much in need), and motor functions/actions... all in the same lobe. [book 2]*

*“Control of emotions was also located in the frontal lobe along with the concept of “self”. This again truly contributed to the definition of the “self”. People were often defined by their ability to control their emotions (i.e., hot heads, etc.). Note that although the control of emotions resided in the frontal lobe – along with the concept of “self” – emotions themselves resided elsewhere – in the area of the temporal lobe/amygdale. Thus, again, if little or no communication existed between the frontal lobe and these other areas, potentially one could experience an emotion and be unable to control it!” [book 3]*

Thus, a person’s ability to “control his emotions” helped define the concept of self – a function co-located in the frontal lobe along with “control of emotions”.

*“I had also found it interesting that control of emotions was co-located with production of speech given the fact that it was well known that often, persons who experienced great trauma often – literally - lost the ability to speak. Was it possible that trauma resulted in a loss of control over emotions and that this had something to do with the production of language itself? Just how was “control of emotions” tied to actual language production? The experience of a strong emotion or emotion in general seemed to be located in the temporal lobe/amygdale area of the brain. Also located in the temporal lobe was the “understanding of language”. Did the experience of a strong emotion have anything to do with the “blank” stares so often given when one experienced trauma – that apparent “inability” to understand the spoken language? In my opinion, this was all very interesting indeed!” [book 3]*

Thus, emotions appeared to also play a part in actual “language production” – also co-located in the frontal lobe along with “control of emotions” as well as in the “understanding of language”, co-located in the temporal lobe along with functions relating to the experiencing of “emotion”.

*“The more I look into matters relating to the possible role of the sense of smell, the more I found it absolutely fascinating. It was a well-known fact that people were usually more depressed in the winter and had “spring fever” - that intense feeling of “being alive” and “wanting to go out to enjoy a beautiful day” in the spring. The spring brought with it so many “beautiful smells”. The control of emotions was located in the frontal lobe along with the sense of smell.” [book 3]*

*“Flowers always made a woman “feel better” or “special”. Sure, there was the physical beauty of a flower, but could it actually be the smell that “lifted emotions”? I now tended to think smell had a great deal more to do with the control of emotions than had ever been thought... and that perhaps all “functions” located within one specific lobe were actually very much inter-related. [book 2]*

*It was a well-known fact that women loved to eat when depressed... chocolate and ice cream especially... :o)... both having to do with the sense of smell. Of course, in trying to “feel better” by eating, pounds were usually gained. As those extra pounds were reflected in the mirror (visual perception and emotion were in the temporal lobe, visual processing in the occipital lobe), depression could certainly set in (emotion in the temporal lobe) but the control of that emotion could be made more difficult by the fact that emotion control resided in the frontal lobe... not in the temporal lobe... where emotions seemed to be “felt”. The concept of self also resided in the frontal lobe... so, to see oneself as “fat” (visual perception in the temporal lobe, visual processing in the occipital lobe) may be hard to counter emotionally (i.e., the depression), since concept of self, control of emotions, and motor functions (i.e., the act of eating) were together in the frontal lobe. The battle of the bulge, when viewed in light of neural degeneration due to mercury exposure was perhaps more of a battle than anyone had ever thought possible! [book 2]*

*Control of emotions and the sense of smell... truly an interesting topic. We had a lot of “sayings” in life that truly indicated smell played a role in the control of emotions. For example, to express the emotion of relaxation or the need to enjoy life, we had the saying: “Take the time to smell the roses”. To express disappointment, we had the saying: “That stinks!”... another “smell” related saying relating to emotions. To express love or devotion, we had the saying: “The way to a man’s heart is through his stomach”... another “smell” saying relating to emotions (taste and smell go together). To express vengeance we had the saying: “I’ll give him a taste of his own medicine”. Depending on tone used, we could also express excitement or disgust via the expression: “That’s just peachy”... another “smell” or “taste” expression for emotions. To express suspicion, we had expressions like: “That’s fishy” or “I smell a rat”... again, emotion expressed via the sense of smell! To express matters relating to one’s motivation or matters of corruption, we spoke of the “smell of money”. Note that motivation and corruption had to do with one’s actions (motor functions and the concept of self – also in the frontal lobe). [book 2]*

*As such, the sense of smell also provided opportunities for helping in matters of control of emotions. Often, if Zachary was upset, all I had to do was say, “do you want a glass a rice milk?” to trigger a word association of “something good” to help him regain control of his emotions. The senses of taste and smell were critical to emotion control and certainly explained why preferred “treats” could help bring a child “under control”. [book 3]*

There could be no denying that the sense of smell clearly impacted a person’s “moods” or “emotions”. Again, functions for both smell and emotion were co-located in several parts of the brain – the frontal lobe (smell and control of emotions), the temporal lobe (smell and the experiencing of emotion), the amygdale (smell and the experience of fear, memories that evoked emotion, center for the integration of “emotion” functions).

*The control of emotions had to be dependent on those “other functions” found in the frontal lobe – smell, motor activity, language production, higher functioning (concept of self, imagination, reasoning, etc.), and the assignment of meaning to words [word associations]. This explained why having Zachary repeat “it’s ok” had worked so well for him in helping to control his emotions (see *Breaking The Code To Remove The Shackles Of Autism: When The Parts Are Not Understood And The Whole Is Lost!*). This simple phrase involved language production and word associations and if my theory that the functions within a specific part of the brain were much more closely related than we could ever have imaged were correct – that would mean that simply “saying the right thing” [production/word association] – could have implications for the actual control of emotions as well given these were functions co-located in the frontal lobe. [book 3].*

*Reducing stress levels for Zachary had always been a priority for me, and now, this had even greater importance. Simple things like “words to cope” and attending immediately to his distress and showing him how to “ask for help” via word associations, for Zachary, I now knew would be more key than ever. Words to cope (i.e., word associations) had always been so very important to reducing Zachary’s stress levels. I now understood why. As such, these simple phrases would always continue to be constantly used in our home. Whenever Zachary became upset, I simply said: “just try again... or it’s ok... or when you have trouble... just ask for help” and I made him verbally repeat these phrases by saying: “Zachary, say... it’s ok”. I had always found that if Zachary actually verbalized these key “words to cope”, he dealt more easily with the stress. This now made sense to me given control of emotions, word associations and language production were all co-located in the frontal lobe! [book 3]*

*Of all of these functions “verbalized word association” – involving language production and word associations - in the frontal lobe – what I had referred to as “words to cope” in my second book - provided perhaps the best opportunity to help children with autism “maintain control” or “regain control” because verbal word associations were nothing more than “categorizations” relating to “emotions” and that provided a bridge to the temporal lobe where functions relating to categorization, emotions, understanding of language, memory acquisition, auditory processing, etc. were located – all functions certainly necessary to the control of emotions – something that was found in the frontal lobe. Thus the key was to somehow “bridge” the frontal and temporal lobe by using those functions that had “parallels” between the two. Interestingly, the most obvious parallel was probably that of smell – a sense that had functions in both the frontal and temporal lobe. This certainly could explain why “treats” worked so well in behavior therapy. [book 3]*

Control of emotions, smell and word associations were also co-located in the frontal lobe and as such, this certainly explained why simple word associations were often enough to help Zachary “regain control” of his emotions. Emotion functions, smell and categorization were also co-located in the temporal lobe.

*This certainly would also explain why Zachary was most “under control” when doing math or other “reasoning” type activities. Higher functions such as these were co-located in the frontal lobe along with “control of emotions”. This was also true of the assignment of meaning to words. There was no doubt that “word associations” triggered very specific*

*emotional responses and that one often “lost control” based on “what he heard” or maintained or regained control of emotions based on something else that had been heard – another “word association”. [book 3]*

Thus, one could also “control emotions” via specific types of activities – activities that made use of other functions co-located in the frontal lobe.

*“B6 was required for the production of epinephrine – or adrenalin – something that was used up during stressful times. As such, B6 levels definitely appeared to be tied to the levels of production of this hormone. Epinephrine – or adrenalin – was a stimulant! That certainly would explain all that “hyperactivity” in these children! Also key, again, was the link to glucose – something tied to insulin levels!*

*I could not help but wonder if the increase activity in children with autism was not also an immune system response resulting from low glucose levels. If there was one thing my son appeared to have, it certainly had to be a lot of “energy” – so much so, that I wondered how much of his B6 intake was impacted by processes dealing with the production of epinephrine – or adrenalin. If indeed adrenalin – a stimulant - was produced during stressful situations (an apparently “automatic and necessary” system response, and the life of a child with autism was “a life of stress”, did it not stand to reason that these children could be “hyper” or “overactive” because of the production of adrenalin – a stimulant - as they attempted to deal with stress? Given epinephrine or adrenalin was a muscle stimulant, could it not stimulate not just the heart, but all muscles? That certainly could be one explanation for why these children were so active!*

*Also “coincidentally”, B6 was stored primarily - in muscles! Could this explain why it was believed exercise could help protect one from Alzheimer’s? Obviously, as one exercised, B6 would be released to help provide energy for the body. In my opinion, given that B6 was associated with iron, insulin and glucose levels and given it had been shown to be so helpful to children with autism, again, the “exercise link” certainly appeared to make sense, too!*

*Also, if epinephrine was associated with the elevation of glucose levels in the body, could “hyperactivity” in these children be an actual immune system response in order to increase glucose to appropriate levels and if that indeed were the case, what would drugs used for the suppression of “hyperactivity” do to these children? Again, I truly wondered as to the implications of all this given I had seen many parents state that their children “got worse” when placed on medication! Thus, could it be that the key to reducing activity or “hyperactivity” in these children was not medication but the alleviation of stress?*

*In my opinion, this was very interesting indeed given my son’s activity levels clearly appeared to increase when his levels of stress also increased!*

*Given I now very much suspected that functions co-located in the brain were much more inter-related than we may have ever imagined, I also believed that this issue with epinephrine in children with autism could have something to do with the fact that we saw hyperactivity not only in the physical motions of these children, but in their emotions as well. Could it be that*

*elevated epinephrine levels, clearly documented in autism, resulted not only in extremes in motion but in extremes in emotions as well? I was now, very much starting to think that indeed, this could very well be the case. [book 3]*

Thus, again, it appeared that functions co-located in the brain were much more inter-related than we may have ever imagined. I now truly believed that “hyperactivity” in children with autism could very much be related to the production of adrenalin in order to deal with elevated stress levels – and as such, that hyperactivity could be an immune system response to control emotion (i.e., stress) via physical activity. Note that motor functions and control of emotions were co-located in the frontal lobe!

*Touch – as in “hugging” was obviously also important in emotions, after all, both “touch perception” and somatosensory functions were co-located in the parietal lobe...thereby explaining why a “hug” just “felt so good”. I was simply stating that unlike the importance of touch in emotions, perhaps the sense of smell had been very much overlooked not only in matters dealing with the control of emotions but also in matters as they related – to the sense of - “self”! [book 3].*

Note that “touch” was located in the parietal lobe – away from “control of emotions” in the frontal lobe and as such, “touch” (i.e., a hug) was probably not the best way to control emotion a child with autism in distress if indeed there existed little or no communication among the various parts of the brain.

Clearly there could be no denying that many, many things played into “control of emotions” and the actual “experiencing of emotions” in the child with autism as well as in a “normal person”. Likewise there could be no denying that those functions co-located with “control of emotion” functions provided perhaps our best tools for actually controlling emotion in children with autism – functions that included: motor activity/motions (i.e. playing alphabet in motion games using body parts, exercise, etc.), language production and word associations (i.e., the actual verbalization of key phrases such as “it’s ok”... “just try again”... “just *ask for help* when you don’t understand”... “just say... help me...”, “I’m ok...”, etc.), and higher functioning (i.e., math, “counting games”, etc.).

As such, to help children with autism control their emotions, for example, in social situations, those functions co-located in the frontal lobe would perhaps best help in “socialization” issues also (i.e., encourage children to socialize with other children via the use of puzzles, snacks, activities involving “motion games”, higher functioning, etc.).

As I thought about Zachary and issues with socialization, there were many things that came to mind. If indeed I were correct in that Zachary lived “via reference”, it stood to reason that as he came to build more references pertaining to “socialization” that he would naturally “do better” in these situations. I very much believed this would be the case. This year, I planned on putting Zachary in more “social situations” in order to see how well he did. It had only been in the last year that his language skills had flourished enough and I had figured out so many of the “tricks” to calming his frustrations. I was finally at a point where I felt I could tackle a little more with

Zachary in terms of “public outings or settings”. That would be “this year’s challenge” along with helping to build his conversation skills. :o)

With Zachary, although he was on a ckgf diet, I carried with me “tic tacs” almost everywhere I went in public. That way, if Zachary had any type of a “meltdown”, I could usually use his sense of taste and smell to help quickly bring him back under control – or I could draw his attention to “counting things”. Just one small “tic tac” was usually enough to do the trick. All these simple tricks worked rather well. When plans changed, I simply made sure the explanation included a statement to the effect that: “**first**, we are going to do this, **second**, we are going to do this, **third**, we are going to do this...”. If a planned activity for the day could no longer be done, I would simply do the “first, second, third explanation” and then included... “and **tomorrow**, we are going to...” as I substituted a planned activity for another day. Simply providing that “counting” of activities to be done provided the understanding Zachary needed and the “new order” to his day in terms of what we were going to be doing.

Controlling Zachary’s emotions was really, I believed, a matter of finding “the tricks” that worked based on functions co-located in the frontal lobe along with control of emotions and controlling emotions in Zachary was one thing I had learned to tackle rather well. “Meltdowns” no longer lasted very long in our household and for all of us, especially for Zachary, that had tremendously reduced his stress levels. As important as controlling “his emotions” however, was the need for Zachary to understand emotions in others. That function was co-located in the amygdale – perception of emotions in others.

Interestingly, face, voice and auditory processing were co-located in the temporal lobe along with olfactory processing (sense of smell) that synapsed directly with the amygdale. I had always found that the best way for Zachary to understand emotions in others was for him **to be told** what the other person was experiencing – in other words, the understanding of emotions in others was, at least in Zachary’s case, best understood via the use of “auditory processing” as opposed to visual processing. Again, I quote words from a book I had previously written:

*“As with so much, issues with the processing of emotions could also be explained by this theory. For example, a child may be able to visually “see” a person crying (visual sensory input), but, unless that input went to that part of the brain that dealt specifically with the processing of emotions, the amygdale, then to an autistic child that information meant nothing! There were plenty of times when I cried deeply as a result of autism and Zachary never really particularly seemed distressed over that. Yet, if I said: “I’m a sad mom”, he often came running with a kiss! Sensory input as it related to sight was primarily in the occipital lobe. Auditory processing, understanding language, voice recognition and memory as it relates to emotion were in the temporal lobe... so, my saying: “I’m a sad mom”, obviously would have a greater impact on an autistic child than would seeing me cry.” [book 2]*

As such, the “understanding of emotions” in Zachary, appeared to be much higher if auditory processing was used. Interestingly, understanding of language, auditory processing and emotion functions were co-located in the temporal lobe along with face, place and body part recognition. Thus, although **perception of emotion in others** was located in the amygdale, surely, the **understanding of those emotions** also very much involved the temporal lobe. Upon **hearing**

**“I’m a sad mom” – thus *hearing, not seeing my emotion - Zachary not only perceived my emotions, he also very much reacted to that and attempted to alleviate my sorrow as he came running with a kiss saying: “I want a happy mom”. Clearly, auditory processing in terms of both myself (“I’m a sad mom”) and Zachary himself (“I want a happy mom) was much more important than visual cues when it came to the perception of, understanding of and reaction to – emotion in others – and that, in turn also very much impacted Zachary’s emotions also! As such, in using verbalizations, I found I could easily control Zachary’s motor functions by his desire to control or help with my emotions too!***

Recognition... perception... and understanding – clearly very different functions when it came to the processing of emotions and so many other functions in the human brain!

Face recognition was one thing – “reading that face” was quite another. Zachary could recognize “who I was”, but he still had great difficulty in “reading” my expressions, although, clearly, he had also come a long way in this area also.

The following were words I had written as they related to this issue of “face perception” and what was in my opinion, a critical need – the defining of “face parts” in order to help the child understand how each part “fit into the whole”:

***“For example, the act itself of looking someone in the eyes involved "looking at 2 eyes"... that in itself was difficult for the autistic child since he could not deal with "partials" ... and the 2 eyes were simply 2 parts of the face... that in itself was a problem for the autistic child and was enough to make him want to break eye contact. But, the "part" that I had missed for so long when it came to eye contact was the fact that breaking it... with anything...a person or object... was also a coping mechanism for the autistic child. The child broke eye contact with anything that was "partial" or offended him...in the sense that it had not yet been “decoded”... be that his mother's eyes or a book. Not able to deal with the "pages"... the "parts of the whole book", the child simply chose not to focus on a particular page, but rather, often simply turned all the pages quickly, shut the book and tried to run away!***

***I had started to pay more attention to this issue of eye contact recently. I believed it was important to label each eye for the child... the left eye and the right eye. I believed it may also help to say that: "the left eye is to see things on the left" and "the right eye is to see things on the right"... and "both eyes are used to see everything - together". Again the use of labels was critical and for the autistic child, these labels had to be very, very specific when first explaining exactly how "parts" fit together to form "a whole". Just labeling these 2 things as "eyes" would not do it... you had to label each eye and explain its purpose. This was also true of all other body parts having a left and a right – although the eyes, given their proximity to one another and their “motion”, obviously posed a greater problem for the autistic child...” [book 2].***

Simply helping Zachary to understand “how a face fit together” had helped tremendously with issues of “eye contact” and Zachary’s desire to look at me when I spoke to him. There was no doubt that when it came to emotions in the child with autism, there was a great deal to consider –



everything had to be defined and explained in order to be understood - but, it was in providing those labels and that understanding of “the purpose of things” that Zachary had truly thrived!

I very much knew Zachary to be a “left brain” dominance child. That meant he should be processing faces based on “the whole”, whereas children who were “right brain dominant” were believed to process the face based on “parts”. Boys generally were more “left brain dominant” and girls, more “right brain dominant”. I certainly understood how that could be a problem given I very much felt that for the child with autism, in order to understand “the whole” they had to first understand “the parts” that made up “the whole”.

Interestingly, although the number of boys impacted by autism was significantly greater than the number of girls (4:1 ratio), was each sex impacted to the same degree? Were boys more impacted by autism or were girls? I was not sure that such a study could really be proven since so very many variables fit into the “autism equation”. The fact that more boys were impacted by autism was clearly documented when it came to “actual numbers”. Whether or not girls or boys were “more severely” impacted by the disorder itself remained to be proven. But, if there were “gender differences” in terms of “severity” of the disorder in boys versus girls, that had some rather interesting implications when we considered the “left brain” versus “right brain” theory.

Boys were generally “left brain” and that meant that they primarily had to understand things in terms of “part to the whole” – in terms of how the “details” fit together. From what I had seen in Zachary, this was certainly true.

Again, according to work done by researchers at the State University of New York at Buffalo School of Medicine, ***males were believed to scan faces with the right brain, whereas females were believed to scan faces with the left brain.*** [source: D.E. Everhart, J.L. Shucard, T. Quatrin, D.W. Shucard, "Sex-Related Differences in Event-Related Potentials, Face Recognition, and Facial Affect Processing in Prepubertal Children," *Neuropsychology*, 2001, Vol. 15, No. 3, 329–341, <http://unisci.com/stories/20013/0709014.html>].

The fact that ***boys***, however, ***processed the face using primarily the “right side” of the brain*** meant that Zachary was forced to “look at the whole ***concept***” – the face - when he was primarily a person who needed to first understand “the details”.

I wondered how all this fit into the fact that Zachary had very much focused on “my mouth” when looking at my face. Had that only been his attempt at “breaking the code to language” as he attempted to decipher sounds, etc. or could this whole issue of “right brain” versus “left brain” have played into this also. A focus on the mouth would indicate Zachary was focusing not on the “whole” face but rather on a very specific “part” to the face. Boys were said to process faces more with the “right brain”. That would mean Zachary should have been processing faces based on “the whole” as opposed to the parts. Yet, clearly, he had very much focused on “my mouth” when I spoke and as such, although studies indicated boys processed faces more with “the whole” or “right side” of the brain, children with autism, such as Zachary, in attempting to “break the code to language and communication” – even boys – focused very much on “the parts” of the face – not the whole!

Perhaps this helped to explain why it had been so very difficult in the past for Zachary to look at me in the eyes. For a very, very long time, he had only focused on the mouth. It was only in the last year or so that he had made so much progress in this area and could now much more easily look into my eyes and focus much less on “my mouth”. I suspected that this was due to the fact that he now understood so much more when it came to language and communication in general and as such, he did not have the need to “break the code to language” he had once had. He could now process my face more on “the whole” as “normal” boys would – but I suspected that had only been because he had come to a much greater understanding of the parts first!

When it came to issues of children with autism “***focusing on the mouth***” of persons who spoke or interacted with them, I was now beginning to suspect that these children did this for a very specific reason. Indeed, if boys perceived things primarily “in parts” in order to understand, that could, at least, in part, help explain this issue of focusing on the mouth – that part of the body “***emitting language***” so very obviously in humans. Thus, if I were a child “attempting to break the code to language” – the mouth, in my opinion, would absolutely be the area “of focus”.

When I combined that with the fact that the “understanding of language” was co-located in the temporal lobe along with “auditory processing” and the fact that “the mouth” certainly provided for “auditory input” to the child with autism – again, I saw that, truly, “a focus on the mouth” seemed to be exactly what was needed to “decode language” – at least “verbal language”. When I considered other functions co-located in the temporal lobe along with the understanding of language, functions such as “categorization” (i.e., necessary to categorize or make sense of all these sounds), functions such as “visual perception” – specifically as it related to face and body part recognition, functions such as “memory acquisition” – again, so critical to language comprehension – I simply could not help but again, suspect my theories could absolutely prove to be true. And, if they were, could it be any wonder why these children – almost universally – focused on “the mouth”. In my opinion, they were absolutely trying to “break the code” to language by doing this. Perhaps the fact that they did this – so universally – should have been - “our first clue” – that there was “something important to this focus on the mouth issue”!

As such, I could not again help but feel tremendous sorrow as I thought of the many, many children who had been in behavior modification programs that had emphasized a “focus on the eyes” for communication “breakthroughs”. While adults were “focusing on the eyes” – in my opinion – ***they were clearly failing to see*** the very issue before them – that, perhaps, given all these children appeared to focus on the mouth – that this was where the focus ***really*** needed to be! If my theories proved to be true, this, unfortunately, could mean that so many children could still be non-verbal, because once again, we had attempted to view their world through our eyes instead of attempting to view it – through theirs!

***Surely, if this was indeed the case, I could certainly understand why so many would still be “non-verbal”. Indeed, if I were a child attempting to focus on “the mouth” to decipher language and each time I did that, someone “grabbed my head” or provided some type of “negative reinforcement” to have me focus on “the eyes instead”, then, surely, the very behavior modification methods that were intended to help these children – could indeed be resulting in “learned helplessness” and the simple “giving up” on the part of these children to “break the code”!***

As I considered all this, I could not help but feel that as therapists and parents around the world focused on phrases like “***look at me***” and “eye contact”, that there were probably many, many, children who wished they had the ability to scream: “***No... you look at me!***”

If one considered the fact that girls were primarily “right brain”, that appeared to mean that girls would process information primarily based on “the whole” as opposed to “the parts”. The one area that had been shown to be an exception to this was the processing of “faces” – in this area, ***girls used primarily their “left brain”*** as opposed to their right brain. As I considered this, I wondered... if indeed there did exist “gender differences” in terms of “severity”, could this “left brain verses right brain” issue, at least to some degree, help explain these differences?

Truly, it was evident to me that “severity” of the disorder was a very subjective thing because to determine “severity” you had to look at various factors in terms of brain processing. Clearly, boys could be better in some areas and girls in others. As such, any “severity study” would be greatly skewed in terms of those areas of strength or weakness generally associated with each gender. For example, girls were generally better at social and communication tasks than boys. As such, to measure “gender differences in severity” based on certain functions that were clearly known to be better in girls would most likely skew results to show “girls were less impacted”. Yet to perform a “gender severity study” using tasks such as mathematics – an area generally believed to be stronger in boys – would perhaps, indicate girls were “more severely impacted” by autism. Obviously, one could greatly sway the results of such studies based on “what was included in the study”. Clearly, boys could be more severely impacted in some areas, and girls in others. But, what could explain “gender differences”?

In book three, Breaking The Code: Putting Pieces In Place! I had explained how the brain of a boy was much more immature at birth than that of a girl and as such, boys were more susceptible to trauma resulting from exposure to vaccine toxins, etc. – and, hence, this certainly appeared to help explain why so many more boys were impacted in terms of “numbers”.

Yet, when looking at “severity issues”, if indeed girls generally processed information using more “right brain” functions – and as such – should be processing information more based on “the whole” than the parts, I could not help but ask myself: “How could one have an understanding of the whole without first understanding – the parts that made up the whole?” Everything I had seen in my son indicated to me that Zachary very much needed to understand “how the parts fit together” to understand the whole.

***I truly wondered how all this fit together. Could it be that boys although they needed to understand the “parts to understand the whole” had a better ability to come to that understanding because they were more “left brain” focused and that girls saw “the whole” but lacked an understanding of the parts because, primarily, they processed “wholes” and as such, had a greater difficulty “with parts”? This certainly was all very interesting indeed, and if this was indeed the case, this certainly would have major implications in terms of how we taught these children!***

In working with Zachary, providing ***verbal*** (auditory) explanations for him had always helped Zachary understand not only ***his*** emotions, but ***emotions in others*** as well. As I provided

“auditory” or verbal explanations of “emotions”, I usually provided “word associations” and “motions” that went along with that in order to help Zachary “categorize” emotions. Word associations, after all, were but a form of categorization, and as such, again, this provided that critical “bridging function” between the frontal and temporal lobes. Again, the following were words I had previously written on this subject:

***“As with everything else, with emotions, all sensory input was but a part to the whole. Thus, things were either “this way or that”... the part was either there or it was not... the sensory input was either there, or it was not – everything was an “all or nothing” in terms of the “stimuli” perceived via all the senses... and as such, this explained why even in emotions, too often, everything was an all or none too! Aggression was either there, full blast, or it was not present at all. Anger was either there as complete anger, or it was not. Sadness was either there as complete sadness, or it was not. Joy was either there as complete joy, or it was not. Frustration was either there as complete frustration... or it was not!” [book 2]***

***“In July of 2002, while we were visiting many of my in-laws, almost all my nieces and nephews were playing together... all except Andrew. He went around, talking to himself - undoubtedly a form of ordering language in the older autistic child - and every once in a while, he would notice something another child did, something he thought was funny. What hit me right away on this particular day, was the fact that what Andrew had “perceived as hilariously funny”, most children would have perhaps only found “somewhat amusing”. Yet, there was Andrew, laughing hilariously at something that really “was not that funny” to begin with.***

***By this time, I had already figured out that partiality processing was an issue for the autistic child... but, what I had not realized until that very moment, was that partiality processing affected absolutely all aspects of the autistic child's life... including emotions! Once again, it all made perfect sense!***

***Andrew did not understand the “in between” emotion or “partial emotion” much as he could not understand the “parts” in anything else until they were first “explained” or “labeled”. As such, I came to quickly understand that for the autistic child, even “degrees of emotion” had to be labeled!***

***As with so many other things in the life of the autistic child, we had made the mistake of assuming a child could at least “see all levels” of emotions, but for the autistic child this was a very false assumption! The fact that various “levels of emotion” were expressed every day by those all around the autistic child did not mean that the child necessarily “understood” those emotions, those degrees of emotions within a specific emotion. I would argue, indeed, that the autistic child did not understand “in between” emotions until they were specifically taught. Only then, did I believe, could the autistic child truly come to perceive “levels or degrees of emotion”... only then could he understand the “parts” or “degrees” to the whole - the type of emotion!***

***This easily explained not only issues with “hilarious or inappropriate laughter” so often seen in autistic children, it also explained the other extreme of emotions too - the violent outbursts***

*of anger and aggression. In autistic children, it was all too obvious that it seemed to take "almost nothing" to upset them tremendously. Again, there was no "in between"...the autistic child was either "not upset" or "tremendously upset", "not finding something funny" or finding something to be "hilariously funny"... and nowhere were "degrees" of either anger or happiness anywhere to be found!*

*I now truly came to understand that in order for the autistic child to "perceive" and understand the various "degrees" of emotion - in all types of emotion - those "degrees" literally had to be taught via labels and explanations.*

*The various or "in between" degrees of "happy", for example, needed to be taught to the autistic child since he knew no "in between" emotions. The autistic child was either happy or not happy, sad or not sad, angry or not angry. In my opinion, the autistic child experienced only the "full blown" emotion or none at all.*

*As with everything else in the child's life... the part to the whole had to be defined to be understood...and again, this was why labels were so critical for these children in coping with their world. As with everything in the autistic child's world, when the parts could not be understood, they were simply ignored, or frustration surfaced and erupted in the form of anger and aggression, self injurious behavior and withdrawal and so many other "coping mechanisms" we saw in these children.*

*Given this, how did you go about teaching "degrees" of emotion?*

*As with so much in the life of the autistic child, this too, had to begin with a label. For example, in teaching "degrees" of happy, the autistic child needed to be given labels and specific examples of the following ideas or "levels" of "happy": giggling, snickering, grinning, contentment, enjoyment, pleasure, satisfied, ecstatic, elated, overjoyed and so on. The goal was to teach the various "degrees" or "in betweens" ... between the "a little happy" and "very super super, absolutely ecstatic happy". Once the child understood the various "labels" for the "in between" levels of "happy" or "mad" or "sad", he could then himself, make use of these emotions because now, each specific level of emotion, each "degree" of emotion had been given a label ... making that "degree" or "part" to the emotion an entity in and of itself as opposed to a "part" to something else. Emotions should no longer become outbursts - in any direction - happy or mad - as labels to variations of one thing should provide a coping mechanism and greater understanding of the "range of emotions" for the child.*

*In teaching a child to deal with anger and/or frustration, it now became necessary to show him the various levels of anger... to show him that "it's ok to be a little angry if this happens, but not very angry"... to show him what level or degrees of anger were appropriate for various situations. So was it true for levels of aggression. Autistic children needed to be shown what was acceptable "emotion" and "behavior" and what was not - given a specific situation. The same would be true of "levels of screaming"... when was a little scream ok... and when was it ok to give out a huge scream! All these "levels of emotion" had to be taught to the autistic child! :o)*

*Teaching the child to cope with his emotions via productive [coping mechanisms](#), [discussed in detail in book 2] and helping the child understand alternatives to emotions, the "in between" emotions as opposed to only the extremes, I was convinced would be of great help to these children in anger and aggression management.*

*I knew Zachary has some appreciation for the expression of emotions as seen in these pictures when asked to show me his "happy" and "sad" face.*



*But, in teaching him, I previously had never thought about the "in between" in emotions... at least not until recently." [book 2]*

Obviously, this certainly appeared to be a great deal of work, yet, once something was taught and understood, it made life much, much easier – for everyone!

I had also recently started to explain to Zachary what was appropriate in terms of “what could be experienced” for a given situation since I knew that again, he had no reference points in terms of “what was appropriate emotion for a given situation”. Thus, I taught him not only degrees of the emotion itself but degrees of “what was appropriate emotion”. For example, I explained to him things that made “mommy happy”, things that made “mommy very happy”, things that made mommy “very, very, very happy” and so on as I gave him concrete examples of each. Likewise, I explained to him things that “made me upset”, things that made me “very upset”, things that made me “very, very, very upset” and explained to him that for example, “dropping your ice cream cone (cfcg) was upsetting – but only a little bit – that you should not get very, very upset because of that”... that you could “just ask for another one”.

***It was always key to explain “the alternative” to Zachary when he became upset... and to simply explain to him that “he had options” not only in terms of “experiencing the emotion” but in terms of “dealing with it” also!***

***Thus, providing the “in between” again was key – as was providing “options”!***

The one area I had found extremely difficult in dealing with “appropriate emotions” and the “associated response” definitely had to be the emotion of “fear” as it related to matters of safety. I discussed this issue at great length in both books two and three and strongly encouraged all

families to read this information. The part I had failed to understand when it came to “safety” and “fear” was that “fear” could apparently, only be experienced by stimulating the amygdale. That certainly could help to explain why so many of these children seemed to “experience no fear of danger” if my theory of limited or no communication among the various parts of the brain were correct. Fear of danger had to be “specifically taught” to Zachary. Zachary was finally making progress in this area, but it had taken a lot of work involving word associations, categorizations, etc.

In addition, I had always found that “negative emotions” were much, much more difficult for Zachary to deal with – be those emotions in himself or in others. As such, I became very attentive to his emotions and was quick to respond when Zachary experienced emotions I considered “negative” – emotions that usually resulted in stress for him. The easiest way to deal with these was always by using something involving the sense of smell (i.e., treat) or categorization functions. If certain toys or objects became too stressful, they were simply removed and put away for a while and taken out again at a later time. Just diverting Zachary’s attention, via games involving motion for example, was always helpful. Zachary absolutely loved anything that involved motion in play – especially when verbalizations (auditory processing) were also used. For example, if we engaged Zachary in play, just the motion of “tickle fingers” coming his way was enough to get him very excited, as was the rubbing of one’s palms together as we said: “I’m going to get you”.

If the situation was one of rather intense stress for Zachary, I would also use a lot of good old hugging and “sniffing” to calm him down. There were times when simply saying “let’s go make a cocoon” was enough to calm Zachary down as we went to hug, rolled up in or just hiding under a blanket. Zachary had the video “The Very Hungry Caterpillar” by Eric Carle and I had once noticed him “making a cocoon” in order to physically comfort himself in the past. As such, this became an easy way to provide actual physical comfort for him – a way he knew that he could simply “get away” and relax by literally separating himself from the rest of the world. Other tricks that worked well to give him “quiet time for himself” involved “building a house” out of blankets and furniture. These were all things that even a normal child enjoyed. As time went on, we needed fewer and fewer of these things, but I always kept them in mind – “just in case”.

Word associations were easy ways to deal with negative emotions too. I had a few key phrases that, at least for now, still worked amazingly well. For example, if Zachary was “whining” or crying, a simple “stop whining or go to bed – which one?” was usually enough to get him to stop “whining”. Only once or twice had I made Zachary take a “time out” by lying on his bed – telling him he had to stay there until he calmed down. Zachary had not liked that at all. There was no tantrum but he certainly did not enjoy the boredom of daytime bedtime. The thought of “going to bed” during the day was “not normal” and as such, it was something he preferred to avoid since “going to bed” was only for “night time” – as he clearly indicated when he stated, “no, not time for bed” – yet another example of “reference living” as discussed in greater detail in both my second and third books.

Motor activity (i.e., making a cocoon), word associations and control of emotions were all co-located in the frontal lobe, and as such, again, it made perfect sense to me that the methods I used to help Zachary deal with stress had worked so well. Given the fact that the body used B6 to

produce epinephrine to deal with stress, and epinephrine was a muscle stimulant it thus made sense that “motor activity” – something involving muscles – had to be a way by which our bodies naturally helped us cope with stress and as such, motor activity to control emotions made perfect sense.

Ultimately, I knew that Zachary had to come to an understanding of how to alleviate stress by himself – how to prevent the stress from happening in the first place. In order to understand his world, I knew Zachary had to understand how the parts to the whole fit together and as such, labels had helped tremendously in alleviating stress. Zachary was finally at the point where he understood that if he had trouble understanding something, all he had to do was ask: “what’s that?” and that which he did not understand would be explained to him.

I quickly came to realize that for Zachary, simply saying “no, don’t say that” or “no, don’t do that” was not enough. I had to add that extra to provide for him the reference he needed. Thus, if I said “no, don’t say that...”, I had to add, “you say...” to give him what was the “appropriate” or desired response instead. To just say “no” without providing the alternative did very little for children like Zachary as that provided no future reference to draw from for an appropriate response next time around. As such, unless the alternative was provided – the appropriate reference – in my opinion, one could easily keep going over and over the very same issues and spinning one’s wheels in frustration without realizing why *a simple “no” was not enough for the child with autism*. *In my opinion, the same was true for not only verbalizations but for behaviors as well. As such, to tell a child like Zachary “no” when it came to inappropriate behavior did nothing if the reference as to “what to do instead” was not provided along with the “no”. Of course, the more “references” in terms of “what to do instead” – the better!*

There finally came a time when I had realized that *my* providing the labels was not enough – Zachary had to come to learn to ask for the labels he needed – *himself!* As such, I now gave Zachary more instructions in terms of how to deal with stress. I had told him, for example, “If Zachary does not understand, Zachary just says “what’s that?” and mommy will help Zachary understand”. *“Just say, what’s that...”* or *“Just ask for help by saying - help me mom -...”* became key phrases I used with Zachary to provide *instructions for him as to what he should do* to help himself “decode” his world and help himself deal with stress. *Instructions included “what to do”, and also what “not to do”*. For example, I would say: *“Don’t get upset... just ask for help”... “say, mom, I need help...”*. Once Zachary understood that, again, life became much, much easier – for everyone.

*Given control of emotions was co-located in the frontal lobe with word associations and motor activity, it was obvious to me that these were the critical keys in helping to best control Zachary’s emotions. As such, I began to have “key phrases” for specific emotions.*

For dealing with frustration: “It’s ok... just start over”, “try again...”, “sometimes, that happens... just try again”, etc.

For dealing with anger: “It’s ok... just let it go” – as I used motions to show the “let it go” part of the phrase by extending my arms away from my body.



For dealing with sadness: “It’s ok... I love you... let’s be happy...”. I also used favorite treats, motion, phrases involving things he liked to do, such as “let’s draw a green truck”, or “get your puzzle” or “let’s make a picture with lots of colors”, etc. Anything I knew helped Zachary to “de-stress” was a hint as to what to use to help control his emotions.

For dealing with excess excitement: “That’s great... let’s keep going”, “ok... let’s watch what else happens...”, or “what’s next?”, etc., were phrases that helped focus on “the future” or “looking ahead” or “the next step” to prevent Zachary from getting so completely wrapped up in the moment of excitement that it became so intense it interfered with teaching.

I found that helping Zachary anticipate what was “coming next” was also very helpful with transition issues. For example, in teaching Zachary, if he was becoming disinterested, a simple: “let’s finish this page and then Zachary can take a break” was often enough to help him complete the task. Not surprisingly, Zachary soon learned that when he reached his saturation point, he himself could say: “I need a break...” and that was my cue to give him a little rest for fifteen to thirty minutes before going on to the next lesson.

To cope with changes in routine or changes in plans, I explained, “what was coming” by providing the appropriate chronology. For example, I would say: “First we are going to ... second, we are going to... third, we are going to... .. is that ok”. By providing an “**outline that involved chronology**” for activities to come, Zachary was better able to deal with stress and changes in plans. I found that I could also easily ask and obtain Zachary’s forgiveness for changing plans. After providing the chronology, I would say, for example: “sometimes, plans change... forgive me... do you forgive mom for changing plans?”. This simple phrase made Zachary realize that at times, we did need to do things differently than originally planned but that it was ok to do so. Given I usually kept a favorite treat in the car to help control Zachary’s emotions, if I sensed any distress at all due to the “change of plans” and the “chronology explanation” was not enough, usually, providing both the explanation and the treat together (i.e., a “tic tac”) was enough to keep Zachary well under control when it came to changes in plans.

In my opinion, understanding the workings of the human brain and how to control emotions was especially important for children with autism given these children lived “via reference”. In my opinion, anything they saw, heard, etc., could become a reference for future use.

Unfortunately, not all “references” – things seen or heard – were “good references”. These children could truly be a product of their environment. Of course, one’s “environment” could include many, many things, such as the influence of violence on television. As such, I did not allow Zachary to watch programs that involved violence. Granted, I knew there were many who would say that you could not shield a child from such things. Perhaps. However, I also very much knew that “these types of references” – until he understood more in life – were references that at least for now – Zachary could very much do without!

I cautioned parents to be very, very careful of the words they used with their children. For example, words like, “you’re stupid” or any other negative verbalization, in these children, especially, although also very much true for any child, had the potential to clearly devastate and destroy a child emotionally and psychologically. I urged parents to remember that the

“parroting” in their children, especially in such verbalizations, were not “mindless or nonsense language” but, truly, perhaps more accurately, a reflection of - the parent – or of those things a parent allowed to enter a child’s life via television, and yes, potentially, abusive caregivers!

Parents finding themselves asking: “where did he pick that up” as they listened to verbalizations from their children with autism should truly look for “the source” of any troubling verbalization in their child – because if a child with autism was verbalizing such things that was due to a very definite reason! Likewise, given my belief that these children lived via reference, in my opinion, physical violence directed at either these children or someone else was also something that they very much could “learn” and “reproduce” – as was true of other, “normal” children also.

Increased aggression was a sign of temporal lobe damage, but, it was also, very much a reflection of one’s environment – of that – I had no doubt! A child’s environment today included much more than just “the home”. It included school, after school programs, babysitters, errands to the store, visits to the dentist, athletic events, tv, radio, etc. There were, truly, many, many “sources of input”. Children mirrored in their words and actions what they saw and heard – and this was, in my opinion, also very true of children with autism!

Given that motor activity, memory as it related to motor activity, motor planning and execution, word associations, and control of emotions were co-located in the frontal lobe – along with concept of self – there was simply no denying that this was the reason children were, often, a reflection of their environment! There was an old saying that stated: “Actions speak louder than words”. Given the above, that certainly was true. The only words that could be “just as loud as actions”, “were word associations” – because like motions – or actions – “word associations” were co-located in the frontal lobe along with language production and motor functions. As such, a child was very much defined not only by actions, but, by the words used to define him – and that held within it tremendous potential – to either build up a child – or completely destroy him!

The implications of this in my opinion, spanned far beyond autism. For example, this certainly could help explain why women who were abused by their spouses still remained with them, in spite of possibly having their very lives in jeopardy. Word associations, such as “I love you” when combined with abusive behaviors, certainly made for a dangerous situation indeed, especially given that emotions (sadness, hurt, etc.) were located in another part of the brain and as such the word association and motor activity would have a stronger impact on a person than would the recall of the memory associated with a bad experience – such as spousal abuse.

Note that obsessive-compulsive behavior was a sign of frontal lobe damage – the very area associated with motor activities and word associations. Note also that this part of the brain involved motor activity as it related to “habits” – and abuse, certainly could become – “habit”.

As such to overcome issues of spousal abuse, or child abuse, a person (both victim and offender) had to be taught to properly “categorize” word associations and actions. Word associations, motor functions and sense of self were co-located in the frontal lobe. Categorization functions and emotions could be found in the temporal lobe. Many functions dealing with “emotions” and the integration of “emotion type input” occurred in the amygdale.

In my opinion, one of the keys to helping individuals in situations such as spousal abuse was clearly in the categorization of word association and actions in order to best help one understand the situation. The understanding of language (or the situation), categorization and emotion, were all functions co-located in the temporal lobe along with face and voice recognition – and most importantly, the ability to distinguish between truth and a lie! Interestingly, goal directed behavior (i.e., the need to get away from an abusive situation) was located not in the frontal or temporal lobe, but in the parietal lobe – a completely different part of the brain. When one considered all these issues, clearly, the need for proper communication among the various parts of the brain was paramount.

Fortunately, although the power of negative words and actions was clearly there, so too, was very much the power of positive words and actions for a child. In my opinion, there could never be “too many I love yous”, too many kisses, or too many hugs. If there was one thing we had always worked very hard at showing Zachary, it was that he was very, very much loved, and very, very much wanted. Games like “my boy”, where all family members physically “tugged” at various limbs in an attempt to “keep Zachary” and have possession of him, had always been a favorite for Zachary. Like any child, he needed to know, without a doubt, that he was loved and wanted.

Since Zachary loved letters, I had recently made it a point to show him that he had an “M” in the palms of his hands. As I showed him that “M”, I said: “***M is for mommy’s boy***” to indicate that he had that “M” in his palms to show he belonged “to me”. As soon as I had said that, Zachary smiled, but then, I saw a little “concern” in his face, because he only had “Ms” in his palms – no “D” for “daddy’s boy”. I quickly grabbed Zachary’s bare foot and with my finger, showed him that the arch of his foot made a “D” and that his “***D for daddy’s boy***” was on his feet. I could see the joy in his little face as he realized he once again belonged “to both”.

Since we had also been working on proper pronoun usage, I showed him that “one M” in his palm was for “mommy’s boy” and that the other was for “***M equals me***” to provide for him a constant reminder – a physical reminder - that ***in his hand***, was ***a mark indicating “who he was”*** – that this was “***me***” – ***not “you”*** – the pronoun children with autism often associate with themselves because of the fact that they were referred to as “you” by those who spoke to them. I also added, “***M equals me equals my equals mine***” to help reinforce the key pronouns associated with one’s self so that Zachary would have a clear reference indicating that pronouns referring to “him” were pretty well all those that started with “M”. I had also worked a great deal at adding “***when Zachary is talking Zachary equals I***”. This was a simple way to use “recognition of body parts” in the understanding of language – both functions located in the temporal lobe!

The issue of pronoun confusion, in my opinion, was not only an issue of “speech” and proper grammar, but very much an issue that had the potential to either build or destroy the concept of self in children with autism. There was simply no denying that as Zachary came to also better understand who “he was” in relation to others as a result of work I had done with him on proper pronoun usage, that his person, and hence, his emotions – overall – became much, much happier. This critical topic – pronoun confusion in children with autism - would be covered next.

## Pronoun Confusion... And The Loss Of Self...

Below were words I had previously written in another book on the subject of pronoun confusion and how something that appeared “so trivial” could have such major implications when it came to understanding not only language, but understanding one’s concept of self as well. The area of “pronoun confusion” was such a critical issue to both language and the concept of self, that I replicated in full a section from my third book below. Persons who had read my third book, *Breaking The Code: Putting Pieces In Place!* could simply skip over this section, although pronoun confusion was so critical to the concept of self and other materials in this text that I strongly urged all parents to read this short section – even if only “review” for some.

It was a well documented fact that persons with autism, schizophrenia and Alzheimer’s had difficulty with the use of pronouns – words such as “*I, me, and you*” – especially - appeared very confusing to them.

In my opinion, “pronoun confusion” could very much be explained by the need for labels in everything in persons having these disorders in order to help them “break the code” – to help them understand their world.

Given that, it was perfectly understandable that those with these disorders would have difficulty with pronouns. ***Pronouns were "labels" that changed based on who was doing the talking.***

For example, take the question: “***Does this belong to me or you?***” It was when I had asked Zachary this question that I truly came to understand the issue with pronouns. If I pointed to myself as I asked that question, I labeled myself as “*me*” and if I pointed to you as I asked that question, you were labeled as “*you*”. ***Those were "the labels" given when the question was asked.*** I was labeled as “me” and Zachary understood himself to be labeled by me as “you”. So, in answering the question, if Zachary used “these labels” as provided via my “pointing” when I asked the question. In answering, it would make perfect sense that even though he knew that something belonged to “him” that he would use the pronoun “you” to answer the question, because in pointing to him or simply “asking the question”... “you” had been used to refer to “him”.

***As such, in answering the question, Zachary had answered: “To – “you””. In answering this way, Zachary was not telling me that the object belonged to “me”, he was telling me that the object belonged to “him” and using the label I had provided in the question – the label for Zachary being “you”. Zachary understood the object belonged to “him” but answered “to you” because “you” was the label “he” was given in the question.***

***I tried this simple exercise over and over with Zachary, and sure enough, the response was always the same – in answering he would use the pronoun that had been used “to designate him” when the question had been asked!***

***Thus, the issue of “pronoun confusion” was one of a "moving target" since pronouns changed based on who was doing the asking and who was doing the answering.***

Any such "moving labels" or "moving reference" – a "moving target" - in my opinion, would thus, understandably be an area of difficulty for Zachary – a child trying to make sense of his world based on "labels" for specific things – and in this case – the labels were not constant – they changed or "moved" based on who was talking. Certainly, this had to be very confusing for Zachary and in my opinion, ***what would appear to be something so "trivial" to so many – proper pronoun usage – in reality, I believed could have a very detrimental effect on the concept of self if not properly understood by Zachary!*** Just as "pronouns" were moving targets – so, too could be the concept of "self" when pronouns were not properly understood and "me" and "you" were somehow lost in the "shuffle". Truly it was critical that persons with these disorders understand the proper use of pronouns in order to prevent further loss of the concept of "self".

It was important to work this issue because it was more than just a matter of "proper pronoun usage" – of proper "grammar". Truly, pronoun usage was also very much a matter influencing the concept of "self" and proper pronoun usage in my opinion, was thus, critical to solidifying the concept of "self".

In order to help Zachary with issues of pronoun confusion, I did the following:

***The easiest way to start was to take a simple sentence like: "I love you". I took my hand and put it on me while I said "I love" and then, when it was time to say "you" I made sure my hand was on Zachary. I then said "And... you [with my hand on Zachary] love me [moving my hand back me]. Then, I said, "Ok, now it's your turn" and then I took Zachary's hand and made him do the same motions/sentence so that he now took the role of "I" and "me" and I became the "you".***

***"I love – you – and you – love – me".***

Such a simple sentence – with such a powerful message in more ways than one!

I also made him use his finger and put it on one of his body parts - like his nose - and had him say: "This is **my** nose". I then put his finger on my nose and had him say: "This is **your** nose." Then I did the same thing and I assumed the role of "my".

When I interacted with Zachary, obviously, I did most of the talking and as such, when referring to Zachary, what he had heard quite often, most of his life, was Zachary being referred to as "you" – by others around him. I had, in the past, more often referred to Zachary as "Zachary" in my speech, but I knew that had not been true of others around him. Thus for his entire life, Zachary had heard "someone" refer to him as "you" on countless occasions. It had only been very recently that I had noticed "just how badly" Zachary was confused when it came to pronoun usage and hence I worked on this issue – only – for several days in a row and tried to make sure ***I always corrected improper pronoun usage. In my opinion, that was absolutely critical.***

I took Zachary's hand and I put it on his chest as I said: ***"When Zachary is talking about Zachary, Zachary says I or me or my or mine". Then I added, "I = me = my = mine" in order to provide for him all the pronouns – the many labels that could refer to - "himself".*** Much as

in the case of the “peg” system with math, I wanted to provide for Zachary as many “options” as possible for his understanding that there could be many ways to refer to “himself” – just as there could be many ways to come up with the number ten. Note that I also used “math equations” to help Zachary “classify himself” because understanding of language and categorization were co-located in the temporal lobe and as such, I believed that for Zachary to properly understand the concept I had to make use of “categorization” and that meant using “equals”. The same principle applied in the formation of word associations and the concept of “self” – co-located in the frontal lobe. Note that by using my hands and placing them on “I” or “you” I was also making use of motion – also co-located in the frontal lobe along with word associations and the concept of “self”.

Obviously, the "***When ZACHARY is talking about Zachary***" was *the important point to get across here* because, in order to get to proper pronoun usage, *Zachary had to understand that some pronouns were "tied" to the person doing the talking* so, that was the part I really made clear in teaching him this.

When I explained this to him, I emphasized with my voice the part of "***When Zachary is talking about Zachary***". I also said "***When Zachary is talking, Zachary equals I = me = my = mine***". Those were the exact words I used to help drive home the concept.

I then told him that "***When mommy is talking, mommy equals I = me = my = mine***". I did this *to show him that the "I, me, my or mine" changed based on who was doing the talking.*

***I then put his hand on me and said: "When Zachary is talking about mommy, Zachary says you or yours"***. I did the same thing for "other people too" - like other family members and during the day, I asked Zachary to finish the following: "I equals..." and he completed it with "me". I would then prompt with the word “equals...” to have him also add the word “mine”, and then again I would prompt with the word “equals...” to have him also add the word “my”. I made sure he had all four words – all four pronouns that could refer to “him”. Thus, Zachary had to understand that “I = me = my = mine”.

***Finally, in order to make sure Zachary really understood that “pronouns changed based on who was doing the talking”, I said: “ok... now, let’s both say it”... and we simultaneously said the phrase “I love you and you love me” with each one of us placing our hands appropriately based on the “I” or “you” or “me”. This helped to further solidify for Zachary the concept that either he or I could be the “I”, “you” or “me” and that it changed based on who was talking. I would also “show Zachary” who was talking as I motioned and said: “I’m [putting my hand on my chest] talking to you [pointing to Zachary]”... and then added “ now you do it...” Zachary loved anything having to do with motion, and thus, motion worked particularly well in teaching pronoun usage.***

I also showed him the use of "other pronouns" by saying: "You plus me = us", or “You plus me = we”. Note again that math equations were always used. I could then carry that to talking about someone else. For example, in talking about Anika (his sister), I told Zachary: "If Zachary is talking about Anika, Zachary says you = she = her" and so on. Again, the key was to get

Zachary to understand that ***pronouns changed based on who was talking***. Zachary used to be absolutely horrible at pronouns.

I had always found that Zachary responded best to “Zachary” and as such, most often, during our interactions, I had referred to him not as “you” but as “Zachary” in the past. It had only been as I researched so many issues about autism, schizophrenia and Alzheimer’s and saw “pronoun confusion” as an issue in these disorders that I truly began to notice that this – indeed was an issue for Zachary.

***It truly was not something I had specifically worked on until very recently only because I had not really noticed it and had no idea that such a simple concept, if misapplied, could so contribute to the destruction of his sense of self!***

Zachary’s use of pronouns was now much better than it had been in the past. He still had a little ways to go, but he had definitely made some major progress in this area in just a matter of a few days since this had been all I had worked on for several days in a row. ***From then on, I also made sure I corrected any improper pronoun usage with the correct “pronoun equation” emphasizing the “when Zachary is talking”.***

I must admit, I never would have imagined that pronouns could be so confusing! When I first started working with Zachary on this issue, I found it very, very frustrating because it was so easy to “mess up” and use the wrong pronoun as I switched back and forth between “you and me” to make him understand the difference. But, figuring out the “pronoun equation method” early had helped tremendously. ***When in doubt as to how to do something or when I experienced trouble in teaching a concept, the first option I pretty well always looked at now was to somehow “build equations” to help Zachary understand a concept and to literally tell him what to say by saying: “Say....”.***

In our household, the “building of equations” to teach concepts was something we did in many, many things. I used this concept to teach synonyms, antonyms, etc. simply by using “equals” or “not equal”. Zachary had a good understanding of the word “opposite” and thus, I could say “opposite of” also in teaching many concepts.

As confusing as “pronoun usage” could be and as frustrating as I had found it that first day to teach Zachary proper pronoun usage, clearly, understanding the problem was always the first step in addressing it and amazingly, with the use of equations, Zachary had grasped the concept rather well in a short period of time.

Simple sentences with two pronouns were really the best to start with - like the "I love you" sentence using hand motions to help reinforce the concept. By using the "I" verses "you" and the hand motions – together – that helped categorize the pronoun/person relationship. ***In my opinion, it appeared that the “categorization and understanding of language” – co-located in the temporal lobe - were being drawn on in conjunction when I used “equations”, but that “word associations” and “motions” - co-located in the frontal lobe – along with the concept of self – were being drawn on when I supplemented with “motions”. As such, I was activating several key parts of the brain at once as I worked on these “pronoun usage issues”***

*– part of the brain that involved the concept of self – the very thing I was attempting to solidify!*

*As with everything the key was always in first understanding the problem, then providing the proper reference or label and working at providing as many variations of the same thing as possible while trying to make use of as many functions in the brain as possible! Co-located functions were key – as were “bridging functions”! :o)*

In my opinion, it was critical to always "draw" on other functions in the same area of the brain as well as other parts of the brain. I truly believed that would help generate new neural connections within the brain in order to somehow “reconnect” activity/communication among these various parts of the brain.

These simple exercises could go a long way. I could start to work on them first thing in the morning as we hugged and that was a very nice way to start the day. :o)

Although so much of this certainly seemed so overwhelming... with a little practice, it really got much easier.

It was as I worked with Zachary while we hugged in bed, as I carefully listened to his every utterance in an attempt to understand the workings of his brain that I had come to understand so many issues in Zachary’s world.

Undoubtedly, pronoun confusion, could certainly contribute to another issue – matters of discipline in children with autism, for if I child understood not who “he was” in relation to others, again, his world could certainly be one of utter confusion!



## Difficulties In Discipline...

Although I had now trained myself to observe Zachary's every move, his every utterance, his every glance, much of what I had come to understand about autism, quite frankly, had been as a result of conversations I had with my sister-in-law - Christine – also the mother of a child with autism.

Christine had gone through a great deal with Andrew. Andrew had been misdiagnosed for years. He had also undergone heart surgery as a young boy and like most children with autism, he had tremendous difficulty in making friends. While Andrew was in school, it became obvious that he was falling further and further behind and as such, Christine had decided to school him at home. Under his mother's care, Andrew thrived. There was no doubt that with his mother, he was learning more than he had in school.

There were still major areas of difficulty for Andrew, however, as there were for Zachary, and that, as was so often the case, resulted in elevated levels of stress for everyone. When the stress set in, it was time to "talk it out" and that was usually when Christine and I called one another – to share experiences – to share frustrations – and yes, even to share a laugh!

Christine had been so completely devoted to her children. Her daughter, like mine, was "normal" and was approximately the same age as my little girl. Thus, Christine and I shared a great deal in common and we often talked about "our sons" or "our daughters" as we shared our experiences, our frustrations and our joys.

On this particular morning, Christine had called rather early. It was a beautiful spring morning, yet, as I picked up the phone when Chris had called and she had said: "hello", I could sense in that "the day is only starting and I'm already exhausted" tone in her voice and that – need to talk...

"I just don't know what I'm going to do... It's as if Andrew can't tell the difference between a child and an adult...", she stated.

"What do you mean?", I replied.

"Well, I'm just having a really, really hard time with discipline lately", Christine had answered.

Andrew was approximately 12 now – just entering those turbulent teen years – and his mother knew that discipline or maintaining a sense of "control" was important in teaching and providing direction for a child – especially in a child with autism who had shown initial signs of increased aggression during times of frustration – something, that unfortunately, was not uncommon in children with autism. This appeared to be even more of a problem for some of these children as they entered puberty. Christine had indeed become an expert at controlling her son. If Andrew erupted in frustration, she could always "bring him back" fairly quickly and "make him understand the situation".

Note that at puberty, the brain underwent tremendous reorganization and pruning. Increased aggression was a sign of temporal lobe damage – something I very much believed could be happening in these children with the onset of puberty. This issue was discussed at length in my third book, *Breaking The Code: Putting Pieces In Place!* and in my second book also, *Breaking The Code To Remove The Shackles Of Autism: When The Parts Are Not Understood And The Whole Is Lost!*

Our conversation continued...

“It’s as though Andrew doesn’t understand what is appropriate for a child and what is appropriate for a parent...” Christine went on to say. “For example, if I tell him he can’t watch television or something, he thinks that means no one else should be allowed to watch television or listen to the radio, or play on the computer... If I tell him he has to go to bed, he thinks I have to go to bed too... it’s like he can’t differentiate between what is appropriate for him and what is appropriate for me...”

“The other day, we were talking and Andrew said to me: ‘Will you just be quiet for a minute...’ You know, if he said that to me in public, I’d have all these looks from people thinking “how can you allow your kid to speak to you that way... that kid needs a lot more discipline...but, he just can’t tell the difference between what’s appropriate for him verses me...”

I laughed a little as I listened to Christine in her moment of frustration. “Chris... don’t you get it? It’s because these kids live by reference” I replied. “Andrew just thinks that what is appropriate for him is appropriate for you... he’s heard you say, “will you just be quiet for a minute” when you need to speak and say something, so to him, that’s just a way to have you be quiet so that he can speak. He just doesn’t understand that “that phrase” is ok for a parent to say to a child but not for a child to say to a parent... these kids live by reference Chris... so, when you use that phrase, you provide a reference for him... and now, he’s just using it on you... he’s just “parroting back” or using his “reference” of what he knew had worked for you in the past when you needed to speak... he just figured that if that phrase worked for you, it should work for him when he needs to talk too... It’s the same thing with the behavioral stuff... to these kids, everything is a reference... if something is appropriate for one... it is appropriate for all... until they are taught why that isn’t the case...”

“Jeanne, do you know how hard that is... How are you supposed to discipline a child when he can’t tell the difference between what is appropriate for a mother and what is appropriate for a child?”

I laughed. “I understand exactly how hard that is, Chris... but, you just have to teach him the difference... until he is literally taught what is appropriate for a child and given an understanding of why something that is appropriate for a mother to say may not be appropriate for a child to say, and until you ***give him an alternative reference to use*** when he needs to speak, he won’t know the difference... just teach him what he should say when he wants to talk and make him understand the issue or concept of discipline and why it is important for children to listen to their parents... I know it’s hard... but that’s what you have to do... in both his speech and behavioral issues... It’s not that he is being disrespectful, Chris... he’s just using the references he has...

that's all... what he hears you say, he'll say... what he sees you do... he'll do... because he lives by reference... everything in his world, everything he sees or hears from you or anyone else... on tv... on the radio... everything becomes a reference for future use with no distinction or judgment as to what is –appropriate... that's why I think changes in environment are so hard on so many of these kids – a change in environment is a complete change in references... see what I mean? ”

“Well, yah... but this sure doesn't make it any easier... can you just imagine the looks I'd get from people if Andrew told me in public... “Will you just be quiet”... people would just be flabbergasted to hear a child talk to his parent that way and then, they'd think I'm letting him get away with it because they wouldn't understand the situation...”, Chris answered. “I'd be seen as a parent that totally lacked discipline... and *you* know that's not true...”

“I know, Chris... but, if you think about it... actually... it is easier once you understand the issue... because now, you know what you need to do to address it... society just doesn't understand these kids and what their parents have to deal with...” I said.

Chris laughed. I could sense the relief in her voice now that she realized this was just a shade of the same issue – what I called “*reference living and reference communication*” – and not an issue with her son being “defiant”.

She and I both knew now that if our sons said: “no, you listen to me...” it would not be because they were not listening or were being openly defiant of us but rather, it would be only because they would be repeating or using a “reference” of what they would have heard us say to them.

**Understanding this issue of “reference living” and “reference communication” in children with autism was absolutely critical, in my opinion. It brought great sorrow to my heart as I thought of the many, many children with autism who had undoubtedly been viewed as “defiant” and in all likelihood punished as a result of this “perceived defiance” – when in actuality, I believed they literally were simply so completely – misunderstood – when it came to issues of “reference living”!**

***I urged all parents of children with autism to be very, very cautious in the area of discipline because, if indeed I were correct, the implications of all this, were truly overwhelming – especially given that due to the very fact that I believed these children lived “via reference” – any discipline provided would also very much, in and of itself become “another reference”. Thus, if a child understood not what he had done that “was wrong”, and was “disciplined” for having done something he did not perceive as wrong – that, potentially, could send a very, very negative message to these children – that perhaps, it was alright to “discipline” for no apparent reason – and if that “discipline” involved physical means – the implications of that were very serious indeed for a child who, I was more and more convinced, lived very much – by reference!***

***Understanding issues of discipline – for both parent and child – and the need for both to understand these issues – as they related to “reference living and reference communication” – was – absolutely critical to all! I certainly was not saying that a parent should not discipline a***

*child when necessary. What I was saying, however, was that a parent had to have a very good understanding of why the child had done or said what he did and whether or not what was said or done was but a reflection of a “reference” the child had previously been given. The key to discipline in children with autism such as Zachary, I believed, was in teaching them what was appropriate for a parent and what was appropriate for a child – for a given situation – and in teaching them why there existed a difference between the two in the first place. Patience and understanding – absolutely key when it came to discipline for – the child, and, - perhaps more so – for the parent or caregiver (i.e., teacher, therapist, etc.)!*

I knew Chris to be a very, very patient and loving mother. She too had poured her life and soul into her son. Her journey had been a much more difficult one because Andrew, for so long, had been so misdiagnosed and Chris, like so many other mothers, had been so completely alone in trying to understand her son – a son, she too, loved so very, very dearly.

I had always been so fortunate in having Christine to go through the trials of autism with me. Through Andrew, so often, I had been able to “prepare” for what I should expect “down the road” as Zachary got bigger. I had learned so much about autism not only from Zachary but, from watching Andrew also and from talking to Christine. It had been because of the immense difference in “knowing what to expect” that I had so wanted to share our family’s journey with other families – to provide for them what Christine had provided for me through her trials and frustrations and most importantly, through her countless and invaluable observations. Like me, Christine was now noticing so many of those little things in her son that previously, would have perhaps gone completely unnoticed – those little things that so often held the keys – to so much!

The issue of discipline certainly was one that involved so, so many aspects of life. Communication, diet issues, behavioral issues, etc. – all of these fell under the umbrella of “discipline”.

Not long ago, Christine had called her brother, my husband, to let him know a neighbor had accidentally died – a very young man, with four small children – a young man my husband had known all his life. Often, Christine only spoke to her brother and then I was later “filled in”. This death had very much upset my husband as this was a young man who had worked so hard for his family – and now – totally without warning – he was gone and his family certainly could face very difficult times ahead. Frederick very much suspected this young man would not have had life insurance – that insurance would not have been something he could have afforded. I could see the news of this death weighed very heavily on my husband. After we spoke of Bobby for a while, I asked Frederick “what else” his sister had said as I usually did after one of their many long conversations. Christine phoned often as we phoned her often also – to share a laugh – or, as in this case - sorrow.

At times, it was mainly Frederick who spoke to his sister... at others times, it was I. We just “took turns” and Christine knew that whomever had spoken to her that day would “fill in” the other person. Whenever Frederick told me about his conversations with his sister, he was always careful to include anything Christine had said about her son Andrew given he knew I would be very interested in that information. On this particular day, Frederick had told me that Christine had taken Andrew to a naturopath – a person who preferred to use natural ways of

healing the body. Andrew, a boy very much on the autism spectrum (pervasive developmental disorder) was now twelve years old. This particular man had suggested that Andrew avoid casein, gluten and sugar. Well... needless to say, I was not surprised. Zachary was already casein and gluten free – as were many, many children with autism. Andrew had been misdiagnosed for so long that by the time his family realized the issue was “autism”, he had actually already developed verbal skills and was interacting with his family. Zachary, however, had been very much in his own world and removing the casein and gluten had made a world of difference in his life.

There were many other issues, that in my opinion, could have helped to explain Andrew’s speech development – such as “the mystery in the right temporal lobe” and the possible implication of anesthesia in speech development in children with autism as a result of temporal lobe damage. Anyway, the point was that because Andrew had developed communication skills that had, in part, contributed to his being misdiagnosed for a very long time. As such, Christine had never placed him on a casein/gluten free diet... and now, here she was, being told Andrew should avoid these things as well as sugar.

Andrew certainly did not have that “drugged out look” that Zachary had once had. Andrew was very alert. All this made me wonder about how much – time alone – could heal in these children. Zachary had now been casein and gluten free for just over three years. And he was doing fantastic progress. Andrew was doing well in some areas (i.e., very good conversation skills), but, in others, he certainly seemed to struggle more than did Zachary when compared based on skill level for attained age in certain areas – especially mathematics. Zachary was only six and he seemed to be just about at the same level as Andrew – now a boy of twelve. Thus, I suspected putting Zachary on a casein and gluten free diet could have been a contributing factor as to why Zachary now did so much better in mathematics than did Andrew, but, I had no way of knowing for sure.

A casein and gluten free diet was rather overwhelming to implement at first – but, for us, it had been the right thing to do and I knew that in my heart. As difficult as I had found it, at first, I knew that for Christine to implement such a diet now, with a twelve year old boy who had very much enjoyed the “variety of foods” – including “offensive foods” such as casein and gluten – would be a challenge indeed. It was because of this that so often, it seemed parents tried to do a “partial diet” – removing either only casein or gluten – one at a time – to see what that would do. Parents on discussion boards often stated that just removing “casein alone” had shown to be a significant help for their children.

The thing that had somewhat concerned me, however, was that Christine had been told to avoid almost sugar – including processed sugars and many natural sugars as well – especially from things like orange juice.

It had long been believed that “processed sugars” made children much more hyperactive. And, from a behavioral standpoint, that certainly would not be “a good thing”. As such, I very much understood the reason Christine had been advised to avoid “processed sugars”. Zachary received very, very few processed sugars in his diet. The only source I could think of off hand would be from the jam we sparingly put on his rice bread toast.

Most sugars in Zachary's diet came from natural sources – things like honey. Zachary ate very little in terms of fruits. He just simply did not care for them. Every once in a while, I also gave him natural chocolate – maybe a square centimeter or two at a time – that was usually “the most” he would get in a day”.

I had long struggled with the issue of “sugar” in Zachary's diet. Yet, I knew it could be a potential issue for behavioral problems and as such, make “discipline” a little harder.

And, I also knew that sugar contributed to yeast growth in the intestinal track – and that yeast overgrowth was a huge issue for many children with autism and that it create an improper balance in the digestive system. Controlling yeast issues had also very much been an issue for us and as such, I had given Zachary cranberry juice pills (from Kirkman Labs) in the past to help with that. I had found those to be rather expensive however, and so, I switched to a very inexpensive but, in my opinion, effective product that I could purchase at any local health food store – grapefruit seed extract.

**Note: Grapefruit seed extract should never be given to anyone who has heart problems or is on medication of any type without first consulting a doctor as it can cause serious, serious complications.** Grapefruit products – all kinds – seem to have the ability to “magnify” the effects of medication. Thus, even though an “over the counter” item, this one, for heart patients, could be very dangerous. It was because of issues like these that I urged parents to consult their physicians in the care of their children – especially when adding new supplements – because you just never know. I had always been fortunate in that my father, a doctor, was only a phone call away if ever I had any questions.

Olive leaf extract, oregano oil and garlic were other products parents of children with autism often used to help with “yeast issues”. Note that many of these products were very expensive and tasted horrible – even just a few drops – and that was often all that was needed each day. But, even a few drops could be a battle to give to a child when the product tasted “so strong” and/or “so bad”. Thus, I was very painfully aware of the “sugar issue” in children with autism. But, I was also very much aware of “another issue” when it came to sugar – the other side of the coin in all this.

Low blood sugar was very much associated with seizure activity. Knowing that children with autism often developed seizures as puberty, I simply could not find it within me to remove “all sugars” from Zachary's diet. As such, I gave Zachary “some sugars” but tended to stay with “natural sugars” – like a little honey on rice toast, etc. There was a lot more on this issue of epilepsy and seizures and autism in my third book, *Breaking The Code: Putting Pieces In Place!* – a book I urged all parents to read carefully.

As such, yes, there were “discipline issues” that could certainly be impacted by diet (things like sugar, food colorings, preservatives, etc.), but there were “other issues” such as seizures that also had to be very much kept in mind when it came to children with autism. Parents wanting to learn more about “diet issues” could find a lot more on this topic of “diet” for children with autism in my first book, *Saving Zachary: The Death And Rebirth Of A Family Coping With Autism!* There were also many parent discussion boards on diet for children with autism. Diet

issues were very much discussed, for example, on the Yahoo Group entitled enzymes and autism. The focus of this group was “enzyme supplements” to help break down casein and gluten – but – all types of “diet issues” were discussed here also. Parents could join this discussion group at the following link: <http://groups.yahoo.com/group/EnzymesandAutism/>.

My best advice to parents when it came to matters involving diet, was to be as informed as possible and do your homework. I knew my son, Zachary, but he was the only child I knew. As such, it was important all parents take responsibility for their children’s diets and supplements – and that meant, talking to your doctors – and also, very much – understanding the issues in the first place because if there was one thing I had learned over the years, it certainly was that the majority of doctors still did not seem to truly understand the many issues surrounding autism.

I had been given very little reason over the years to trust the medical community. Yet, truly, my distrust of the medical community had its roots not with doctors – because I knew most doctors did their best for their patients. My distrust of the medical establishment was rooted much more in a very huge distrust of the NIH and CDC – because now, without a doubt, I knew they knew of the many issues surrounding vaccines and of the dangers of neurodegeneration due to mercury exposure – as clearly stated in the Simpsonwood meeting transcripts – and still, all we saw from the CDC was denial in this issue of vaccines causing neurodegeneration.

The simple fact was that doctors also, trusted the CDC and the pharmaceutical industry to do what was right. As more and more doctors came to understand these many issues, I suspected they too, like me, would feel very, very betrayed by the CDC, the NIH and the pharmaceutical industry – those “supposedly doing the research” and producing the products on which so much in healthcare depended. Doctors not only depended on these organizations for direction, but for “continuing education” and if these organization were not truthful with parents – and did not admit or face the issues publicly – I had no doubt that they also did not admit the issues to doctors. My father had so trusted “the system” also. He had so loved medicine and still did. It was the politics of it all that he had always had a very difficult time dealing with – and that was true now, more than ever.

As such, I urged parents to help inform doctors of these issues by providing them with reports such as the Simpsonwood transcript and telling them about the University of Calgary video on neurodegeneration, etc. In my opinion, doctors were also very much victims of the CDC and NIH in all this... and all too often, they were the ones facing lawsuits when children were injured as a result of “their care”. Doctors acted as “informed intermediaries” and as such, they could very much be held liable for vaccine injuries sustained by children – after all, doctors were supposed to be “informed in these issues” – they were “the professionals” – they were supposed to have done their homework. Yet, when doctors were also lied to by the CDC and the NIH, how could they possibly be held accountable when injury resulted due to mercury, aluminum, and/or iron toxicity cases or injury that resulted perhaps from viruses themselves – as in the case of the MMR!

Thus, although I personally had had a very difficult time trusting the medical establishment, my intent certainly was not to tell families not to go to their doctors. Rather, it was to tell families

to seek the advice of their doctors – while making very sure that these doctors were truly informed as to the many issues surrounding autism. Granted, many were still learning. But, if there was anything a parent could do to help educate a doctor in these issues, by providing things such as those mentioned above, then, in my opinion, it certainly was the responsibility of parents to do so. To assume the CDC would do this, in my opinion, would be a very bad assumption to make! The pharmaceuticals and government had attempted in the fall of 2002 to seal vaccine injury lawsuits from the public – that had certainly been for a reason!

Truly, matters of “discipline” as they related to “autism” spanned far, far beyond the parent and child relationship because it certainly appeared to me that there needed to be a little “discipline” provided to those sitting in the halls of the NIH and – especially - in the halls of the pharmaceutical industry and the CDC!

Before leaving the issue of discipline, I had wanted to provide for parents an insight on something I had seen recently for discipline in children with autism – this time, not in the area of diet, but in the area of behavior therapy.

This system for behavior modification in children with autism consisted of color-coded prompts. That idea – the use of color codes for something that was acceptable or not – was something I thought could actually work – especially with very young children who had “gotten away” with less and had “fewer references” to draw from in terms of what was acceptable or not. Of course, the reason I believed a “color coded system” could be of value was because I had seen the importance of color in Zachary’s life over and over again.

I had only very briefly looked at the materials provided on this particular website. Yet, in looking at these materials only very briefly, there was something that had captured my attention and concern immediately. The “concept” of color-codes for discipline, I absolutely felt could indeed work for these children. However, it only took “one bad reference” to send what could be, in my opinion, a very, very negative message... not in terms of actual discipline but in the area of communication.

This indeed, was the issue I struggled with. The materials had been put together to help with “discipline issues” – yet, what I saw, raised serious concerns in the area of “communication issues” in children with autism. As such, I did raise my concerns by sending an email to the author of these materials... because, again, I felt the concept was excellent – it was just “one card” I had seen that troubled me greatly.

**Fortunately, my email received a quick response and the person who had replied to my concerns, indeed agreed with me that my concerns were valid and as such, “the card” was pulled from the Internet site!**

Let me now explain “my concern” with this “one card” and the need to raise a “red flag” in this matter because clearly, issues of communication and discipline were very, very much inter-related.



This particular card was for “unacceptable behavior” and as such, it was coded red. At the top of the card was a short sentence telling children “not to talk during a certain time”... the picture below that text included was a picture of two children, with one emitting “sound waves” toward the other. On top of the two children talking was a big red “X” to indicate that talking was “not acceptable during this particular time”.

Now, herein was the issue. Many children with autism were clearly “non-verbal”. Many children with autism also did not know “how to read”. As such, in my opinion, the text at the top of the card could almost be “useless” unless the child knew how to read and understood the message being given – exactly. It was my belief, however, that for many children, that message would not be understood – exactly – and hence – herein came my huge concern.

If a child had limited communication skills, a card such as this, in my opinion, could easily send a message of “no talking” – and that message only – that “talking was not acceptable”! This was clearly NOT the message parents wanted to be giving to children who already faced great obstacles in expressing themselves. As such, although the card had been made for a “discipline lesson” – something these children absolutely needed in order to provide for control in the “learning situation” - clearly, the “communication lesson” within that card, in my opinion, had the potential for relaying a very, very negative message to a child with autism.

Personally, given I knew “motor functions” and “word associations” were co-located with the production of language in the frontal lobe and that “categorizations” and auditory processing were co-located with the understanding of language in the temporal lobe, I felt that to use something like a “sign” in sign language for “silence” on the card would be a much better message to send than a “no talking” message.

I, too, had learned something from my email exchanges with this woman. Originally, I had planned on using “red ears” in my appendix materials/exercises dealing with “listening”. However, as I thought about this, again, I, too, could be giving exactly the message I did not want to be giving to children with autism with something as simple as my “color choice” for ears.

I had stated time and time again that I believed colors played a huge role in Zachary’s life. Of that I had no doubt. Clearly, he also knew that “red = stop” and “green = go”. Likewise, in this behavior therapy program, “red = non-acceptable behavior” and “green = acceptable behavior”. As such, for me to use “red ears” in order to try to “draw attention” to the ears in my pictures – although a nice visual “for me”, clearly, for a child with autism, I could easily have been sending a message of “no listening” or “stop listening” with my “red ears” – exactly the opposite message to what I wanted to put across. As such, I decided to change “my listening ears” to “green ears”. The difference was perhaps, viewed as “subtle” by many, but, it was those subtle hidden messages that could be very detrimental or counter-productive.

In the area where I lived, there was a family nearby who had a child with both autism and Downs Syndrome. This child was approximately eleven years old. When I had first spoken to the mother about my theory of language production and the fact that it was co-located with motor functions, and mentioned to her that I felt that had to be why some of these children responded to

“sign language”, she stated: “That must explain why he stops dead in his tracks when I do the sign for STOP”. I did not know this family that well and had no idea that she used a few signs from sign language with her son. This child had only a handful or so of picture cards that he used to communicate with his family. He also had yet to be potty trained. I knew that Downs Syndrome and autism had to be inter-related, especially since I now knew that a “dual diagnosis” of autism and Downs Syndrome was no longer considered rare. Indeed, the “dual diagnosis” was now a topic of discussion at International Downs Syndrome conferences. I very much suspected that iron had a role in this “relationship” between autism and Downs Syndrome. I provided more on this issue in my third book, *Breaking The Code: Putting Pieces in Place!*

Thus, with this child also, my theories seemed to be proving accurate. Of course, all this was just “my theories” on why something worked or did not work in the area of language in children with autism. But, personally, I could never take the chance of being “correct” in the issue of **this particular “discipline card”** with my son. **Thus, again, the concept, in and of itself, of using “color codes” for acceptable or non-acceptable behaviors in disciplining a child, in my opinion, was excellent – it was just this one “communication issue” in particular that I had a huge issue with in terms of the message it could potentially put across to these children and, this one issue alone - for me - was huge!**

Needless to say, I was extremely thankful when I received a message stating it had “been pulled”. I had only briefly reviewed these materials – but, again, I certainly could understand how something like this could indeed work based on what I had seen in my own son when it came to colors. For those interested in this “color-coding system” for behavior modification, these materials were available at: [http://www.redandgreenchoices.com/Sample\\_Materials/8.htm](http://www.redandgreenchoices.com/Sample_Materials/8.htm).

**Again, my issue had only been with “the one card” – the concept itself of using colors in discipline – I felt was excellent... and, in the end, I had very much seen that I, too, could potentially have made “the very same mistake” in communicating exactly the opposite of what I intended to communicate. It would have been that easy to provide such a potentially negative message! As such, this certainly had been a learning experience – for both of us!**

As such, I too was grateful to Irene of “Red And Green Choices” by “Green Irene” for helping me to catch in my materials – before they had been seen by anyone - the very issue I had been raising in hers! :o)

The “horse before the cart” issue further complicated this matter of discipline and communication. Those who focused on “discipline” or “behavior modification” tended to see that as absolutely key and hence, to them, the focus was “discipline” and that had to come first if you wanted to be able to communicate with a child with autism and “get anywhere”, and there were those who argued that “communication” had to come first before there could be discipline. I was of the opinion that communication had to come first. Ideally, they had to almost come simultaneously, but unfortunately, that did not appear to be possible... and as such, it was of no surprise to me that “matters of discipline and control” could be so very difficult at times for parents of children with autism – especially, when combined with such issues as this, issues that could be so very subtle that they could so easily be missed by persons having the best of intentions!

## Failing Schools? Failing Teachers? Or... Failing Materials?

The issue of how to best teach a child with autism was certainly one all parents of children with autism struggled with. There was absolutely no doubt that discipline or “control” and communication went hand in hand when it came to the learning situation.

Just as my sister-in-law Christine had made the decision to home-school her son with autism, so too had I taken on the role of teaching Zachary. There was simply no denying that I best understood my son and best understood his every utterance and gesture. Although I realized there were basically no curriculums designed specifically for children with autism, I still had to have an understanding of “what” to teach Zachary in terms of what was “appropriate” for his age. Wanting to make sure I at least covered “the basics”, I ordered a homeschooling curriculum for first grade.

So, there I was – materials in hand – ready to teach my son. I knew Andrew had done much better when taught at home in terms of academics than he had done while in school. Naturally, there was a tendency to assume that if children were falling behind in school – especially special needs children – that, “the problem” was - “with the teacher”.

Well - now - “I was the teacher”. As I worked with Zachary, I soon came to very clearly understand why it was that we now had so many “failing schools”. Granted, there was a great deal more to learn today and that alone surely had to play into the equation somehow. Yet it was not that teachers had gotten that much worse or rather that there was “too much to learn too quickly” – but rather – the materials provided to students today simply failed to explain – the basics – the concepts! There were many, many examples of this I could provide. I knew that for Zachary to understand anything in his world, he had to understand the parts to the whole to then understand the whole – he had to understand how the pieces “fit together” and that meant he – especially - had to understand - “the concepts”. Given how important “concepts” were for all children, not only children with autism, I wanted to provide for parents very concrete examples of these issues.

Take for example the simple “concept” of determining “which number is bigger”.

Zachary was an excellent counter. He could now “keep counting” quite high. He also knew how to count by tens, by fives, by twos – both odd and even, etc. He was also starting to grasp how to multiply numbers and, indeed, knew almost the entire “three times” table to “twelve times three”. Zachary had just turned six in August of 2003.

Zachary simply adored counting. This made perfect sense to me given he very much needed order in his life and needed to understand “patterns”, etc. in determining how things “fit together” or worked.

Well, as I enthusiastically pulled out my materials for grade one mathematics, I quickly realized that teaching certain concepts was going to be a lot more complicated than I had originally thought – and this concept of “which number is bigger” was certainly one of those “concepts”.

Zachary's materials included something like this...

Instructions were given to put a circle around the numbers that were “bigger than X” – “X” representing a specific number. So, for example, the exercise could involve putting a circle around any number bigger than 39. Well, that certainly sounded easy enough – yet, Zachary, a child who loved numbers, had great difficulty with this simple exercise. So, as with everything, I looked closer as I tried to determine – “the problem”.

In no time at all, “the problem” became very apparent. Below was a reproduction of something similar to what Zachary needed to do.

**Put a circle around the numbers that are bigger than 39.**

<b>34</b>	<b>28</b>	<b>73</b>	<b>22</b>	<b>14</b>	<b>91</b>	<b>69</b>
<b>39</b>	<b>56</b>	<b>06</b>	<b>40</b>	<b>88</b>	<b>38</b>	<b>102</b>

Zachary was then required to do the same type of exercise for “smaller than”.

In looking at this simple problem, I originally had thought, Zachary would “breeze” through this stuff... this was “so easy”. Wrong!

As I watched Zachary start to make circles, I quickly realized that he was circling everything. It appeared as if he was simply “not understanding” that only “some” numbers could be circled. But, then, I looked closer! Zachary was doing exactly what he was being asked to do – he was circling the “bigger” numbers.

Note that the ***“Instructions” were written out in smaller font and hence, every number in the box was “bigger” than 39!*** As such, Zachary's answers were correct – based on visual input!

***Yet, if asked verbally, if 34 was bigger or smaller than 39, he could easily give me the correct answer. Thus, verbally, and conceptually, he understood the concept – visually – it was completely missed! The reason the concept was missed visually was because, quite frankly, the concept had not been taught. The materials had moved immediately into “examples” or “exercises” and had completely failed to teach the basics – the concept itself – that was taught elsewhere in a section not even remotely close to this one – and indeed – a later section!***

This particular exercise seemed to “just assume” that if you could count to about one hundred (100), you would know the numbers that “were bigger” and that the “visual cue” of “smaller

numbers” in the instructions would not have an impact in what the child perceived as “correct answers”. Well, this certainly could not have been further from the truth – at least not in Zachary’s case.

Granted, one could argue that the exercise had “purposely been done that way” to ensure the child understood the concept and did not go “just based on physical size” of the actual numbers. This certainly raised a very interesting issue – was Zachary more of a “visual learner” or an “auditory learner”?

Clearly, when asked “verbally” Zachary could usually provide the correct answer – he understood “the concept” and applied it properly. Yet, when provided with “this visual”, he had completely failed the exercise – over and over again! So – did that make Zachary a “more visual learner” – in my opinion, the answer to that was – no!

The simple fact was that the “concept itself” had not been grasped here – visually – yet it had clearly been grasped when using auditory cues/questions.

***In addition, it was interesting to note that auditory processing and the understanding of language (i.e., instructions) were co-located in the temporal lobe. As such it made perfect sense that auditory learning or teaching of the materials provided for “better results” in Zachary. Only visual perception of faces, places and body parts was found in the temporal lobe with the understanding of language – not exactly things that were useful in this particular exercise!***

Again, certainly, one could argue that the materials had purposely been made that way to ensure the child actually understood the concept. While, there was no doubt in my mind that this could very well be true, the fact remained that Zachary had not grasped the concept but rather had only been “fooled” by the visuals and the fact also remained that the materials provided only “examples or exercises” – and had still failed to teach the basics – the concept itself!

If anything, “the concept” had been, in my opinion, destroyed by the visuals – not enhanced. The goal of learning, after all, was to help children understand “concepts”! Thus, visually, Zachary had easily been fooled and failed miserably in this exercise, yet, from an “auditory perspective”, he had passed rather with flying colors – and hence – once again, my belief that Zachary learned better when “auditory means” were used. For Zachary, this simple concept had been very, very difficult indeed to teach. The visuals fooled him all the time!

Note also in the above example that the concept of “equal to” was also an issue given the number 39 was also found in the box. “Equal to” – another “missing concept”. Thus, although the materials attempted to teach “bigger than”, “smaller than” and “equal to” – they failed completely in teaching or explaining any of these concepts! Right from the start, the cart had been placed in front of the horse – and there could be no moving forward until things were placed in their proper order – especially not for a child whose very world, whose very understanding of everything was so very, very much based – on order and understanding how “the parts” fit together to form “the whole” – “the concept”!

Alright, so this homeschooling thing was going to be a little more complicated than I had originally thought. I would simply get “better materials”. We had a wonderful store nearby that provided all kinds of schooling supplies – you could order almost anything through this little store. It was a store managed by a woman who had taught school for decades. I thus went there in search of “better materials”. To my surprise, there were none to be found. Math books simply failed miserably to teach even the basic concepts – they all provided “cute pictures” and “lots of colorful or fun examples” – but basically – very little in terms of teaching actual concepts!

Materials could provide a hundred examples of this same exercise – or they could provide a hundred examples of calculus – or geometry – or algebra – but, until the concepts were taught – examples were useless and the child was basically left to figure things out – for himself – or the teacher was left having to do a lot of “extra work” to teach “the basics” – the concepts – that had so often seemed to so miserably failed to be taught in the actual materials! Overwhelmingly, the theme in “teaching materials” appeared to be “cute examples – but no concepts”!

Well, that was slightly discouraging. As I spoke to my husband about this issue, I stated: “Well, I’m just going to have to come up with my own materials where those I bought fall short”. I had no idea just “how bad” things really were when it came to “teaching basic concepts” in schooling materials! I literally found myself spending many, many hours coming up with “my own materials” for Zachary. Interestingly, although it could take me a long time to come up with what I needed, once I had what I believed taught “the concepts” – Zachary grasped them and moved forward quickly.

Below was a reproduction of what I had made to teach Zachary the basics of “bigger than”, “smaller than” and “equal to” - to teach Zachary – the concept and help him “get over” the fact that he was so easily fooled - visually!

Note that there were two parts to this. The first provided a visual representation of the concept along with key phrases. I knew that just being able to get the right answer verbally would not be enough for Zachary – he also had to be able to understand “the concept” and apply it using “visuals”, too!

The second part provided the same “key phrases” but not the “visual” and as such, this second part could be used for “practice” to make sure Zachary completely understood the concept without “extra visual cues” provided in the first example. I made sure I also instructed Zachary to “keep counting” past 119 to show Zachary that “this did not end” at 119... that the same concept could be applied as you “kept going” or “kept counting”.

This issue of “visual learner” verses “auditory learner”, again, was absolutely key to the learning situation and in my opinion, parents had to look for “those things” that best allowed the child to learn the concepts and generalize them. I knew Zachary to learn very well from an “auditory perspective”. Surely, other children may very well be “more visual” in their learning – however – the thing I advised parents to constantly watch for was whether or not the child was learning concepts visually – or being fooled easily and not seeing the concept because of the visuals provided. As with everything in teaching any child, materials were absolutely key and had to

“put across” the proper message – or else – materials could quickly become very, very counter-productive and indeed, waste a lot of time – and energy – two things that were so very precious to parents of children with autism!

My best advice to parents was always to keep in mind that if something did not look like it was working, perhaps another approach was necessary. To keep using a failing approach, in my opinion, was senseless – especially in a child that had some verbal skills because that indicated the child understood the basics in communication. Thus, if “still failing to get it”, it was probably “the approach” that was failing in communicating the concept properly!

Note: Although I could easily have made these in a “smaller size”, I wanted to provide for parents two separate pages, as I used them as I felt that was “more useful” for those who wanted to teach this concept as I had done with Zachary. I simply put these two pages back to back in a plastic sheet cover and that way, I could easily go back and forth between the two and still keep them clean. There was no denying, that even with “these visuals”, Zachary still had a little difficulty grasping the concept – visually – but, I think he finally “had it now”.

0	1	2	3	4	5	6	7	8	9
10	11	12	13	14	15	16	17	18	19
20	21	22	23	24	25	26	27	28	29
30	31	32	33	34	35	36	37	38	39
40	41	42	43	44	45	46	47	48	49
50	51	52	53	54	55	56	57	58	59
60	61	62	63	64	65	66	67	68	69
70	71	72	73	74	75	76	77	78	79
80	81	82	83	84	85	86	87	88	89
90	91	92	93	94	95	96	97	98	99
100	101	102	103	104	105	106	107	108	109
110	111	112	113	114	115	116	117	118	119

**Just keep counting higher and higher...**

**The higher you count, the “bigger” the number...**

**The number “after” is always “bigger”...**

**After = Bigger = More Than = Greater Than**

**Before = Smaller = Less Than**

**Equal = The Same**



0	1	2	3	4	5	6	7	8	9
10	11	12	13	14	15	16	17	18	19
20	21	22	23	24	25	26	27	28	29
30	31	32	33	34	35	36	37	38	39
40	41	42	43	44	45	46	47	48	49
50	51	52	53	54	55	56	57	58	59
60	61	62	63	64	65	66	67	68	69
70	71	72	73	74	75	76	77	78	79
80	81	82	83	84	85	86	87	88	89
90	91	92	93	94	95	96	97	98	99
100	101	102	103	104	105	106	107	108	109
110	111	112	113	114	115	116	117	118	119

**Just keep counting higher and higher...**

**The higher you count, the “bigger” the number...**

**The number “after” is always “bigger”...**

**After = Bigger = More Than = Greater Than**

**Before = Smaller = Less Than**

**Equal = The Same**

Note that I provided synonyms for Zachary to help define “greater than” or “less than” or “equal to”. In providing synonyms for Zachary, I always used “equations” or made use of “equals” because the understanding of language and categorization functions were co-located in the temporal lobe and as such, I had always found that the more co-located functions I used, the greater Zachary’s understanding. Thus, in teaching Zachary, I made use of a lot of “synonym” equations when going over instructions – especially if I noticed any hesitation in Zachary’s understanding of “what was needed” in the exercise or his understanding of “what he had to do”.

For Zachary, this was a very difficult concept to learn and he still struggled with it at times – but, usually, he “got it” now. I usually worked with the first sheet only at first. It took several days of practice (perhaps three hours in total) for him to really even begin understanding this concept - visually. Clearly, Zachary’s focus was very much on the physical size of the letters as opposed to the concept itself because he clearly still continued to struggle when we went back to the exercise book. He did much better if we simply worked off my sheets alone.

Once he started to understand the concept based on the sheets I had made, I could simply pull out “sheet two” without the “visually increasing numbers” and ask him for the “bigger” or “smaller” number than X and he would pretty well always have the correct answer. Note, that I also suggested providing “written questions” – exercises that were not provided in auditory means – in order to make sure that the concept was understood by simply reading and answering as opposed to “hearing” and answering. The reason I say this of course, was because auditory processing and understanding of language were co-located in the temporal lobe. As such, if I only “asked” Zachary “which is bigger, 10 or 38”, he could certainly focus on the “auditory” aspect of the question and answer based simply on that and not look at the sheet itself. If I wanted Zachary to start “taking in” visual input in learning also, I needed to make sure that he was focusing not only on what he “heard”, but what he also “saw”. As such, I would suggest to parents that they actually write out a couple of questions on “bigger than”, “less than” or “equal to” and then have the child read those and provide the answers – without auditory input – in other words, without saying or verbalizing the questions – out loud.

In my opinion, it was also very important to be careful of the “order” in which the answers were presented. I found myself, for example, asking the question almost always with the smaller number first and I did think Zachary had picked up on that. As such, it was important to make the answers “more random” or switch the “answer pattern” so that at times the correct answer was first, but at others times, it was second, or third, etc.

There was no doubt in my mind that Zachary was absolutely better with auditory than visual cues in many, many things and I very much suspected this to be true of many other children with autism. As such, I used auditory processing in teaching concepts, however, in order to help him learn visually, visual tools had to be provided to help rebuild those connections that may have somehow been severed. Thus, personally, I taught concepts using a lot of auditory processing, and then reinforced by providing visuals also! Whenever possible, I would also use motion and colors, too – two other aspects to life that I knew were absolutely key for Zachary!

The issue I had with so many teaching materials when it came to “visuals” was that, too often, they were simply too confusing or provided too many distractions. Cute pictures were fine for

“normal” children, however, for Zachary, too often I found they provided nothing more than a further distraction. I found so many materials had “too many cute pictures” but “no concepts”.

For example, in one of the books I had, the exercise involved determining “order” – who was first, second, third, fourth, and so on. In this particular example, there were cute pictures of people in various positions. They all had the same clothing on. Each had a specific number on his clothing – much as you would in a race – and the numbers went from 1 to 10. Of course, given the exercise was to understand if the child understood the concept of “order”, the numbers on the clothing did not match the 1-10 position for the person in the line. Thus, the person with number 5 on his clothing could be in first place and so on.

Well, needless to say, that was very confusing for Zachary. When I asked him who was fifth in line, he of course answered “one” because the first character had a number 5 on his clothing. The important thing to note here was that the concept – once again – had not been taught. Only an example had been provided to “work on”. Once again, the materials assumed the child understood the concept and failed to teach the concept itself.

Given I knew right away what the problem was, I decided to add a number line above the people. I labeled each dot on the number line starting with 0 and going up to 10. Above the 1 on the number line, I wrote the word “first”, above the two on the number line, I wrote the word “second” and so on all the way to “tenth”. I then told Zachary that “1 = first, 2 = second, 3 = third, 4 = fourth” and so on. Once I did that, he much more easily understood the concept of “place in line”. I then drew various animals under a similar number line and asked Zachary to tell me which animal was “fifth” or “seventh”, etc. I then removed the number line altogether and asked him the same type of questions. Finally, I drew people in a row and put names below each one and asked Zachary to tell me who was “fourth” or “second” in line. Again, he could provide the correct answer. Thus, although the pictures were “cute” and colorful in the materials I had purchased to teach Zachary, they had - again – completely failed to teach – critical concepts – and, indeed, for Zachary, the “cute and colorful” pictures had only further distracted and confused him.

Teaching materials seemed to be overflowing with “confusion”. For example, in science materials, all five senses had been discussed. Then, as the child progressed in the materials, he was expected to associate a word with a sense. Some of the words provided were things like “sweet” or “bitter” – clearly words associated with only one sense. But, then, there were words that could be descriptive of more than one sense, yet the child was expected to pick only one correct “sense” as the answer when clearly, there could be more than one sense involved with that particular word. Examples of this included words like cold, slippery, big, square, wet, etc. Clearly, something could taste cold, feel cold and look cold (i.e., outside). Likewise, something could feel or look slippery, or feel or look big, or feel or look square, or feel or look wet, etc. As such, in many, many cases, there truly was more than one correct answer and yet, the child was expected to pick “the correct answer”.

Perhaps the ultimate example in confusion that I came across, however, had to do with an exercise in mathematics that involved the teaching of units of ten. In this exercise, a child was

given a box with items to count. Then, to the left of each box, there were two columns – one for tens and one for “ones”. As such, the page looked something like this:

	TENS		ONES		Answer
This box would have a certain number of items in it the child was expected to count		+		=	
Next box would have something else to count...and so on...		+		=	

Thus, say that the first box had 16 apples in it. The child was expected to place a 1 in the tens column and a 6 in the ones column, and then put the number “16” in the answer column.

Well, there were a few problems with that. If you put a 1 under the “tens” column and then a “6” under the ones column, that can get rather confusing in that it now appears that “1+6” = 16 and clearly, that was not the case. Thus, for the publisher, providing just that “one header” at the top was easier to do, but, for Zachary, this was clearly very confusing – especially since he also knew that 1+6=7. As such, in order to once again teach the concept, I had to do something additional on my own. I decided to add the words “tens” and “ones” just after the “1” and “6” within the boxes as opposed to having the single header at the top.

					Answer
This box would have a certain number of items in it the child was expected to count	<u>  1  </u> tens	+	<u>  6  </u> ones	=	<u>  16  </u>
	so, <u>  10  </u>	+	<u>  6  </u>	=	<u>  16  </u>
Next box would have something else to count...and so on...	<u>    </u> tens	+	<u>    </u> ones	=	<u>          </u>
	so, <u>      </u>	+	<u>      </u>	=	<u>          </u>

I found that to teach Zachary this concept, I also had to make use of physical “units of ten” materials that I could purchase. These showed Zachary how ten ones made one ten, and so on. As such, I had something he could physically count and manipulate with his hands also as I tried to teach him this concept.

This had been a very confusing topic for Zachary. Unfortunately, when working with a child who lived by reference, as I very much believed to be the case, that first reference was absolutely critical and as such, incorrect or confusing references such as what had been presented in these materials had only made the lesson more difficult for Zachary and for me. Not only were the materials truly lacking in properly teaching the concept – they had made it so that now, I had to correct something inaccurate that had been provided as the all critical “first reference”.

To make matters worse, when I turned the page, I saw the following:

	TENS		ONES
This box had a picture of an apple with the number 16 on it	<b>10</b>	+	<b>6</b>
Similar examples followed and the child was expected to fill in the “tens” and “ones”...		+	

Note that the first example had been “provided” for the child. Now, I was certainly no genius, but even I knew that 16 did not have 10 tens in it! Was it any wonder children were having difficulty today? Of course, one could say that this was just “a typo”, but, a typo such as this or lack of attention to detail in what was being taught created tremendous confusion for Zachary – as I was certain it would for any “normal” child as well. I knew many, many teachers. I also had several siblings who were teachers. As I explained my frustrations to them and looked at some of the materials they taught, they simply said, “we see this all the time”. In other words, teaching with materials that provided no understanding of the concepts, jumping right into examples and providing confusing examples were all just “part of life” in teaching. Teachers were then expected to “point out the problems” or provide explanations for things that had been presented badly in the first place.

Thus, not only were the concepts not provided or taught to start with but, teachers were spinning their wheels and wasting their time having to explain why those things that were provided were quite simply – wrong! If this was the caliber of materials provided for teaching today, let me just say that I had “concerns” as to how children were being taught. And then, we had parents and government bodies crying that we had “failing schools” and children who did not understand even the basics and teachers who needed to be “tested” when perhaps, teachers were not the true problem with our schools. Was it any wonder that children were failing to understand the basics! In my opinion, the basics were not taught in many of the materials teachers and students were provided with. Add to that the fact that we had so many more children with special needs, and this certainly all made for one wonderful mess!

The other thing I had noticed in teaching Zachary when the exercise required “circling the correct answer” was that he wanted not only to “circle the right answer”, he also wanted to “do something” with the wrong answers, too. This again, went back to that “all or nothing” issue. I

found that if I simply told Zachary to put an “X” on the “bad answers” that this was enough to alleviate his frustration with “the leftovers” that were not the “correct answers”.

I very much felt that this need to “do something” with “everything” in front of him (i.e., all the numbers in the box) also very much posed a problem in the learning and evaluating situation. I could immediately recognize the issue here – I very much doubted that a teacher would recognize that perhaps the need for the “all or none” played into wanting to circle everything too.

Thus, I knew that it was not an issue of Zachary not necessarily understanding the concept, at times, as much as it could simply be “his need” to “do something” with “everything” – to not leave “any pieces” by themselves or “not part of the whole”. This was an issue I had very much noticed in Zachary when we first started working on this concept. With a little practice, I found he could “move on” without having to “do something” to every number in the box, but, I also knew this was still “an issue” to be dealt with – an issue that would keep resurfacing time and time again in “various shades” due to the very nature of how I now believed Zachary’s brain worked – that need for the “all or none” – and that strong aversion to the “in between”.

To circle “some numbers” and leave the rest alone, by definition, created an “in between” because some were circled and some were not. As such, the need to “do something” to each number was clearly there – clearly an expression of Zachary’s difficulty with the “in between” situation – but, when understood, certainly something that could still be “worked around” and explained in order to – teach the concept – and then, move on! Clearly, there could be no denying that there were two issues here – teaching the concept – and dealing with the frustration of the “in between” – the leaving of “choices” or “potential answers” – untouched. But, in teaching “greater than”, “less than” or “equal to”, my focus had to be on those “concepts”. It had been simple enough to tell him to circle the correct answer and put either a square or an “x” on the wrong answer and then to gradually start moving to “just doing the circles and leaving the other ones alone”. In recognizing the issue with the “in between” or “partials” in life, all teaching now became also an opportunity to help with that issue as well.

When it came to teaching Zachary, I also knew I needed to allow him a little more time to help him deal with these issues of “parts to the whole” when it came to teaching materials. For example, one of his math exercises involved measuring the parts of a house - the roof, the walls, the door, etc. and indicating “how long” each “part” was. Well, this particular house only had the “shell” of the house and a door. There were no windows and no chimney. Zachary very much knew that pretty well all houses had windows and chimneys. As such, he insisted on drawing them in before we could move on to the next exercise. Again, this had to do with his issues with “parts to the whole” and the aversion to any “in between”. A house, after all, was not “complete” without windows and a chimney. Thus, again, in this example there existed an opportunity for working on issues of “partiality processing” and the “in between” situation.

Again, recognizing the issue was always the first step in addressing it!

Parents who were not clear on this issue of “dealing with the in between situation” were encouraged to read all books I had previously written – especially books two and three. There

was a great deal more discussed on this issue in these texts, and the implications of all this, in terms of teaching, communicating with and understanding these children, were absolutely huge.

Another example involving “a house” had to do with an exercise in which only part of the house was drawn. It had a rectangle with windows and a door as well as a chimney – already drawn – and the child was then asked to “draw the missing part” – for the roof. The roof, of course, would have been a “triangle”. Zachary could easily draw “the triangle” to complete the house. However, when I then said, “what shape is that?”, he answered: “a pentagon” because a “house” looked like a pentagon. As such, he was not paying attention to the “current task” involving the triangle (the part to the whole), but rather, now that the “part” had been put in place – the roof – parts no longer mattered – because, once “the whole” was understood, that was now what he focused on – at least for the time being. If asked about “the house” later, and asked “what’s that”, he would identify the object as a “house” first and then break it down into its “parts”. At other times, I noticed he would focus on the fact that there were “four windows” or that it was a “brown house”. As such, colors, shapes, sizes... all these were very critical in how Zachary “saw things”.

I was actually surprised at how long I had to ask Zachary “about the roof”. If I simply pointed to it and said: “that’s a...”, expecting him to say “triangle” given this was a “shapes” exercise, Zachary answered, “that’s a... roof”. Yes, that was correct... it was “a roof”, but, again, the exercise itself – shapes – had now taken a “backseat” to the “real reference” – this was indeed “a roof” to a house – not a triangle. If I then said, “it looks like...”, then Zachary could easily say “a triangle”.

Again, clearly, this indicated that Zachary lived very much “via reference”. A roof was a roof... and that was it... and yes, it could “look like” a triangle if asked that question – specifically.

Another very similar example of this issue with “communication” and Zachary’s “reference living” had to do with “a pig”.

In this particular math exercise, pictures of animals were provided and were to be matched with shapes. For example, there was “a pig” and “a cow” and “a giraffe” that could be used. Next to the animal pictures, there were shapes to choose from to be “matched” to the animal. Thus, you were supposed to match a pig to a circle or oval, a cow to a rectangle, a giraffe to a triangle. When I first did this exercise with Zachary, as we looked at the page, I stated: “A pig looks like a ...”, and then, I, of course, waited for the answer... thinking this would be “real easy” for Zachary... and of course, came the answer... “a pig”. So, yes, Zachary was correct again. He knew from his “reference” that “a pig looked like a pig” – there was that definite “this or that” and “a pig” certainly looked like “a pig” and nothing else. To get the “correct” answer – or at least the one required in these materials - all I had to do was say, “A pig looks like what shape?” Now, he easily answered... “an oval”.

Another example of the fact that Zachary clearly “lived via reference” and needed to do “something” with all possible choices in a question and the impact of this on the teaching or learning situation had to do with an example involving the phonics for the letter “b”.

At the very top of the page in this exercise, Zachary was provided with three “b” words along with a picture for each – boy, baby, and bush. This part of the text did not require Zachary “do anything” other than see these were “b” words.

Next came eight more pictures, only in this case, Zachary was required to circle only those pictures that started with a “b”. These pictures were for the words: bow, bear, bat, bed, box, butter... along with two “incorrect answers”... a shovel and a tree. The problem with the picture of the “shovel” and “tree”, however, was that the shovel had a brown handle and the tree had a brown trunk... and “brown” as Zachary clearly pointed out as he circled the “brown tree” and “brown shovel” certainly started with a “b”, too!

I tried to explain to Zachary that we were not really looking for “colors”, just “things” and that these two things were a “shovel” and a “tree” and hence, they really were not “b” words. Well, Zachary quickly figured out that the picture of the “tree” looked very much like the picture provided just above for “bush” and so, now, that “tree”, according to Zachary, was still something that should be circled because it was “a bush”.

Thus, in this simple example, clearly evident, again, was Zachary’s desire to “do something” with each picture – if a picture “didn’t fit” in an obvious way, Zachary simply came up with a way “to make it fit”. As I looked at this simple example and how Zachary had reacted to it, clearly, I could see his point – “brown” did start with “b” and so both the “brown shovel” and “brown tree” could be correct answers for “b” words, too. This, again, also showed the importance of colors in Zachary’s world.

Another example of how colors had influenced Zachary’s answers when I taught him had to do with an exercise that involved circling things that were “alike”. For each part of the exercise, the typical “three were the same” and “one was different” were given and the three the same had to be circled or the one that was different had to have an “x” placed upon it. In circling his answers, Zachary would very much refer to the colors of the objects.

For example, in one exercise, there was a fork, cup, spoon and knife. Obviously, the one that did not belong was the cup, but, in circling the fork, spoon and knife, Zachary seemed to think they belonged together more because they were all “silver” as he clearly stated, “it’s a silver spoon, a silver fork and a silver knife”. The example immediately following that one again, indicated the importance of colors for Zachary. In this example, there was the brown face of a man, a brown table, a brown chair and a bed that had a brown frame but a blue bedspread. In selecting those items that belonged together, Zachary clearly picked those items that were most similar in terms of color as he verbally stated “the brown face, the brown table and the brown chair”. I certainly would have not understood Zachary’s answer had he not **actually verbalized** the color in determining his answer. It was only as he actually verbalized his answers that I came to understand them. The bed, although it had a brown frame, had much more blue on it than brown and as such, Zachary perceived that as the item that did not belong – even though clearly, the bed, table and chair were all pieces of furniture and hence, the “correct” answer in terms of what did not belong should have been “the face”.



Time and time again I had seen the importance of colors in Zachary's world. I now very much believed that colors were the primary way in which Zachary classified his world. If indeed children with autism were so dependent on colors for understanding their world, then within this was a very powerful tool for teaching these children. Using colors to help "teach" concepts was certainly something to consider. In my opinion, materials should be made to teach concepts using colors to reinforce the "correct" answers and then, as the child came to understand the concepts, colors could become secondary as they could then be "mixed" so that "correct answers" were not always of the same color. Given there were many "shades" of colors and given the fact that children with autism had such attention to detail one certainly could use different "shades" of the same color to teach the concepts first. This would help reinforce the "correct" answers but also provided enough "variation" so that the answer was perhaps not as "obvious" as we may perceive it to be because, clearly, children such as Zachary do not see things simply as "yellow" or "red" but were very much sensitive to "shades" of the same color and as such "all yellows" were not "just yellow" – they were – technically – different.

I had seen this time and time again in Zachary also. Whenever there was a "shade of red" that was perceived as somewhat different, he would ask me "what color is that mom" even though he clearly knew "red" as a color. Thus, although the "normal person" saw "red" or "blue" or "yellow" this was not the case with children such as Zachary – he saw each color very much as an individual and specific color. Clearly, Zachary understood colors to be "similar", but he also understood them to be technically "different" as well – much more than would a "normal" person.

I knew that in school, Zachary would have received a "wrong" for the answers he had given me but clearly, they were not "wrong" when understood from Zachary's "color perspective". He had been able to "explain" his answers and they made sense. For all of two seconds I had attempted to explain to Zachary why these answers were "not correct", but, I soon realized that "I was wrong" in telling him that. Zachary's "references" were accurate – and when I tried to tell him they were not – there came that "unprovoked crying" because his "reference system" was failing him – not because it was "inaccurate" in reality, but because it was "inaccurate" according to someone else's personal judgment. Thus, the "correct answer" was one of determining whether or not to go "by facts" or "opinions" as to "what was correct" – and clearly, that shovel was brown – and so was that tree or bush!

Thus, in order to "move away from colors" in answers, one would clearly have to explain to look at "something different" or "something other" than colors for the answer.

The issue of "unprovoked crying" and "unprovoked laughter" had been addressed in my third book, *Breaking The Code: Putting Pieces In Place!* In Zachary, both of these were clearly tied to his "reference systems" and resulted from either a failure in his "reference systems" – as in the case of "unprovoked crying" or from a new way or reference for looking at the same thing, as in the case of "unprovoked laughter". For Zachary, it certainly appeared that unprovoked crying and unprovoked laughter also had to do with "categorization" functions (temporal lobe) that were disconnected from control of emotion (frontal lobe) and word association (frontal lobe) functions. As such, when Zachary's reference systems failed (i.e., categorizations in his world), or when new references or "alternatives" were understood for past associations or understood to

work in a new, unexpected way that was perceived as funny or “advantageous”, he clearly had great difficulty controlling the emotion that resulted from that system failure or change in reference systems. I provided examples of this in my third book and encouraged all parents of children with autism to read that information also.

The interesting issue in terms of the “brown tree” or “bush” and the “brown shovel” that this brought up, at least in my opinion, was the fact that although children with autism were the ones who had such difficulty with the “in between situations” and hence so often wanted to “do something” to every answer, even though they were clever enough to come up with an explanation for their “now correct answer”, it was often the “teacher” who had the desire for the “all or none” and had a need for things to be “this way” or “that way” when it came to such exercises – and hence, the “teacher”, in this case myself, also had that social fixation on the need for “one or the other” too – again, not wanting to allow for the “in between”! Thus, clearly, we both suffered from the same “problem” in this area – at least to an extent – and I suspected this was true of all “teacher-student” relationships – in general.

Our school systems were clearly based on “right verses wrong” answers and very rarely did we seem to allow for the “in between” – even as “normal” adults – even when the answer given by a child “made sense”, we as adults still tried to show that “it did not” and that it had to be “the expected answer” or it was “wrong” – and that simply was not correct or right!

If society wanted and/or expected “only one right answer”, then adults who were producing these “teaching materials” needed to spend *a lot more time evaluating what to include in their exercises* so that there could be no “other answer” provided by the child. Certainly, those who had put these materials together had not taken the time to really look at what they had done and how a child could respond the way Zachary had.

In my heart, I could not tell Zachary that this was “wrong”, because, clearly it was not. Likewise, to introduce the concept of “a bush” starting with “b” and giving a picture of “a bush” that was basically the same size as the picture of the “tree”, was another serious error in judgment on the part of those who had put together these materials. Quite clearly, that “little tree” could certainly be viewed as “a bush”, and hence a “b” word. Given I knew colors were so critical in Zachary’s life, I very much understood why he had processed information the way he had. *In so much, I had always found that colors were one of the primary ways in which he evaluated information – as was physical “size” – as clearly indicated in the math example above dealing with “bigger than”.*

Another example of this involved the “short a” sound. Again, pictures were provided and Zachary was supposed to circle the pictures having a “short a” sound. Pictures were provided for ham, hat, bat, cap, dog and cow. Again, Zachary focused on “size” and “made a fit” – that “cow” was just a “small picture” and so, it was “a calf” – and that had a “short a” sound, too, and so, to Zachary, that one was right also and only the “dog” needed to have an “x” on it.

Color and size were both fairly concrete – concepts, on the other hand, were rather abstract, and in these cases, color and size had definitely taken precedence in terms of determining the “correct answers”.

In my opinion, given “***colors, shapes, sizes and counting of objects***” were so critical to Zachary, clearly, these had to provide ***critical keys for the formulation of materials for these children***. In addition it was also critical to provide “synonyms” for these children in order to help them understand instructions.

For example, when asked “which one does not belong”, I would say to Zachary that he had to put an “x” on the one that was “too different” and that “too different equals not the same”. That made things a little easier for him, although, again, clearly, there were issues with “reference living” even in that. I tried to make things easier for Zachary in terms of understanding, but, at times, even I found myself having a hard time putting things in a way that was “accurate” and easy to understand. At times, it was quite difficult to achieve “both” – accurate and easy to understand.

For example, in another exercise where Zachary needed to put an “x” on the one that did not belong, this became clearly evident. Three of the four were easy enough in that choices were identical except for the “one that did not belong” and so, those were obvious enough to Zachary. The fourth example on this particular page, however, was slightly different, and as such, Zachary hesitated a little. The example had two small buildings and one very large building. The two small buildings, however, in this case, were not identical. They were different in size, shape and color – although still clearly, much, much smaller than the much larger building. As such, the one that “did not belong” was clearly “the largest” of the three buildings. Yet, I had told Zachary to put an “x” on the one that was “too different” and that “too different equals not the same”. Well, obviously, in this case, all three buildings were “not the same”. Zachary had used the “too different” part of my instructions in coming up with the answer – but, clearly, he had hesitated on this one. My instructions had at least been more helpful than the instructions provided in the book itself – instructions that simply stated “put an x on the one that does not belong”. For Zachary, clearly, those instructions were “not enough” given he had such a tremendous attention to detail and as such, he needed a few more instructions to understand the task.

Providing “***instruction synonyms***” as I called them, had always been a tremendous help for Zachary and those “extra instructions” I provided for him, usually included “equations” of some kind – usually involving the words – “equals” or “opposite of” or “not equal to”.

Note that categorization functions and the understanding of language were co-located in the temporal lobe and as such it made perfect sense that “***equation instructions***” were best understood by Zachary.

Zachary also had a little trouble understanding concepts that involved “things that changed over time”. For example, if asked to circle “things that get bigger” or “things that get smaller” over time, and given pictures of a dog, a pencil, an ice cube, a baby and a plant, he had a little difficulty with getting the right answers. Again, more explanations were needed. For example, if I acted out eating an ice cream cone and said, “does it get bigger or smaller when I eat it”, Zachary could then understand the issue and provide the correct answer.

I think the issue here may have been that in “just looking” at the pictures that provided a very specific reference. What was missing, for Zachary, was the “thing that needed to happen” to

make something get “bigger or smaller” over time. Thus, to Zachary, in looking at “a dog”, it was as though he had just that “snapshot” of the “dog” at “this time” and hence, there was not that inherent understanding that the dog would get bigger over time because the variable of “over time” was missing – all Zachary could see was “the now” – the current “reference”. Likewise, a pencil had no reason to get smaller unless “used” and in providing just a picture of “a pencil”, there was no indication for Zachary that it was “being used” and hence, why would it get smaller – on its own? If I gave Zachary explanations indicating that as you wrote, for example, the pencil was used up and you had to sharpen it to write some more, then he could easily understand that the pencil would “get smaller” over time.

That was of course, only my interpretation of what I believed to be going on in Zachary based on how he had reacted in this particular instance and based on his “greater understanding” of the exercise once I provided an “explanation” of “an activity” that could make “this thing” change over time. Until that “extra force” or “activity” acting upon the “thing” was provided, Zachary seemed to have a hard time seeing how things could “change” – on their own.

Once the concept was understood, however, it was easy enough for Zachary to get the answer later on. Again, it was a matter of teaching – the concept!

I had also noticed in working on “science” issues that those things that involved exercises having to do with “the senses” were absolutely fascinating to Zachary. **There was no denying that things involving “sounds”, “smells” and motion were those things he loved to do best and that explanations of “how things worked” were absolutely critical for Zachary and as such, again these were things that certainly could be used to one’s advantage in teaching these children.**

For example, understanding that sounds were just “vibrations or air waves” was very, very fascinating to Zachary, especially as he could then see that “ripples in water” were “just vibrations too”, etc. Likewise, helping him to understand the difference between “pitch” (equals high or low sounds) and “tone” (equals loud or soft sounds) helped me tremendously during the day. When Zachary’s voice was “off”, I could now simply say: “I want a low pitch, please” or “I want a soft tone, please” and Zachary would respond appropriately. Again, providing a label had been absolutely key in his understanding of the issue.

Likewise, motions were very useful in teaching Zachary. I had seen that time and time again and as such, motions were perhaps one of our greatest untapped tools in teaching children with autism. Not surprisingly, one of Zachary’s favorite things to write or see written by someone else was “a squiggle” – something that involved a lot of and usually quick motion during the very act of writing.

Interestingly, an area that was often viewed as “difficult” for children with autism – “pretend” – had been no problem whatsoever for Zachary as he worked on an exercise where he needed to distinguish between “real” and “pretend”.

In this exercise, two pictures were given. One was “real” – the other “pretend”. Zachary had to put a circle around that picture showing something “real”. Examples included a train with a happy face on the engine verses a real train, a boy sleeping in a bed verses a pig sleeping in a

bed, an animal reading a book, etc. Zachary easily was able to complete all such exercises requiring him to distinguish between “real” or “pretend”. Clearly, he knew the difference between real and pretend and had no problem showing me that.

Interestingly, if examples of “real” verses “pretend” included one of each in the exercise, for example a boy sleeping in a bed verses a pig sleeping in a bed, then, Zachary had a much easier time with the exercise. If however, there was “no reference” provided to compare the two to each other, then, that was more difficult. For example, if Zachary was given three pictures and asked to circle a “yes” or “no” to indicate whether or not something could really happen, he went more with what he actually saw. Thus, if there was only a picture of a dog in a car for example, with nothing to compare that to, such as a person in a car, then, Zachary had a harder time with that. Past references to draw upon were always absolutely key to Zachary and if none was available, then, things were much more complicated for him and required more explanation in order for him to get the correct answer. Also very interesting was the fact that when “asked” if a dog could drive a car, Zachary could much more easily come up with the correct answer than if he was being asked to look at a picture to determine if that could be true.

Obviously, in a “picture” that showed a dog driving a car, certainly a child could just look at that picture and based on “seeing that” decide it could be true, but, yet, if asked – verbally – when no picture or visual of this was provided – then, Zachary could easily provide the correct answer.

Thus, again, as with everything, understanding the issue was really the key to addressing it. I knew Zachary lived via “reference” and clearly those exercises that provided “real” verses “pretend” references – one of each – were the easiest for him to deal with and exercises such as those, he breezed through easily. Again, very interestingly, was the fact that the understanding of language and auditory processing were co-located in the temporal lobe along with the ability to distinguish between truth and a lie. Was this why Zachary could provide the correct answer more based on a verbal question as opposed to one involving sight? I was certainly of the opinion that this was indeed very much the case. The only sight perception in the temporal lobe had to do with face/place/body part recognition. These things were not at play in the exercises Zachary was asked to complete. Sight (primarily in occipital lobe although visual attention was in the parietal lobe), as such, clearly took a back seat in “understanding language” (temporal lobe function) when it came to the ability to distinguish between truth and a lie (another temporal lobe function).

As such, perhaps the expression “seeing is believing” was more reflective of how easily one’s ability to distinguish between the truth and a lie could be manipulated due to the fact that these functions resided in separate parts of the brain! As I thought about this, surely, it was easier to mistake someone for another based on “visuals” (sight) than sound (voice). I could often “see someone” and think they were someone else. Never, however, had I mistaken another man’s voice for that of my husband – at least not yet. :o) Of course, mine was not the best vision – but I certainly always felt I had “very good ears”.

All of this, for Zachary, had tremendous implications for “watching tv”. If this indeed was the case and that “seeing is believing” because of the fact that one’s ability to distinguish between truth and a lie was more easily manipulated via visuals, then, that certainly could explain why

persons with mental illness had such a difficult time distinguishing between the “real” and “non-real” when watching television.

The ability to distinguish between truth and a lie was in the temporal lobe – while vision and visual processing was primarily in the occipital lobe. As such, for now, I simply told Zachary that “television” was “pretend”. Granted, there were some things that were “real” in the sense that they involved real people speaking about world events, however, most things on television were clearly “pretend” or “not true” and as such, “pretend” was indeed a much better label for Zachary when it came to helping him distinguish between “real” and “pretend” in matters relating to the television. As with so many issues that had proven difficult for Zachary, the issue here was in my opinion, once again, a matter of a “moving target” or “moving references” with things being “real” at times and “not real” at other times.

“Moving targets” or “moving references” were always much more difficult for Zachary to understand and as such, they required much more in terms of explanations, etc. I always made sure I spent a great deal of time on these issues because clearly, the result of “not understanding” these things, as I explained in my section on pronoun confusion and on matters of “imaginary” verses “real”, in both my second and third books as well, could in my opinion, result or at least contribute to either the loss of self and/or the loss of one’s sense of reality and as such, I felt it was critical I absolutely address these issues with Zachary. I encouraged all families to read both my second and third books for more on these very, very critical issues.

Like many, many other parents of children with autism, I had also very much noticed that Zachary could answer questions much more easily if given a “choice” of answers. If no “choice of answers” was provided, then, it almost appeared at times as though he did not understand what was being asked. Yet, this was not the case, since, just giving “choices” for answers clearly revealed he knew exactly what the answers were. Thus, it was ***not an issue of “understanding the text”***, but rather something else. Zachary had very much understood the text – of that, I had absolutely no doubt.

I very much felt, again, this had a lot more to do with the “this way or that way” aspect to Zachary’s life and the need for references. When given choices, by definition, things were “this way or that way or that other way”, but this was not the case with an open-ended question where no “answer choices” were provided. As such, obviously, providing “answer choices” or “multiple choice type answers” to pick from had made all the difference in Zachary’s ability or desire to answer. In my opinion, it was critical to include as many choices as possible to try to get away from that “all or nothing” rigidity and allow for “in between” situations. Obviously, one certainly would want to move from “choices” to open ended questions whereby no choices were provided.

As with everything it was really a matter of actually teaching Zachary ***how*** to answer a question in order to provide for him a “reference” of how to do that. This was still very new to me and as such an area I still myself was working on. Yet, given I very much believed these children lived “via reference”, I knew I had to “teach” Zachary ***the concepts*** behind “conversation” and how it worked and that required ***“teaching how to answer a question”*** and providing for him that ***understanding that conversation was nothing more than statements of fact, questions,***

*exclamations or a “response” to any of those, involving two or more people. I knew I had to give Zachary an understanding of “what” conversation was and “how it worked” in order to move him toward “more conversation”.*

As I had no doubt that Zachary now understood language, neither did I have any doubt that he would have been seen as “simply not understanding” if he had been in a school setting and evaluated by a person who clearly did not understand how he looked at and responded to his world.

I now knew small things made a huge difference in understanding Zachary. Questions, for example, had to be worded in a very specific way – they had to be “positive” questions as opposed to “negative”. For example, if Zachary were asked: “You don’t want to go to the park?”, and indeed, he did not want to go, he would answer: “Yes” – meaning, “that’s right - I don’t want to go” acknowledging that the question, as asked, was correct in providing “his answer”. A “normal” person would most likely have answered: “no” as opposed to “yes” in order to indicate a desire not to go to the park. “Negative” questions, I found, were rather confusing until I finally realized that Zachary’s answers to such questions were nothing more than an acknowledgement that “the statement within the question was correct”. If I then followed up with the “positive” version of the same question, indeed, I found this to be the case almost 100% of the time. For example, if I now asked: “Does Zachary want to go to the park?”, he would respond “no”, again indicating he did not want to go to the park.

I had noticed this was an issue for Zachary time and time again. It was as Zachary was crying one day that I had finally come to understand the issues with “*talking in negatives and positives*”. We were at home and Zachary had hurt himself slightly. He was crying and as I went to comfort him, I had said: “Oh, you’re not a happy boy...” and he had replied: “yes”. At first, I thought he was trying to tell me that he was happy, but, given the situation, I knew this could not be true and it was then that I realized that he was acknowledging my statement of “you’re not happy” to be correct. I then confirmed my suspicions by asking: “Are you a happy boy?” and “Is Zachary a happy boy?”, and, just as expected, this time the answer was “no” as opposed to “yes”.

“Talking in negatives” was simply much more difficult for Zachary – and when issues of “pronoun confusions” also crept in, it was easy to see how communication or responses given by children with autism could be interpreted to mean the exact opposite of what they should. It would certainly be easy to think that children with autism were “not understanding” in such situations when in fact, they understood perfectly well and it was again, the adults, who failed to simply understand the issue hidden within these responses. Obviously, the key to overcoming confusing conversation was simply to use “positive language” and to avoid “negatives” such as “do not”, “not”, etc. in asking questions. I also found that if I gave Zachary the answer and had him repeat it that this also helped. For example, I would have Zachary repeat: “No, I don’t want to go to the park” or “No, I’m not happy”.

In so many things, it was as though “the positives” were easier to deal with than “the negatives”, in everything from conversation to directions. I was certain this was somehow all tied together in terms of how information flowed in Zachary’s brain and that this touched many, many aspects

of his life. There simply had to be something about why “going forward” was better than “going backwards”, why some letters were written properly and others could be written backwards, why negative sentences “worked backwards” in how they were interpreted. I suspected all this was somehow interrelated, but I did not understand “the mechanics” of it in terms of information flow in the brain.

Zachary certainly had finally reached that point where conversation was there and each day I found myself more and more thankful as I considered Zachary’s progress. Looking back, I could not help but be amazed at how far he had come in spite of the fact that there were still hurdles ahead that had to be overcome. Finally understanding Zachary, however, made all hurdles seem so much easier to tackle.

There was no doubt that “socialization” in and of itself was difficult for children with autism. Likewise, actual schoolwork involving “social studies” or matters requiring “creativity” were much more difficult for Zachary than were things that involved “rules” – such as language, math or science. Zachary clearly was a “left brain dominant” child – of that, I had no doubt.

Materials that involved creativity, such as drawing activities where Zachary had to come up with “his own drawings” were much more difficult for him. If he was told exactly what to draw (i.e., draw a house or a tree), that was much easier although a “first attempt” at anything usually resulted in a “You draw it, mom... draw a...” response because Zachary always wanted to be shown “how” first. He always wanted that “reference” to draw on. If then asked to draw the same thing again, he usually hesitated a lot less. But, if he was given very broad instructions, such as “draw your family”, or “draw something you find at the circus”, or “draw something you like to do”, where specifics were not given, then, the exercise was practically impossible for him unless a great deal of help was provided.

If given a picture and asked to provide a “personal” example of something he liked, again, that was virtually impossible for Zachary to do on his own. For example, say he was given a picture of a little boy who liked to fish with the words “my favorite place is...” below the picture, Zachary could only “see the picture – the reference - before him” and so he gave the answer “fishing” even though he had never really gone fishing in *his* life. In other words, he could not see that he had to “look beyond the picture” or – the reference - to something “he” actually enjoyed doing. If asked to draw what he would like to be when he grew up, Zachary would revert to a “past reference” and draw – “a truck”. Clearly, he could not be “a truck” when he grew up, but, it was something he very much associated with. He did not even attempt to draw a “person” or “truck driver” – just “the truck” – that “reference” that he so often seemed to revert back to in life, or in moments of stress, as discussed in my previous books.

It was not an issue of Zachary being “unable to pretend” or imagine himself in a particular situation. I knew all too well that Zachary had the ability to pretend – once shown how – once provided “a reference” to draw upon when it came to “pretending”. With Zachary, I had all too clearly seen that any “lack of pretending” or “lack of imagination” was simply the result of not having a past reference to draw upon.



I knew there were many who thought that children with autism were unable to engage in “pretend play”. In my opinion, that simply was not true, and indeed, once provided a “reference” of “pretend play”, I believed there was a danger of the child perhaps integrating the pretend and the real so much that he literally could not tell the difference. This area of “pretending” was an issue of great concern for me as discussed in both my second and third books – a topic I strongly encouraged all parents to read about.

There certainly seemed to be many other “traps” to watch for in teaching materials – materials that too often failed to teach – concepts – and the teaching situation overall. My intent here was simply to help parents be much more conscious of the issues in communication as they related specifically to the teaching situation. If there was one “trap” to watch for it certainly had to be materials that failed to teach – the basics – the concepts – and provided confusing information!

Materials I had done to help Zachary in learning time, money, basic addition, etc., were provided on my website for all parents of children with autism under a link entitled ***Teaching Tools***. I also provided information on teaching colors based on what I had now come to understand in Zachary although I had not used this particular method for teaching Zachary colors. He already knew them by the time I had figured out what “the problem” was and why colors had been so difficult for him to learn.

It had taken me close to three weeks to make my “time” materials. Zachary now understood time and could read it fine. I knew children who were eight and nine years old who did not understand how to tell time as well as Zachary did. A woman who had taught school for twenty years had once told me that she had fourth graders who had problems telling time. Well, given children today were not being taught concepts but rather were expected it seemed to figure things out based primarily on examples – let me just say that my response to her was “I’m not surprised!”. Granted, my “time” materials were much more involved and looked much more complicated than what one would normally find in schools, however, there was no doubt that my “time” materials taught the concepts – and that, I was certain, was why Zachary had so quickly grasped how to tell time. He understood how it “fit together”!

Obviously, I could go on forever on this topic as clearly, examples of poor materials were quite plentiful, but I certainly hoped these examples had provided enough of an understanding of “challenges” faced by children with autism when it came to teaching these children. Indeed, as I considered all of this, I now understood why so many children overall – including “normal” children – had so many issues with schoolwork.

In my opinion, it was not teachers that appeared to need to be most put to the test – it was the materials themselves! Granted, there had to be a certain level of competence in teaching, however, there certainly had to be an even much greater level of competence necessary for those who came up with these materials in the first place!

Failing schools? Failing teachers? Failing children? Failing materials? In my opinion, the answer to the first three could be found in the fourth!

Of course, there was no denying that in the midst of budget issues, children with “special needs” had become rather “valuable commodities” to school systems.

My nephew, Andrew, had been diagnosed with PDD (Pervasive Developmental Disorder). Quite frankly, as I learned more and more about autism, the one thing I came to understand clearly was that the “label” mattered very little – autism was autism. Labels simply provided ways for society to ease the pain of a parent in my opinion. After all, it was much easier to tell a parent that his child had “attention deficit” than to tell a parent that child had autism. Likewise, it was much easier to tell a parent that a child had “autism” than to tell a parent that child had “schizophrenia”. Yet, clearly, all these disorders were but shades of the same thing varying only slightly in “matters of degree”. A label of “autism” certainly did not change the fact that my child shared well over one hundred characteristics with persons having “schizophrenia”, nor did it change the fact that my child shared well over one hundred characteristics with a person having “Alzheimer’s” [more on this in book three].

Truly, in my eyes, “the label” was irrelevant. A label of “this” or “that” did not change who my child was. In my opinion, all a “label” provided was a way for society to justify itself – to justify “research or education” fund allotments – and not much else. Indeed, as I looked at “how labels were used”, there could be no denying that labels were used, primarily, for the allocation of funds – and quite frankly, that “allocation of funds” most often did not provide funds directly to that child who had been “tagged” with the label and hence – marked for life – or “defined by his label”.

As I considered the issue of “allocation of funds” based on labels, there could simply be no denying that the bulk of funds “tied to labels” went to “research” or “cookie cutter social programs” that clearly were not tailored to the child as they should be. Unless funds were “velcroed” to a specific child – tagged to that particular child – just as was his label – the label, quite frankly served as nothing more than a “budget item” for society to determine its budgets and capital expenses when it came to “expanding programs”. Unfortunately, too often, it appeared those “expanded programs” resulted only in getting “more stuff” for the school in general as opposed to actually getting “more help” for the individual child – and therein was the problem with “labels”.

I had discussed this issue at length in my second book, *Breaking The Code To Remove The Shackles Of Autism: When The Parts Are Not Understood And The Whole Is Lost!* When my nephew Andrew had been in the school system, for a time, funds for his education – the education of a child with very special needs – had at one time been “velcroed” to Andrew – specifically. In other words, the funds had to be used only for Andrew’s education. Andrew’s mother had noticed that over time, Andrew’s aid was being used to help more and more with “normal children” in the classroom. Although Andrew had been in an “integrated class”, he clearly was still very, very far behind in many subjects. The school had slowly started to use “Andrew’s aid” as a “general aid” to help with all children. When Andrew’s mother raised the issue that funds for Andrew were supposed to provide for an aid to help Andrew specifically in school, the school was quick to “redefine” how funds for special needs children were to be used. No longer would the funds be “velcroed” to the child – they would simply be “velcroed” to the program – in general. As such, Andrew basically lost his aid and his mother made the decision

to school him at home. Thus, labels, quite frankly, were nothing more than ways of getting “extra funds” for schools, and yet, it certainly appeared to be the case, for too many children with special needs, that those “extra funds” in no way had to be “velcroed” to the child with the special needs and herein was the perfect example of why a label was nothing more than a way to get “more funds” - be that in research or education – and provided very little in terms of actually meeting the needs of the child himself!

There was simply no denying that children with “special needs” provided “greatly needed extra funds” for ever increasingly financially strapped schools and research programs and it was time parents awoke to that fact and realized what was really going on when it came to “labels” and the special needs child! Schools such as that my nephew had attended had been quick to request “additional funds” for “special needs children” and yet, they had no program in place to deal specifically with children such as my nephew – no special curriculum, no special activities – nothing! In my opinion, from what I had seen with my own nephew and read on so many parents discussion boards, there could be no denying that schools certainly wanted the “extra funds” but that they did not necessarily want to deal with the “special needs” of the child for whom those funds had “supposedly” been received. Granted, this was not the case for all programs and/or schools, but in my opinion, it appeared there was just “a little too much of this going on” – and that was very much to the detriment of the child to whom we had affixed “a label” in the first place!

Schools were supposed to be there to help these children and their families and yet, more and more, parents were finding themselves battling these institutions to get the help they needed for their children – help that had “supposedly” been “funded” for these special needs children. When it came to the issue of schools and children with special needs perhaps it was time for a major overhaul.

## One Piece At A Time... One Day At A Time...

As I looked back over the last few years, there was no denying that our journey with autism had been a long and painful one, but, likewise, there was no denying that there had been many, many joys also and a much greater appreciation for even the simplest of treasures in life. A first glance, a first word, a first kiss... each smile, each step, no matter how small, had been so very cherished.

There were still so many pieces to my puzzle I needed to understand in order to help Zachary, but, I knew that if I persisted, each piece would eventually fall into place. My understanding of Zachary had increased so much in the last three years, and, as a result of that greater understanding, there was now much more joy and much less stress in my family's life. Yes, we still had challenges to face, and yes, there were still many, many things I felt I still had to understand, but at least now, I understood enough of how my son's brain worked to help him considerably in teaching him how his world fit together. Obstacles were now easier to identify and overcome. Each day, I continued to look for clues, in Zachary's words and gestures. I knew they were there... and it was just a matter of time before yet another piece fell into place.

There were some things that were much less of a concern for me now – like spinning – but that Zachary still did – although to a much lesser degree. Even though less of a concern, I still found myself wondering – why – on so many issues as I lay on my bed as I so often did, thinking about this huge puzzle I had once only known as a word – autism.

The autism puzzle was one that had so captivated my life and that of my family. This disorder I had once so painfully prayed God would remove from my life, I now, with each passing day found more and more fascinating a puzzle to unravel. As such, even though things like “spinning” were less of a concern, I still pondered these issues in an attempt to better understand why it was these children behaved the way they did.

Spinning, with its motion and its integration of the parts into the whole, was an activity so many children with autism engaged in. As with so many issues, even though they were slowly slipping into the past, my desire to understand them was still very much in the present because I knew that understanding could so help the future of so many. And thus, even though some things I knew could eventually slip completely into the past, and indeed I had once prayed to have them become “just part of the past”, I now consciously chose to keep in the present. I wanted to understand autism and its many facets – and that included things like spinning – things I once would have been perfectly happy to leave completely behind if the behavior or issue ever completely disappeared in my son.

I knew all these things were somehow interrelated and as such, even though an activity in and of itself may be slowly drifting away, I resolved to try to remember all the pieces, past and present, because I very much knew that even those pieces slowly slipping into the past still held keys that, potentially, could unlock so much. I no longer looked at “just spinning” but looked for ways in which each piece fit into the whole, for ways in which all these things somehow fit together –

because I knew – somehow – they did. All these parts to the puzzle fit together and were interrelated. There were no “isolated factors” that stood by themselves... all of it... had to somehow fit and that now made me look more closely for how these things could all be interrelated. For example, I knew spinning and colors both played a role in all this – but how were they related? Could these two aspects to autism somehow fit together?

As I considered “spinning and colors” for example, I remembered something I was embarrassed to say I had forgotten for so long. I knew light could be put through a prism and separated into the colors of the color spectrum – red, orange, yellow, blue, green, indigo, violet. What I had forgotten, however, was that if you were to take a circle and divide that circle into thirds and have one third red, one third blue, one third green and then proceeded to “spin” that circle, you would find that the colors “disappeared”. As that colored circle spun, the red, green and blue were no longer visible, but rather, what your eye perceived was more of a white or light gray. Could this somehow play into Zachary’s fascination with spinning and colors? I did not know, but it certainly could be another possibility.

Of course, there were certainly things Zachary had spun that had only one color, and often, that color could be a rather “boring” color. And then there had also been “degrees” of spinning, at times involving very fast motion and at other times involving rather slow motion. To me, that indicated the fascination with spinning was very much tied to the motion itself. And then, there was also the issue of “the parts to the whole” discussed in my second book when I realized Zachary was trying to remove the parts of a wheel, and that when frustrated as he could not do this, he started to spin the wheel. There now seemed to be so many aspects to what had once seemed to be a simple activity – spinning.

Yet, although spinning and other pieces of my puzzle were not completely understood, at least what I had now come to understand in Zachary made it so that at least my world did not feel as though it were spinning out of control. I now understood enough in Zachary to keep things more in control and that allowed me to help Zachary more than I ever imagined I could. Granted, there were many things left to learn, but, at least now, I had enough to go on to help my son tremendously in breaking the code not only to language and communication – but, to life.

With each passing day, Zachary’s communication skills were improving. I had noticed, not very long ago, however, that Zachary was writing some of his letters backwards – a condition known as dyslexia. He really had not done this in the past – a few times – yes, but when I saw two errors in one word, needless to say, I was concerned. I had recently hurt my back and had not spent as much time doing homework with Zachary in the last month, and I wondered if that had contributed to this situation since he had been “away from homework” for a while. However, I also knew that many, many children with autism also had dyslexia and as such, this certainly was not something to “brush off”.

I wondered again how all this was related. Recently, as Zachary was getting ready for bed and he lay on his back on my bed as I changed his clothes, I noticed him looking at my ceiling fan. As the fan turned slowly, I asked Zachary why he liked my ceiling fan. I had asked him this question a few other times in the past as I tried so hard to understand the love of spinning in children with autism. There had only been one other time that Zachary had given me an answer

to that question. In the past, he had answered that he liked “the wind”. On this particular night, when I asked him the same question, he answered: “forward”.

I knew Zachary had issues with direction changes. In the past, I had painfully seen that in our walks, in the fact that he almost drowned at the age of three when he had snuck out of camp at 10:00 pm or so and was found at the end of the dock, with a watered down diaper, holding on to the very end of the dock with just a finger or two, facing away from shore. I had seen this issue with “direction” in so many aspects of Zachary’s life. In the past, it certainly had also been something I suspected was at play with spinning also. I knew it had something to do with why Zachary used to hate seeing the VCR run backwards, it had something to do with why he screamed whenever we would make a change in directions in the car or whenever we put the car in reverse. And now, I was seeing an issue with the direction of things in Zachary’s writing of letters and numbers. Again, I knew all these things had to somehow be related. The only thing all these issues had in common was “direction”.

Just labeling “going backwards” when we put the car or videos in reverse had greatly helped Zachary. I knew labeling the proper direction for letters and numbers in writing would help also, but, now, I was truly beginning to suspect that one of the many critical underlying issues in autism had to do with processing of matters involving “direction” and “direction changes”. Letters and numbers, after all, involved motions that had many “direction changes”. This was all very new to me and now, I found myself with yet another issue to tackle. The question was – was it really a new issue - or just another shade of the same thing? I just could not help but think all this, once again, was somehow related. If that was indeed the case, then teaching letter and number formations, in my opinion, had to involved the use of arrows to show the proper direction involved for letters and numbers to be formed.

In the past, as I worked on “writing issues” with Zachary, I had noticed that providing references for each letter had always made Zachary much more enthusiastic when it came to writing. I had made practice sheets for writing letters and numbers and pulled those out for Zachary on a regular basis.

As we practiced letter and number writing, I came up with “tricks” to help Zachary remember how to write his letters. For example, an “A” was said to “look kind of a triangle with a bridge in the middle”. Although I had used some “left” and “right” in these reminders for letter writing, I would now include more of that given this recent issue with dyslexia, as I knew that additional distinction or qualifier would help him with this issue going forward. Examples of what I used for each letter and number were provided in the tables below. The short phrase(s) next to each letter or number was something I would say as Zachary wrote in order to provide cues for him in the formation of each letter. Again, I added a lot more “left” and “right” here than what I had used in the past only because I knew this would help Zachary in the future given he had a very, very good understanding of the concept of “left” and “right” as well as “up” and “down”, “top” and “bottom”.

<b>CAPITAL LETTERS</b>	
A	Looks kind of like a triangle with a bridge in the middle
B	Looks like a big stick on the left with two bellies on the right
C	Looks like a circle with a mouth on the right
D	Looks like a stick with one big belly on the right
E	Looks like a big stick with small sticks on the top, in the middle and on the bottom right
F	Looks like a big stick with small sticks on the top and in the middle on the right
G	Looks like a circle with a tongue on the right
H	Looks like two big sticks with a bridge
I	Looks like a big stick with a small stick on top and on the bottom
J	Looks like a big stick with a hook on the left and a small stick on top
K	Looks like a big stick with an “in and out” on the right
L	Looks like a big stick with a small stick on the bottom right
M	Looks like two big sticks with a “V” in the middle
N	Looks like two big sticks with a broken bridge falling down
O	Looks like a big fat circle
P	Looks like a big stick with half a belly on the top right
Q	Looks like a big circle with a tail
R	Looks like a big stick with a half belly and a tail on the right
S	Looks like a big snake going left then right then left
T	Looks like a big stick with a little stick on top
U	Looks like a big stick with a hook to the right on the bottom touching another big stick that goes just a little bit past the hook
V	Looks kind of like a big open upside down triangle
W	Looks kind of like two big open upside down triangles stuck together
X	Looks like two big lines crossing each other
Y	Looks kind of like a small “v” on top of a stick
Z	Looks like a small stick going right, then a big stick down to the left, then a small stick going right

Obviously, there were many, many variations to this. It was simply “the concept” I had wanted to present here.

I then did the same type of thing for small letters.

	<b>small letters</b>
a	Looks kind of like a small circle with a small stick on the right
b	Looks like a big stick on the left with a small belly on the bottom right
c	Looks like a small circle with a mouth on the right
d	Looks like a small circle with a big stick on the right
e	Looks like a small stick going to the right then making a small “c” or a small circle with a mouth on the right
f	Looks like a small hook on the top right coming down to make a big stick with a small stick in the middle
g	Looks like a small circle with a stick on the right going down and making a hook on the left at the bottom
h	Looks like a big stick with a small hill on the right
i	Looks like a small stick with a dot on top
j	Looks like a stick going down with a hook on the left and a small dot on top
k	Looks like a big stick with a small “in and out” on the bottom right
l	Looks like a big stick
m	Looks like a small stick with two bumps on the right
n	Looks like a small stick with only one bump on the right
o	Looks like a small circle
p	Looks like a stick going down with a small circle on the top right
q	Looks like a small circle on the left with a stick going down and making a hook on the right
r	Looks like a small stick with a little arc on the top right
s	Looks like a small snake going left then right then left
t	Looks like a big stick with a little stick in the middle
u	Looks like a little stick with a hook to the right on the bottom touching another little stick that goes just a little bit past the hook
v	Looks kind of like a small open upside down triangle
w	Looks kind of like two small open upside down triangles stuck together
x	Looks like two small lines crossing each other
y	Looks kind of like a small “v” on top of a small stick
z	Looks like a small stick going right, then a small stick down to the left, then a small stick going right

Again, parents could easily come up with their own “variations” to this. I had simply wanted to provide the “concept” here.



For numbers, I did something very similar to this again.

<b>Numbers</b>	
0	Looks like a big thin circle
1	Looks like a big stick
2	Looks like a half heart with a small stick on the bottom right
3	Looks like a small half circle on top of another small half circle both open on the left
4	Looks like a small stick down, then a small stick over to the right and a big stick down on the right
5	Looks like a small stick going left on top, then a small stick down with a belly on the right
6	Looks like a stick down curving to make a small circle on the bottom right
7	Looks like a small stick going right on top then a big stick down on the right
8	Looks like a small circle on top of a circle or a big "S" that loops back up
9	Looks like a small circle on the top left with a big stick on the right

Such were example of hints I gave Zachary as he learned to form letters. Obviously, as Zachary's interests expanded, these examples could change slightly to provide more vivid reminders. For example, lately, Zachary had discovered "mini-put". Therefore, a small "b" could now look like a golf club. There were certainly countless reminders parents could use to help their children with letter and number formations. In my opinion, such associations had been quite valuable for Zachary as he learned how to write. Again, the "left" and "right" I added more of in the above examples as I knew this extra qualifier would now become quite important in addressing matters of dyslexia recently surfacing in Zachary and as such, I provided examples here so that any parent "starting fresh" who wanted to use some of the tricks I used with Zachary some idea as to how to possibly address this issue from the start in order to help with any matters of dyslexia that may surface in the future.

There was certainly no denying that autism had a new challenge at every bend. Yet, neither was there any denying that Zachary was making progress each day. Yes, there were definitely things that seemed like "steps back", such as this recent issue with dyslexia, but there were also many, many steps forward. As a parent, all I could do was do my best to help Zachary and take each challenge one day at a time. Again, knowing the issues and what could possibly be ahead, in my opinion, certainly helped in planning "strategies" in order to address these issues as early as possible. I knew that many parents on discussion boards mentioned their children with autism had issues of dyslexia. I had made the mistake of thinking in the past this was a "non-issue" for Zachary given he previously had made his letters properly. That had been another error on my part. Obviously, if this was an issue for so many children with autism, perhaps all parents of children with autism should err on the side of caution and assume this was something that could very likely occur in their children and hence, address the issue right from the start in the teaching of letter and number formation. Again, for me, this would be another one of those - "if only I had known". At least I knew what I had to do to help Zachary with this issue now. We would just have to go from there...

In spite of the new challenges, there certainly was no denying that Zachary was making progress. He was now more expressive than ever. Recently, when his sister Anika had taken his beach

ball and was playing with it in the house, Fred and I could not help but giggle as we heard Zachary saying: “I’m jealous” as he asked Anika for his ball back. Of course, when an expression of emotion did not work well in retrieving his desired toy, “commands”, a form of communication Zachary knew to work rather well, such as “give me that ball”, were just around the bend. Zachary also loved music and on August 11<sup>th</sup>, 2003, the day before his 6<sup>th</sup> birthday, Zachary came to see me as I sat talking to his father in our home office and with a big smile on his face, he said: “Dance with me, mom”.

When we had first discovered Zachary had autism, I used to take him in my arms and dance with him to the music of Andrea Bocelli. This man was a blind tenor whose music I enjoyed tremendously. This particular CD was called Romanza. Neither one of us understood the words since they were in Italian. My knowledge of French allowed me to pick out a word here and there, but that was about it. Yet, Zachary, too, had always found this music so soothing. Now and then, as music played, I had always taken Zachary and danced with him and this had been our favorite music to dance to when he had been little. It was only recently that I had actually labeled for him what we were doing as “dancing” as I showed him how to move his feet and twirled him around. Granted, he was still very much an awkward dancer, but then again, so was I.

On this particular day, it had been pop music that played in our home when Zachary – for the first time – had asked me to dance. Anika had been in the kitchen, but somehow, she always kept an ear open for her brother and as such, we had all had the joy of hearing Zachary’s words as he asked me to dance. From the kitchen I heard Anika shout: “Did he say what I think he said? Did Zachary just ask you to dance?” I answered, “yes”, as I took Zachary’s hand and went with him to my bedroom where the music had been playing as I said, “let’s dance together”. In no time at all, Anika had joined us and the three of us joined in a dance as we all held hands. As with so many other precious moments, this had been something he had never done again – but that mattered not for now. The fact was – he had done it – on his own – at least once and hence, I knew that “reference” had been made and he had been able to properly apply it. Yes, autism had brought some very difficult moments to our family and I had no doubt there certainly would be more, but, there were now more and more of those golden moments too – moments like this that you come to treasure forever in your heart.

Indeed, where there once had, it seemed, only been tears – now, there could be joy again and a giggle here and there as Zachary, with each passing day, exposed the pearl that had for too long been hidden within. There was no doubt that he was now very much part of this world and that he enjoyed it tremendously. As his sixth birthday approached, and the state fair opened on the day of his birthday, we did the “countdown” to “scary rides”. I had taken Zachary to the fair last year and he had absolutely loved it. Atari had a software package called Rollercoaster Tycoon – it was among both Zachary’s and Andrew’s favorites. Although we had originally purchased that program for Anika, in no time at all, Zachary had also become an expert rollercoaster builder and there had been many a time when Anika looked over his shoulder at his latest creation as she asked Zachary: “How did you do that”? Zachary certainly had a talent for building roller coasters that looped and twisted in a seemingly endless manner. The ups and downs of roller coasters, I was happy to see on the computer as opposed to having those roller coasters be part of my daily life. I knew there would certainly be more roller coasters ahead for our family as we

continued our journey through life with autism, but at least for now, the ups and downs had settled a little and the hills no longer seemed as insurmountable. Staying focused and on track had been absolutely key for our family as we all worked at “saving Zachary”.

One day at a time... one hill at a time... one bend at a time. Certainly, the ride had been very rough at times, and it may be again in the future, but, the ultimate key to the autism roller coaster of life, in my opinion, was to hang on tight to – our child and each other – and – to never lose hope...

## Trying To Get Those Kids Talking...

There was no doubt in my mind that different children were different types of learners. Although there were many, many similarities in how children with autism appeared to view their world, there were also differences I knew I could not ignore. I was an expert on my son – but only my son. Likewise, every other parent of a child with autism knew his or her child best.

As I looked at how Zachary's speech had progressed, there had been no question in my mind that he very much was an auditory learner. He had learned his phonics almost overnight based on sounds only – no visuals. Yet, when I discussed “learning styles” with my sister-in-law, Christine, who had a twelve-year-old boy, Andrew, diagnosed as PDD (pervasive developmental disorder – on the “autism spectrum”), she had mentioned she felt Andrew was more of a visual learner than auditory. For a few moments, I wondered why that could be. Was it because she had seen how visuals could so easily “trick Andrew”, as had the “greater than” exercise for Zachary – or was it “something else”? Could Andrew be more of a “visual learner”?

There was no doubt that it could absolutely be the case – children varied greatly in “learning styles”. Yet, so many children with autism were still “non-verbal” and the methods that appeared to be used the most with children with autism seemed to emphasize things like picture type communication, etc. If indeed “visual learning” was better for these children – why were so many – still “non-verbal”? Why were so many of these children – still in their own world? As I thought of these many children and their parents, my heart could not help but feel tremendous sorrow. Having the joy of finally hearing Zachary's voice – and hearing it more each day – was so very, very precious to me and now, I hoped that more than ever for other children with autism and their parents.

As I thought more about Andrew and Zachary, I soon realized that science had indeed shown that the “use it or lose it” theory applied not only to muscles in the human body but to the brain as well. Thus, those parts of the brain “most used” would be in “better working order”. That certainly made sense. Ever since both Anika and Zachary had been very young, I had always made it a point to play music for them at night as they went to sleep. I usually played classical music, nature sounds (i.e., birds singing), harp or cello music. Certainly, this would have helped Zachary process “more information” in that part of his brain. Interestingly, the processing of music was co-located with the understanding of language in the temporal lobe. I could not help but wonder if doing this had allowed Zachary to “rebuild” connections that may have once been severed, and hence, helped him to rely more on sounds. I very much suspected that indeed this could be the case.

It was only after months of working with Zachary on matters of safety that he was finally started to “use his eyes” to “see” cars. As stated in my second and third books, safety had been a huge obstacle for Zachary and it was only very recently that I finally saw progress in this area of “seeing danger”.

The one thing that I knew both Zachary and Andrew had in common was their love of similar activities to keep themselves entertained. They both loved cars, trucks, trains, puzzles, and, of course, K'NEX – that toy that had all those wonderful little pieces and allowed a child to create

untold variations of their masterful geometric wonders. Zachary and Andrew also loved the same computer games – especially games like Rollercoaster Tycoon. If left alone, they could spend hours playing that game. This was a software program whereby a child could build his own rollercoaster(s) and theme park and maintain or grow it much as you would a “real theme park”. Although I had come to understand that a tremendous amount of the brain was active while a child was on the computer, there was no denying that “Rollercoaster Tycoon” provided many, many “visuals” and certainly must be a program that very much activated the visual cortex.

Andrew had been playing with K’NEX and games like Rollercoaster Tycoon for quite some time now. I wondered how games such as these had contributed to the development of his brain in the visual cortex and if such activities in this child could explain why his mother considered him more a visual learner whereas I had, for the most part, considered Zachary an auditory learner. Interestingly, sight in infants was said to take up to eight months or so to reach adult-like vision and clarity. I knew that diabetes could very much rob a person of their sight and I also knew that Zachary had been born low on glucose – a clear sign of a problem with insulin. Was his sight worse than Andrew’s? I had no way of knowing, but I certainly wondered, especially given I now very much suspected diabetes and autism were also very much inter-related (see book three, *Breaking The Code: Putting Pieces In Place!* for more on this issue). Zachary’s vision, in terms of being able to “see words”, read, etc., seemed ok.

On so many occasions, Christine and I had talked, trying to understand what we saw in our children. We had shared difficult times, but many a laugh too. So many times, those laughs had started with a conversation regarding the “expanding” of a new concept by our children to another area of life.

As I completed this book, for example, I had started to teach Zachary about “silent letters” in speech. As I showed him words like “knee, knock, whale”, etc. and said: “silent letters are *letters you see but don’t hear*”, I knew he understood almost right away. He could easily tell me “the silent letter” in a word. Later that day, Anika had been watching a video that Zachary did not particularly care for and as such, he was pestering his sister to put on something different. As I tried to get Zachary to let Anika have her time of relaxation, and, from the kitchen sink said to Zachary: “Zachary can watch a video after Anika finishes watching her video”, I could not help but chuckle when I heard Zachary’s reply: “Nnnnno... that’s a silent sentence... I don’t hear it... that’s a silent video... I don’t hear it.”

Obviously, Zachary had not liked what he heard, although, in a funny way, it was music to my ears. This reply on Zachary’s part indicated proper pronoun usage, something I had worked on with him, and the understanding of a concept taught earlier that day – a concept that was now clearly being “generalized” to other aspects of life...another plus. Certainly, however, I did not want Zachary to think he could simply say things were “silent” when the utterances heard were not those he wanted to hear. That would have been a very bad message to send on my part. As such, I had to correct that “generalization” in order to prevent problems down the road.

I made sure I told Zachary that he could still “hear the video” – that it was “not silent”. I then said to him: “Tell Anika that video is **not interesting** and ask her to put another one on”. And

so, Zachary said: “Anika, that video is not interesting... change the video”. Luckily for me, Anika had always been very, very patient with her brother and she knew that when he learned something new, it was to her advantage to help “reinforce it” also in order to help move Zachary along in understanding his world and how to live and communicate in that world. As such, she gladly put a new video on for her brother. Not surprisingly, Anika had become quite a little reader and so, picking up her latest book was always an alternative for her and one she enjoyed. I was always complimented on Anika’s love of learning. Anika had truly been a huge blessing in our lives and there was simply no denying that siblings could be a tremendous help in teaching their brother(s) or sister(s) with autism. Zachary, too, had been very, very blessed to have Anika in his life.

Anika, herself, had truly grown because of our journey with autism. She had patience and understanding beyond her years. She knew how to control her brother’s behavior when he was upset, she knew how to make him happy again, she knew what he wanted when, at times, my husband and I did not, she knew how to get Zachary to play and interact, she knew how to react and interact with him in so, so many ways. At age eleven, I could already see how she also used so many of the tricks I used to get Zachary to do what she wanted. She knew that so often these children preferred questions that had “this answer” or “that one”... and as such, she had become a master in wording things in a way she knew she would get “what she wanted” in Zachary’s answer.

For example, if Zachary was “whining” in any way because he wanted to play the computer game she was playing, Anika knew to give him a choice by saying: “Zachary... stop whining **or** go to bed?... which one?” Or, she could say: “Stop whining and take turns **or** turn the computer off?” Of course, Zachary would pick, “stop whining” and that was usually enough to make him stop the “whining” behavior. Long ago, we had all come to understand so many of “the tricks” involved in keeping Zachary under control and helping him to understand his world and indeed – himself.

The night prior to my finishing this book, for the first time ever, as we prepared Zachary for the night and brushed his teeth, he said: “Put Zachary up there... Put Zachary in the mirror”. He had wanted us to lift him onto the bathroom vanity in order that he could see himself in the mirror. As I helped him up onto the vanity and held him so that he would not fall, again, there before me was another opportunity for a lesson.

As Zachary looked at himself, I said: “Who is that in the mirror?” Zachary answered: “It’s Zachary”. “Yes, it’s Zachary”, I said, and Zachary equals... I was looking for the answer “it’s me”. “Zachary equals me” he said as he smiled at himself in the mirror. Note that I did not say: “it’s you” because I did not want to label Zachary as “you”. Zachary needed to understand that “Zachary looking at himself” equals “this is me” - not “this is you”.

Coming to understand my son had been a very long journey, but, it had been a very rewarding journey also. Each day, Zachary thrived and learned and came to understand more and more about the world around him and about himself. Granted, there were differences in how children learned. Yet, children with autism were “similar enough” in so many ways, that I wanted to share how I would go about teaching language were I “just starting” my journey with “autism”.

It was in looking at “the similarities” that I collated these materials and tried to make them so that children could learn from them no matter what their area of strength. The materials provided could be used in a way that emphasized auditory processing, visuals, motion (i.e., by using a chalkboard to write on, etc.), color, etc. and as such, I felt there could be “something” here that could be “that first domino” to finally help open up the world of so many children with autism.

In the remainder of this book, I wanted to provide for parents the “what I would have done if only I had known what I knew now” and were given the opportunity to go back in time in addressing matters of language and communication in children with autism. I was no therapist or doctor – just a mom with a few thoughts to share with other parents. There could be no guarantees that any of this would work for a particular child. Yet, based on everything I had seen in Zachary’s language development, I knew that there were certainly some insights I could provide as a mother of a child with autism that may help another family in trying to get those kids who were not communicating to start talking.

There was no doubt that cerebellum damage had been well documented in children with autism. Although many still thought of the cerebellum as a part of the brain involved pretty well only in the coordination of motion, science was now indicating that this part of the brain appeared to also be involved in the coordination of other things – like emotions, higher thoughts and language. If there was one area of hope for these children, in my opinion, it certainly had to do with the fact that the cerebellum was now known to continue to develop for over twenty years. The very part of the brain known to be so impacted in autism continued to develop for over two decades and was now known to be impacted more by environment than genetics according to the work of Dr. Jay Geidd, as described in my third book, *Breaking The Code: Putting Pieces In Place!*

As such, in my heart, I felt there had to be hope for so many of these children who were considered “non-verbal”. The simple fact that the brain continued to grow and change over time, in my opinion, meant there was hope of new connections being formed in the area of language where connections may have been severed in the past. If the cerebellum was most impacted by environmental factors and had to do with matters of “learned skills”, well, there was no denying that “language” was a learned skill.

From what I had seen in Zachary, I knew that children with autism could “know things” but not necessarily be able to communicate them. I certainly had seen this in Zachary, and if this had been true for him, there certainly was a possibility that it could be true for others as well. It had taken me over three years to come to a point where I finally felt I understood enough about the way in which Zachary’s brain worked to actually have an idea as to how to teach him the things he needed to understand. I knew each day, more and more parents were given the diagnosis of “autism” and felt that horrible inner death I had felt over three years ago. It certainly could be easy for a parent to slip into depression and despair upon receiving this diagnosis for their child. Yet, now, having gone through three years of autism, I knew there was a great deal of hope for these children and the most important thing for parents to do was to never lose sight of that. There were now more families than ever dealing with this disorder and there was nothing like the love of a parent to help a child escape the shackles of autism.

From the very start of our journey, I had realized there was no room for despair. To help in “saving Zachary”, I had to hit the ground running and I knew that was true for all parents who received this diagnosis for their child. It was because of this that I had wanted to share our story – in the hopes that it could help other families – other children – whose lives could all too easily be stolen by this disorder. In my opinion, to get those children back – to stop them from slipping into their own world – you had to – somehow – reach them and be able to communicate with them – if even in only the smallest way at first. It had been Zachary’s love of butterfly kisses – something so small, yet so precious – that had convinced me I had not yet lost him. From very early on, my hopes had been in those butterfly kisses – kisses I just could not bring myself to let simply fly away forever.

And so, as I had refused to give up, so too was it my hope for all parents of children with autism and hence, my need to share our story. As I looked back and thought, “if I had to do it all again” knowing what I knew now about how Zachary developed, and thought “could my experience with autism be of value for another parent”, I knew there were definitely some things I would have done or tried early on if only I had known what I knew now... and it was those things I wanted to share as they related specifically to language development.

The one thing I came to understand in Zachary was the importance of categorizing his world. For Zachary to understand his world he had to live in a “world of order” – and that meant he had to be able to categorize everything. That meant everything down to the most minute detail and in language. In the spoken language – that meant the ability to categorize sounds. As such, personally, **I felt it was very important to allow these children to “focus on the mouth” as opposed to trying to force a focus on the eyes.**

Again, when I considered the functions co-located in the temporal lobe, along with the “understanding of language”, functions such as categorization, memory functions, auditory processing (i.e., categorization of sounds), face recognition, etc. and the fact that boys, especially, focused on “parts to the whole”, in my view, it made perfect sense that these children would attempt to focus on the mouth in attempting to “break the code” to verbal language. As such, I would also “draw” on as many functions co-located in the temporal lobe as possible in order to help these children better understand their world – given I absolutely believed that co-located functions were much more inter-related than we may have ever imagined.

Note that “production of language” was in the frontal lobe along with motor functions, control of emotions and word associations. Yet, in order **to produce “coherent language”, I had to be able to first “understand it”... and as such, “understanding”, I believed, had to come “before production” – or before – “actual coherent speech” could occur** – and everything I had seen in Zachary indicated to me that “breaking the code” to the “understanding of language” necessitated **“a focus on the mouth”** – not on the eyes! If trying to “produce language” in a non-verbal child – why in the world would you focus on “non-verbal communication” via – the eyes – anyway. Verbal communication involved – the mouth – not the eyes!

In the written language – that meant there absolutely had to be an understanding of the alphabet. Granted, there was no doubt that physical damage to structures involved in language could be involved. However, I also very much believed that for these children to understand language,



each building block to language had to be categorized and that meant even the alphabet had to somehow be categorized. To just say the alphabet or to simply say a specific letter, in my opinion, did very little for these children because that provided a sound, but basically nothing else. Certainly, there was the “visual” provided in a written letter, however, if my theory was correct and these children had little or no communication among the various parts of the brain, then visual functions located in the occipital lobe would be of very little use in understanding the spoken word or sound of a letter. As such, I felt something co-located with “auditory processing” functions – some other function located in that part of the brain involved in auditory processing – the temporal lobe – had to be more useful. Of course, to me, the obvious thing was the function of categorization.

To categorize the alphabet, in my opinion, involved not only saying the letter, but providing also an association for that “sound” for future reference. For example, if I had to teach Zachary the alphabet all over again, I would use phonics as discussed earlier in this text. I would go through each letter, saying “a says a, as in apple, sometimes a as in cake”.

As stated in my second book, when Zachary first came to understand letters, he literally went through the entire alphabet before he went to bed, saying to himself, for example, “a is for apple, b is for bed, c is for car...” – all the way through the alphabet – and often, starting over with a new word for each letter. That had absolutely amazed me – it was as though he had been “ordering” his world before bed – but now, I also knew this exercise also very much had built “letter-word associations” – and again, word associations and production of language were co-located in the frontal lobe. As such, I very much believed “word associations” were key to the actual production of language in children with autism. Note also, that this exercise made use of “categorization functions” and the understanding of language – functions co-located in the temporal lobe.

I now understood why “Sesame Street”, the Children’s Television Network program, had been such an invaluable teaching tool for these children... in this program – especially the “older ones” in my opinion - letters always seemed to be “associated” with something and “moving”. Word associations, language production and motion functions were all co-located in the frontal lobe. “Sesame Street” also often made use of “rhyming words”... another thing that, in my opinion, was also very important in these children given the importance of “auditory processing” and language comprehension functions and the fact that these were co-located in the temporal lobe. It was also because of this co-location of auditory processing and the understanding of language that I believed Zachary absolutely adored onomatopoeias.

I would also make use of colors and motions if I had to “start over” given what I now knew. I knew for a fact that Zachary absolutely loved colors. Motion functions were co-located in the frontal lobe with word associations and language production functions. Word associations, I believed, provided that critical bridge between the frontal and temporal lobes when it came “combining” language production (frontal lobe) and understanding (temporal lobe) functions. Finally, I would also use smells as much as possible. For example, in saying “a is for apple”, I would certainly provide the smell of an actual apple and cake for additional reinforcement. For “b say buh as in banana”, I would use bananas, for “c”, cupcakes or cherries, for “d”, a

dandelion, for “e”, an egg, for “f” a flower, for “g” grass, etc. Certainly, there were smells that could be found to reinforce the concept of letters and phonics.

Of course, at first, I would probably just focus on word associations and the “phonics” for each letter – with as much color as possible - and, then, introduce smells and motions. Motions could be introduced by either drawing the letter, or by using body parts to show how the body could be used to “make the letter”. Colors certainly were easy enough to introduce via the use of crayons, Rainbow Stix, etc. I certainly encouraged parents to help hold the crayons and have the child draw the letters. Again, writing was something we had a very slow start with and I certainly came to regret that.

To understand “the alphabet” each letter’s “label” had to be understood as such – a label. For example, this symbol – A – had to be understood as a “label” of something called “A”. That certainly had to sound “obvious” to everyone, however, with Zachary, I had assumed he “just knew” so many of these things – and assuming he knew something was a mistake I had often made. Over and over I had seen parents of children with autism state that their children could read but had no understanding of the alphabet... and in my opinion, those first building blocks had to be understood clearly – the fact that each letter had its own label and then also the fact that each letter had its own sound(s) in order to allow the child to “break the code” to everything else in language!

Note also that when I did teach Zachary phonics, if a letter, such as the vowels, had two sounds, I introduced both of them at once in order not to confuse Zachary later on down the road... this was very much like the “many ways to make 8” concept.

I encouraged all parents to label everything for their children and to specifically point to objects and name them. Labels were, without a doubt, the one thing that I found most helpful in getting Zachary to finally communicate. I labeled everything for him – and labeling included “counting” as well as “fractions”. As Zachary progressed, it became quite obvious to me that he understood the concept of counting from very early on. I had always counted his fingers and toes as I played with him. But, what also became quite obvious was that word associations were also critical.

If I had to “go back”, in addition to working with labels, I would make use of the concept of opposites. Opposites were in fact word associations that could quite often be very easily acted out or explained. The very nature of opposites – because they were so different – in my opinion, made them one of the easiest things for a child to understand. If you thought about it, even as adults, there were always some words that just “normally” triggered others in language – and “opposites” were certainly the most obvious of those. Below was a list of opposites parents could use to begin to teach concepts and “labels” to their children.

The first list showed basic opposites only. Given my belief that these children very much needed to be provided with the “in between” situation, the second list provides examples of “in between” for each extreme, or “other options” that could be used in order to increase flexibility in these children and help them expand their view of the world to something more than just “this way” or “that”.

## Opposites...

all	none
awake	asleep
big	small
black	white
city	country
clean	dirty
day	night
earth	sky
empty	full
fast	slow
first	last
fixed	broken
forward	backward
front	back
girl	boy
go	stop
good	bad
happy	sad
high	low
hot	cold
in	out
inside	outside
left	right
light	dark
light	heavy
morning	night
near	far
on	off
open	close
over	under
push	pull
quiet	loud
smooth	rough
soft	hard
stand	sit
start	finish
straight	crooked
sun	moon
sunny	rainy
sweet	sour
tall	short
top	bottom
up	down
wet	dry

Obviously, there were many, many other opposites that could be used also.

The following website offered a list of “opposites” books for parents who were interested in that for additional reinforcement: <http://www.mrsmcgowan.com/books/opposites.htm>.

There were also videos that taught opposites – such as those discussed in my second book, *Breaking The Code To Remove The Shackles Of Autism: When The Parts Are Not Understood And The Whole Is Lost!* To this day, the videos discussed in that book, ***especially the “Miracle of Mozart ABCs” - what I refer to as the “alphabet train video”***, were among Zachary’s favorites. Of all the resources I had used for Zachary, this video, I was convinced had been absolutely key in helping Zachary to understand the alphabet! This video had lots of color, motion, music, spinning letters and showed how the parts (each letter) was included in the whole (the alphabet train) as each letter was “loaded” on a separate train car – all these things I knew to be very important to Zachary – even the spinning – and at times, even “negatives” could be used to your advantage! The “alphabet train video” – entitled ***Miracle Of Mozart ABCs*** could be purchased by going to the following website: <http://www.babyscapes.com/ourvideos.html>.

He just never seemed to get tired of certain videos – especially this one! The beauty of such videos was in that not only did they provide a great tool for learning – they also provided for a much needed break for parents – and that too, was absolutely golden!

I had a rather extensive library of videos for Zachary and I cautioned parents against allowing their children to watch the same one or two videos only. In my opinion, variety was absolutely necessary in this area as well as all others in life. Once in a while, however, I would put these on for Zachary “just for fun” since I knew he still enjoyed them. Excellent videos, including opposites and many others I personally used, could be found at on both the Babyscapes website and this one: <http://www.small-fry.com/babfrim.html>.

Certainly, there were many, many other children’s videos available. These were simply the ones I was personally familiar with. ***Always keep in mind that your local library or school most likely also had materials such as these that you could borrow for free.*** Books and videos could get expensive rather fast and as such, local libraries and schools certainly should not be forgotten as valuable resources.

In my third book, I had also stated that the computer, in my opinion, was a medical necessity for these children because unlike so many “other methods”, the computer activated almost all major parts of the brain – at once – and hence, when several parts of the brain were working at “breaking the code” at once, chances of doing so, in my opinion, were greatly enhanced. Furthermore, I very much believed that the computer was an ideal tool for helping to rebuild severed connections among the various parts of the brain because of this fact that computers could activate so much of the brain – at once!

I also found that in working with “in between” it was best to once again define them for Zachary. For example, in working with “hot” and “cold” opposites, to address the “in between”, I started by saying that some things were “not hot” and “not cold”... that they were “in the middle” and that “in the middle” of “hot” and “cold” was “warm”. This “in the middle” was a concept I used for teaching Zachary many, many things as it helped me to define the “in

between” the two extremes. To teach “degrees” of something or the “in the middle” situation, I used words like:

big	bigger	biggest
clean	cleaner	cleanest
close	closer	closest
dark	darker	darkest
dirty	dirtier	dirtiest
easy	easier	easiest
far	farther	farthest
funny	funnier	funniest
happy	happier	happiest
hard	harder	hardest
hungry	hungrier	hungriest
short	shorter	shortest
small	smaller	smallest
soft	softer	softest
tall	taller	tallest
wet	wetter	wettest

Again, there were countless examples like these that could be used to show that there existed “in between situations”. I then provided further examples of “in between” by expanding “degrees” of something as follows:

big	very big	very, very big	very, very, very big	very, very, very, very big	very, very, very, very, very big
small	very small	very, very, very small	very, very, very, very small	very, very, very, very, very small	very, very, very, very, very, very small

Again, countless examples like this could easily be used to show “degrees” of something in order to help a child see that there was more than “just opposites” in life and that “in between” did exist. Whenever possible, I used motion, visuals and varying tones of voice as I showed Zachary examples of “in between” or “degrees of something”.

***Another thing I wanted to mention, as it related to “opposites”, had to do with “negatives in opposites” as they related to anything having to do with “emotions”.***

***Personally, I found Zachary had in the past had a very, very difficult time dealing with “negative emotions”.*** Just the mention of the word “sad” was enough to cause him great distress in the past. As such, if I had to do this again, I certainly would be cautious of that and leave “negative emotions” for last and when opposites involving words like “happy” and “sad” were used, I encouraged parents to make sure they ended with “happy” or the “positives” and very much indicated they were “happy” before attempting to move on to something else. For Zachary, such a small thing had proved to be a huge issue in the past.

Also, for things involving opposites like “open” or “close”, I found that teaching Zachary fractions was invaluable. Zachary had a constant need to have things be either opened or closed, on or off, etc. Again, for him, there could not be an “in between” for a very long time – until I taught him otherwise. Teaching Zachary fractions was invaluable here as I showed him how a door could be “half open” or “one third open”, etc. The tool I used, the Fraction Stax, discussed in my second book, *Breaking The Code To Remove The Shackles Of Autism: When The Parts Are Not Understood And The Whole Is Lost!*, was invaluable in teaching Zachary about fractions. I encouraged all parents to read this text as it provided more information on the importance of teaching fractions and provided many of the exercises I used in working with Zachary in the past.

I wanted to caution parents that in all likelihood, their children would experience frustration in doing some of these simple exercises. With Zachary, I had found that anything other than “the extremes” had been difficult to accept at first. Yet, as Zachary came to understand the concept of “in between” existing in life, the implications of this for his daily life in general, in my opinion, were absolutely huge as the concept of “in between” allowed me to move Zachary further and further away from his need for “rigidity” and “sameness” in everything. Things no longer had to be just “this way” or “that way” – they could finally be “more flexible” and as such, in my opinion, teaching children with autism “degrees of something” was absolutely critical.

Opposites were absolutely one of the easiest concepts to teach a child, but I certainly believed it was also important to quickly move away from the “extremes” in life. Opposites - by definition - were “extremes”. Thus, this could be a double-edged sword. In my opinion, opposites provided a valuable tool for parents. Children with autism were children who lived in a world of “extremes” and as such, in order to reach these children, I believed you had to do so in a manner they would not object to and that meant working with “extremes” to break through the initial shell. Parents had to learn how to take advantage of those things that could be the most frustrating in life – like the need for sameness and extremes in these children - in order to begin communicating with them, but, likewise, they had to learn to provide those “other options” too in order to move the child away from that life of extremes.

Therefore, I saw “opposites” as a potentially powerful first tool in communication, but one with potential pitfalls if used “too much”. We seemed to naturally have a tendency to live a life of “opposites”. Things were usually “this way or that”, “a yes or a no”, etc. Children with autism, however, took that natural tendency to an extreme and it was this life of extremes that had to be broken away from. The more I worked with Zachary, the clearer it became to me that in order to move him away from his life of rigidity and sameness, I had to introduce the concept of “degrees” to everything in life and thus, introduce flexibility – not constant routine! In my opinion, some routine could certainly help in a learning situation, however, the simple fact that these children liked routines only further showed me that this was exactly the problem with these children and that in order to overcome this issue, the answer, in my opinion, was not “more routine” but less of it and as such, “more flexibility” became critical in everything I did with Zachary.

I knew there were many in the field of psychology that strongly advocated “routines” for these children. Yet, in my opinion, based on everything I had seen in my son, I knew that for Zachary, sameness in everything was exactly what he did not need. Any good psychologist knew that a counseling session, when done properly, was a lot of work. It was not unusual for both patient and counselor to be completely exhausted after a counseling session. Likewise, working with Zachary was a lot of work for both him and I. If things were “too easy” – as they usually were when things were “the same” or “routine” – I knew I was not addressing Zachary’s underlying issues. If there was one thing I had learned it was that it was when things were difficult for Zachary that I knew I was “pushing the right buttons” and getting at the bottom of the problem. There was no doubt that this involved frustration for Zachary. Yet, the key was not to avoid frustration but rather to teach him how to deal with it and eventually, overcome it.

As with so much in children with autism, emotions were also very much “a matter of extremes”. This was an issue I had addressed in my second book, *Breaking The Code To Remove The Shackles Of Autism: When The Parts Are Not Understood And The Whole Is Lost!* In Zachary, I had noticed some time ago that when he was sad, he was very, very, very sad. There was no “a little bit sad” in the past. As such, as with everything else, I had started to teach Zachary that there could be “degrees of emotions” – that a person could be a little bit happy, or happier, or very, very happy, or very, very, very, very happy. Again, I cautioned parents against “teaching emotion” by using degrees of “sad”. Negative emotions, in my opinion, were something that had to be addressed very, very carefully.

There was no doubt that depression was often found in those suffering from mental illness and children with autism were no exception to that. As such, I certainly did not want to “teach Zachary” to be “very sad” or “very, very, very sad”. Once Zachary had an understanding of “happy” and the many degrees of happy, I could slowly tackle the issue of dealing with negative emotions, but only did so, very, very slowly, always making sure that I ended on a very happy note with Zachary. In my opinion, there could be no denying that this area of “negative emotions” and teaching a child with autism how to deal with those negative emotions was an area that had the potential to do great harm if not handled very slowly and cautiously.

***In my opinion, the potential for depression was absolutely there because of this issue with “extremes” in everything and as such, I knew that in working with Zachary, I had to be very careful and very attentive to his needs when it came to dealing with negative emotions. Even the smallest of negative emotions had the potential to become a very deeply felt, very negative emotion in Zachary and the implications of that, I knew, were tremendous.***

I had no doubt that trivial, every day situations, for the child with autism, could become a matter of extreme emotions in no time at all – be those very positive or very negative emotions. And, as such, I knew I had to teach Zachary how to deal with life and that meant how to deal with negative emotions too. This was one area that certainly required a great deal of patience and understanding – and time – and it was an area I found myself constantly working on with Zachary. If I sensed even the slightest amount of stress or any negative emotion in Zachary, I knew it had the potential to explode into a very bad situation and as such, when such moments surfaced, I was quick to drop whatever I was doing and go comfort Zachary, by either helping

him with the task presenting the difficulty (i.e., an educational software, etc.) and/or using “words to cope” as described in my second book.

“Words to cope” were small phrases I had found helped Zachary tremendously in moments of stress and frustration. The key thing here was that the “words to cope” had to be uttered by Zachary himself. Note that language production (the actual verbalization of something) and the control of emotions were co-located in the frontal lobe. As such, hearing “words to cope”, although that could draw on “word associations”, in my opinion, was not nearly as valuable as having the child utter these words – themselves! Note that auditory processing (i.e., hearing) was in the temporal lobe – not in the frontal lobe and it was in the frontal lobe that “control of emotion” functions were located – along, by the way – with the sense of self. As such, positive utterances about “myself” – literally uttered by the child – such as “I can do it”... or “I’m good at this” were also, in my opinion, critical to the control of emotion and the building of a strong concept of self.

Using “words to cope” was a simple thing to do. These simple phrases included things like: “it’s ok... just try again” or “it’s ok... just ask for help”... or “it’s ok... mommy can help Zachary”, or “you can do it...”, or “I can do it”, etc. Small phrases like these became invaluable in helping Zachary deal with his negative emotions when they did surface as well as in “building his concept of self”. Note that in children with difficulties with pronoun usage, it was, again, critical to make use of correct pronouns in using “words to cope”... such as “I can do it” being said instead of “you can do it”... although, obviously, hearing the parent reinforce the child’s concept of self was also invaluable – provided the child understood the difference between “you” and “I”. I had always used “words to cope” and it was only much later that I realized the importance of these small phrases and also, the importance of proper pronoun usage – as such, I encouraged parents to be very careful of proper pronoun usage in using these small phrases.

Negative emotions were not something I “taught” very much for obvious reasons. At most, I would teach: “This is a sad mom” or “I’m so sad”. However, I did not go into “degrees” that would bring Zachary to the very negative end of the emotion spectrum. For example, I would never “teach” something like “I’m very, very, very, very sad”. Never did I use more than “one very” to teach Zachary anything having to do with “negative emotions”. Instead, given I knew he understood all too well the concept of “sad”, whenever Zachary was “sad”, I used the opportunity to bring him from the “very sad” extreme to something more in the middle.

For example, if sad, I would tell Zachary, “let’s be happy” and work with the word “happy” – the opposite – to have Zachary make the necessary association to bring him back to a better state of mind. As I did this, I played with him with my “tickle fingers” or anything else I knew he loved to do. Control of emotions was certainly an area where favorite treats were a must. I knew the sense of smell, motor functions and word association functions were co-located in the frontal lobe along with control of emotions and as such, anything having to do with taste and/or smell, motion or word associations (i.e., using the word “happy” to overcome “sad”) usually worked quite well in helping to overcome negative emotions. Negative emotions were certainly one area in which I was very, very cautious and used “opposite positive emotions” to my advantage.



When Zachary was “sad”, I was careful ***not*** to say something like: “are you sad... don’t be sad” since I knew ***that would only make him focus on the word “sad” and further complicate the situation as the focus on that word – “sad” - became a self-fulfilling prophecy and made Zachary even “more sad” to the point of dropping him into the realm of extreme sadness. As such, any “sadness” was countered with a focus on the opposite emotion – happy – in order to move Zachary back into that direction. Thus, instead of saying: “don’t be sad”, the appropriate response was “let’s be happy” or “let’s do something funny” as I physically tried to do “something funny” with Zachary. Often, just using my fingers to make a “happy face” as I raised the corners of my lips and smiled worked quite well too. The idea was simply to focus on the positive opposite emotion via word associations, motions, the use of favorite colors, shapes, etc. and move away from the negative emotion!***

Routines certainly provided for “sameness” not only in environment but in emotions too. As such, I was not surprised that children with autism preferred routines and appeared to respond well to them. But, again, this was a double-edged sword, as routines, in my opinion, did not address the underlying issues in these children – the issue of need for “sameness” in everything. ***Routines only reinforced inflexibility – and, inflexibility, in my opinion, was exactly what these children did not need more of!***

Although there could certainly be difficult times, to leave Zachary in his “comfort zone”, in his world of “sameness” did absolutely nothing to address his issues and in order for me to move him past this lack of flexibility, I had learned I needed to introduce flexibility as much as possible in his life. There certainly were plenty of ways to introduce flexibility and “degrees” in life in ways that were fun. Teaching the concept of flexibility via exercises involving “big, bigger and biggest”, etc., had been one of the most “stress free” ways I had found in terms of introducing flexibility in Zachary’s life. Such exercises basically involved using the same word in only a slightly different way and for Zachary, such words had provided both “sameness” and “flexibility” all rolled into one. The words themselves were “similar enough” to reduce Zachary’s stress levels while I taught him that things could indeed change. As such, I could ***“ease him into flexibility”*** by using exercises that presented ***“shades of the same thing”*** - exercises that provided variety but with a “flare of sameness still mixed in” that provided help in controlling emotions as flexibility was learned.

Words like “big”, “bigger”, “biggest” were truly ideal. They were similar enough in sound to give Zachary that “feel of sameness” but allowed for the introduction of variety and change as well and once Zachary understood the concept that things could have various degrees, life became much simpler. It was then much easier to apply the concept of “degrees” to many, many other aspects of life.

Life was anything but routine and as such, in my view, to allow Zachary to live a life of routines and extremes only placed him in an artificial bubble that certainly would burst at some point in time and I knew that the longer that artificial bubble was allowed to exist, the worse the outcome when its pressure finally would be released and that “burst” occurred. For me, putting Zachary in an artificial bubble was not an option. The only option was to make him understand his world and as with so much, labeling everything for him – including “degrees” of something – had made a tremendous difference in his ability to cope with everyday life.

As with so much in life, achieving proper balance was always important. Yet, when a child had no understanding of his world and had tremendous difficulty in communicating, obviously, making that “first crack” in the shell was critical and in my opinion, “opposites” certainly could be useful in accomplishing that. I just cautioned parents to keep “opposites” in perspective when it came to “extremes” and the need to provide “alternatives” and “flexibility” by moving away from “opposites only” as quickly as possible.

In addition to using “opposites” in trying to reach a child with autism, numbers/counting, shapes and colors were also excellent tools to use. Each of these things provided for constants that could be used to one’s advantage in initial communication attempts. I discussed numbers, counting, shapes, colors, etc. in my previous books and as such encouraged all parents to read my previous works for more on those issues. Briefly, however, what I saw as key in these topics was the fact that these things provided for a degree of “sameness” also and as such, I was certain that had been the reason Zachary had so loved working with these things.

For example, shapes never changed. A circle was always a circle, a square always a square, a hexagon, always a hexagon. Once Zachary knew his shapes, he knew they remained fairly constant with basically only changes in size and color – but never in shape. As such, again, this brought stability to his world. Shapes were something that were easily understood. The same was true of numbers and counting. A “2” always looked the same and always had the same “number of things” associated with it – like 2 fingers, 2 spoons, etc. Counting was always pretty much the same also. The number 1 was always followed by 2, the number 2 was always followed by 3, etc. These things remained pretty much the same all the time and as such, these were things that were easy for Zachary to learn.

Yet, again, as with everything else in life, so, too, did these things have to move from the “this way” or “that way” as quickly as possible. Once Zachary knew how to count “by ones”, I moved on to counting “by twos” to show him that even math could change. I did the same thing with shapes. Once Zachary knew his basic shapes, I showed him how combining shapes could make new shapes. For example, a triangle on top of a square made a pentagon or “a house”. Two triangles joined together at the base made a diamond. Three circles on top of one another made a snowman. In everything, I always tried to make Zachary see things in a different light in order to help expand his thinking and get away from that world of “this way” or “that way” only. Once I understood the issues, it became much simpler to address them in pretty well all aspects of life.

The key to so much in teaching Zachary and helping him to control his emotions was really a matter of learning to identify those things I could use to my advantage based on his need for sameness. Without control of emotions, there could be no learning and as such, I always had to be careful to bring Zachary’s emotions back under control quickly whenever that control was lost. Again, knowing what to use to my advantage was key – opposites, shapes, counting, food, word associations, words to cope, motions, and colors – all of these were things I was able to use to help Zachary during moments of stress.

As I looked back on Zachary's language development, there was no doubt that if I had to do it again, I would focus on word associations, including letter/sound/phonics associations for the alphabet, opposites, degrees of something, etc., first.

When Zachary had first started to talk there was no denying that labels had played a huge role in his life – as they did in the development of language in any child. For a very long time, Zachary seemed to talk only in labels. Of course, he finally learned that a label could also be used as a command. I had failed to recognize that this too could be used to my advantage.

Zachary knew labels, such as “milk” (for rice milk). He soon came to recognize that a label could be something to represent an object in and of itself but that it could also act as a command in order to “get something”. Zachary quickly learned to speak in commands and for quite some time, he spoke only in labels and commands. What I had not realized for quite some time, however, was that “degrees” of labels, “degrees of commands” and indeed, “degrees of speech” or “flexibility in speech” also had to be taught.

For Zachary, there was only one way to ask for milk, only one way to ask for rice crackers, only one way to ask for anything. I soon realized that again, herein was the problem. Zachary's “all or nothing” extended into his speech as well. There was one way to say something and that was pretty well it. Again, he had to be taught “flexibility” in speech. I had spent a great deal of time labeling things for Zachary. He could certainly talk in labels and commands and did so for quite some time. Yet, the one thing I had longed for, conversation, had taken a very, very long time to come about.

Zachary was now at the point where he could easily answer questions with either a “yes”, “no” or short sentence. His “statements” now included up to eight words quite often. Yet, he certainly was not able to “tell me a story” for example, or tell me about his day, etc. For now, conversation was limited to small question/answer sessions. When I first worked with Zachary, trying to move him past talking in labels and commands, I had noticed that he appeared unable to remember more than a few words at a time.

If I gave Zachary a sentence and told him something like, say: “Mom, I would like to have spaghetti and rice milk for lunch today”, he simply could not do it. He was able to say the first few words, maybe two to four of them, but had extreme difficulty in repeating the sentence he had just heard. Yet, I knew Zachary had a fantastic memory. I usually had to label something only once for him and he remembered it. It was the same thing with spelling. He was a fantastic speller and I used spelling a great deal as I taught him new things. When a new label for anything was provided, I usually made sure I spelled the word for Zachary also. Thus, I found myself with a son I knew to have a fantastic memory, and yet, he had difficulty with repeating even basic sentences he had just heard less than five seconds before. I wondered if this was just a matter of short-term memory issues or working memory issues. The more I thought about this issue, however, the more I became convinced that for Zachary, that was only a problem – in some cases – but not all. If a task involved anything that could be categorized, including something he had heard in the past, he appeared to have a fantastic short-term, long-term and working memory. Thus, if only a “memory issue”, he would not have been able to

remember anything, yet, clearly, he could remember labels, commands, spelling of words, etc. – all things that very much involved categorizations!

As I continued to work with Zachary, I decided to try “bubble graphs” to teach him about sentences and how to remember them. I discussed the issue of bubble graphs at great length in my second book, *Breaking The Code To Remove The Shackles Of Autism: When The Parts Are Not Understood And The Whole Is Lost!* and had reproduced that section of my second book earlier in this text as well.

Although “bubble graphs” worked tremendously in helping Zachary to remember sentences, I later realized that “something else” was needed. This “something else” would be the focus of the rest of this text.

Basically, as explained previously, a “bubble graph” was simply a way of compartmentalizing a sentence visually. I had been taught to use bubble graphs when I was a child in fourth grade. I had modified the concept in order to adapt it specifically to Zachary and autism. As my journey with autism continued to unfold, I now came to understand that language functions were found in various parts of the brain. For example, the production of language was co-located in the frontal lobe along with word associations. Yet, the understanding of language was co-located in the temporal lobe along with categorization functions.

Given I believed co-located functions to be much more inter-related than we may have ever imagined, I believed that sentences had to be categorized in order for Zachary to understand them. Note that memory functions were also found in the temporal lobe. The production of language, however, was another issue. Production of language – or, - some of those functions involved in actually speaking - were co-located with word associations in the frontal lobe. Thus, word associations (frontal lobe function), such as opposites, in my opinion, provided a means of categorization (temporal lobe function) and hence, a bridge between the frontal and temporal lobes given that word associations, by definition, were a form of categorization – and that, I believed had to be the key to getting both language production and language comprehension to finally “work together”.

Note that the frontal lobe also included functions relating to smell and motion. The cerebellum – a part of the brain located at the back of the head just above the neck – was very much known to be affected in children with autism and this particular part of the brain was best known for the coordination of motor functions. Yet, research was beginning to indicate that the cerebellum appeared to play a role in higher thought processes, language and emotion as well – all functions also – at least to an extent – located in the frontal lobe along with language production. The physical size of the cerebellum was clearly documented to be smaller in children with autism – I now very much suspected due to mercury exposure given it was known that mercury had its most devastating effects on developing or immature cells. The cerebellum was also now known to take over twenty (20) years to mature (see *Breaking The Code: Putting Pieces In Place!*) and as such, this, in my opinion, certainly would make the cerebellum perhaps among the cells most susceptible to mercury damage. Yet, although I knew the cerebellum to be clearly impacted in children with autism, the fact that this part of the brain continued to develop for over twenty (20)

years also offered hope for these children. Functions in the cerebellum were also very much considered “learned functions” and language certainly was a “learned function”.

Granted, language was best learned prior to age five. Yet, I simply had to believe that given the cerebellum continued to change and develop for twenty years, and the fact that people could indeed learn to communicate in a second language even after that time, given that – I felt there was still hope even for those who were much older and still non-verbal. Communication involved many forms – verbal as well as non-verbal – and since motor functions were co-located with language production, surely, even for those most devastated by autism – there had to be a chance of communicating via tools such as sign language – something that could involve both word associations (i.e., up/down) and motions – all at once.

The key to understanding “how to build sentences”, for Zachary, and I suspected many others, appeared to be the use of – categorization functions.

In order to categorize a sentence, I decided to make use of various shapes and colors – two things I knew Zachary absolutely loved. Again, the trick in teaching Zachary so many things was really to work with those things I knew he had an interest in – and that certainly included shapes and colors. That was how I had come up with my “bubble graphs”. There was absolutely no doubt that for Zachary, this had provided a critical link for issues of “language”. This had also shown me that – at least in matters that involved categorization - the issue was not one of working memory or short-term or long-term memory. Zachary had easily been able to remember the sentences as we worked on them, a few days later, a few weeks later, a few months later and several months later as well. To this day, Zachary was able to remember the sentences I had first written in my bubble graphs. Thus, clearly, for Zachary, the issue had not been one of memory.

Yet, conversation still had not flourished as I thought it should after our initial use of bubble graphs. Yes, it had improved significantly... but, somehow, I felt I was missing something. Granted, I had not used them much in the past months as I worked on other issues with Zachary in his schoolwork. I had spent the last few months following an actual “first grade program” I had purchased and it was as I had worked through these materials that I had seen so, so many issues with them. As such, in the coming year, I planned on spending more time on materials such as my bubble graphs to teach Zachary more in the area of “how language actually worked” and “how” you actually came to “build a sentence”.

As the weeks and months past and life continued, I finally came to understand “the issue” for Zachary. As he worked next to me on his computer, he now enjoyed many programs that involved second grade reading levels. Some of his software required that he “build a sentence”. Zachary had great difficulty with this. At first, he simply guessed as he clicked on words, hoping they would provide the desired answer and the sound of a “correct answer” from his computer. The program asked Zachary to make a sentence by clicking on the correct word to complete the partial sentence already provided. Several words were provided as “choices” to complete the sentence. They included nouns, verbs, adjectives, adverbs, articles, prepositions, etc. – but no instructions!

Zachary would simply click on any word, hoping it would complete the sentence and allow him to move on. Many times, his guesses obviously allowed him to do that – but many times, obviously, they did not.

It was as Zachary worked on this computer program and experienced frustration that he started saying to me: *“Mom, I need a sentence... make a sentence please”*. ***And herein was what I now believed to be yet another key to the tremendous conversation delays in children with autism.***

My “bubble graphs” had provided the sentence for Zachary – ready made. What they failed to do, however, was to show Zachary how to make a sentence. Given he needed to be shown how things worked, clearly, that had to also be true of conversation. Zachary had to understand how the parts formed the whole to conversation, too, and that meant he had to have an understanding of *“how to build sentences”*.

***The building of sentences was something we “just assumed” happened in children as they heard conversation all about them. Yet, conversation had no pattern to it and until the parts to the whole were defined for Zachary, I was certain he would continue to have difficulty in “making a sentence”. He certainly could understand and read a sentence once it was provided – either on the written page or in the spoken word – he just had no idea as to “how to build one” from scratch! Thus, he had to use sentences he had previously heard in his life in order to have “conversation”. Until he learned that he could modify those sentences he had once heard, again, his life – even in conversation – was a matter of “this way” or “that” with no in between!***

Zachary could modify previously heard sentences, but building “good and – new - sentences” from scratch was still a challenge for him.

Thus, my “bubble graphs” had provided a good first step – categorization – a function co-located with the understanding of language in the temporal lobe. But now, the next part was needed. I had to show Zachary how to make a sentence – from scratch – and show him in a manner that allowed him to see that there could be flexibility in sentence building, too!

Given there were countless ways to make a sentence, I had to come up with a system that would allow for flexibility yet would not lose the concept of “bubble graph” categorization to help with the understanding of language. And, I also knew that if I wanted “language production”, I would have to somehow make use of “word associations” too in order to bridge language production and comprehension functions located in the frontal and temporal lobes, respectively.

A challenge – yes – but, not insurmountable! So, how do you teach a five year old how to build a sentence – from scratch – with an understanding of “the parts involved”, in a manner that was not too difficult to understand and a manner that would still captivate his attention, focus and interest? Again, I knew the “bubble graph” concept would be key. Instead of providing a “ready made sentence” for Zachary, I would simply show him the parts and how to put them together to make a sentence – in a flexible and fun way.

This certainly took me back a ways... back to early grade school – and the basics of grammar. Yet, the goal was not to teach Zachary “all the grammar rules” – but rather – to simply teach him “the basics” of making a sentence in the hopes that understanding “how sentences were made” would help increase conversation skills. I did find comfort in knowing that Zachary was very much a “left brain” person – and that meant he liked “rules” to things. Certainly, that would come in quite handy in teaching language skills and all that grammar further down the road. That also meant he would have a greater focus on parts and be more analytical. The beauty of the “bubble graph” system, however, was that it had aspects to it that appealed to both sides of the brain and as such, in my opinion, it was truly the perfect tool for teaching the basics of language when it came to the building of sentences.

For those who were left-brain dominant as was Zachary – and I suspected, most boys – bubble graphs could draw on rules, “parts to the sentence”, analytical skills, auditory skills, and sequential processes. Yet, for the right brain dominant child, bubble graphs provided a method that could draw on the need for concretes, a view of “the whole” in showing how it all fit together, use of tone voice, use of motions, and visual-spatial as well as visual-motor functions.

So, what were “the basics” Zachary needed to understand in order to build a sentence and also in order to help increase conversation skills overall. I certainly was no language teacher, but, even I knew “the basics” I felt Zachary needed to understand.

At the very minimum, he had to understand the parts to a sentence: A noun, pronoun, subject, adjective, article, verb, adverb, conjunction, preposition, and prepositional phrase.

He also had to understand that there were different types of sentences: Commands, exclamations, questions (and answers), and statements of fact - and that – when you thought about it – really involved putting all these different kinds of sentences together in a way that made sense. He had to understand that if asked a question, he was expected not to repeat it – but to provide an answer. I had already started to work on this issue with him on some of our walks. I would say to him, for example, “the question is... what is in that tree?”. Then, I would prompt him for the answer by defining the answer as that – “an answer” and saying: “The answer is... there’s a bird in that tree”. This way, I not only labeled “a question” and “an answer”, but also provided examples for him. I could then drop the “the answer is” part and just give him examples of “answers” to questions by saying, for example, “There’s a bird in that tree”.

We had only recently started these exercises on our walks and I knew, already, they were helping Zachary in understanding conversation. As with everything, it was so critical to label everything – to tell Zachary the “this is the question” and “this is the answer” and to define each as exactly that – a question, an answer, a statement, an exclamation, etc. This sounded complicated, but it really was not that difficult to do. In so much of what I had done with Zachary, initially, it seemed like there was “so much” involved in teaching him everything. But, once I finally figured out “how” I had to teach Zachary, there was no denying that life became much, much simpler. Granted, there was a little more “upfront” work involved, yet, the way I looked at it, I could either do that little extra upfront work or deal with ongoing frustration because that little extra upfront had not been provided. I simply resolved to do the little extra

upfront work rather than have both Zachary and I experience constant frustration as I attempted to teach him new things.

Sentence parts certainly would be “a new thing” to teach Zachary – and I had to do it in a fun way that was easy enough for him to understand and taught him how to build a sentence – from scratch! First, there had to be some definition of basic terms, again, in a fun, easy to understand way.

Before getting into the specifics of exercises I made for Zachary, there were a few things I wanted to mention. First, in defining “a person”, obviously, some children would not understand terms like “mechanic” or “aunt” or “musician”, etc. As such, I encouraged all parents to make sure they defined all new words for their children. Whenever I gave Zachary a new “person word” such as this, I always defined it simply by using - *equations*.

For example, to define “aunt”, I told Zachary “aunt = mommy or daddy’s sister”, “grandpa = daddy’s dad or mommy’s dad”. Likewise, a “mechanic” was easily defined as “a mechanic = someone who fixes cars and trucks”, a “musician” as “a musician = someone that makes music with a piano, a guitar, a flute or other instrument”, and so on. Again, for Zachary, making use of that “*equal to*” was always important in helping him to understand things initially. As he caught on to the “system of definitions”, I could then easily “drop the equals” and just start defining terms normally by saying for example: “a construction worker is a person that makes houses or builds roads and things like that”. I still often used “equals” in explaining things to Zachary, but clearly, Zachary was now at a point where I could easily start moving away from that in conversation.

Although Zachary already understood the concept of “man”, “woman”, “girl” and “boy”, I knew he still had difficulties with answering questions asking: “who is that person...?”. This was why I decided to include the “Who Is That?” in my exercises. Likewise, I would use “what, when, where and how” to help define other things for Zachary in order to help him understand the parts to a sentence and how they fit together. Associating “who” with my “person definition page”, etc. was just my way of starting to help Zachary build those critical word associations to help him with “who, what, when, where, why, how”, etc. type questions in the future.

In order to show children with autism “what a person was”, I decided to use a mixture of pictures that were lifelike as well as caricatures. Zachary already understood “man”, “woman”, “girl” and “boy”, but I knew that was not the case for many children with autism. To me, providing as “lifelike” a representation as possible, at least initially, was key in accomplishing that. This was also critical in helping to reinforce “real vs non-real”. In my opinion, it was important to always distinguish that for Zachary, and I suspected, it would be for other children too – at least initially.

Note that I did not tell Zachary that a picture of a person was “a real person” – I referred to it as “a picture of a boy or girl”, etc., and emphasized that it was only a piece of paper showing what a person looked like. As such, picture of “lifelike” people were used to help solidify the concept of “boy, girl, woman and man”, but, the pictures were always identified as “just that” – pictures!



“Real people” were persons you could physically touch, for example. Granted, there could be “real people” on tv, however, you could not “touch a person” on a tv and know this to be “a person” and this, again, even though a “subtle difference” was, in my opinion, a very critical difference indeed in terms of providing that all important “reference” for Zachary – a child I very much knew to “live via references”. For a great deal more on this issue, I urged parents to read both my second and third books.

Given I had noticed and addressed this issue of “real vs non-real” or “real vs pretend” – and indeed continued to do so if I saw any hint of Zachary assimilating the two a little too much for my comfort level - Zachary now had a very good understanding of “the difference”. Although Zachary now had a good understanding of that difference, “real vs pretend” was something I always kept a very careful eye on and as such in order to prevent confusion in young children who did not have a good understanding of the difference, I wanted to provide for parents interested in trying some of these ideas something I felt would create the least amount of confusion in a child with autism.

Parents who had not read my previous works were encouraged to do so in order to understand my concerns with the issue of “pretending” and the difficulties in distinguishing between the “real and non-real” as I had seen this issue in my own son. This issue was discussed at length in both my second and third books. Both those books were posted in full, on my website: <http://www.autismhelpforyou.com>.

Note also that colors and variations in shapes, and lines (i.e., dashed, solid, etc.) were also used. Again, this was simply my way of helping Zachary build associations as I worked to teach him how to make a sentence – from scratch. For Zachary, these were effective, simple ways to help build not only associations, but categories as well. By providing “hints” such as these for Zachary, I could keep sentence building “fun” and as such, greatly reduce any stress involved in learning how to build sentences.

The following pages were the actual work pages I decided to use with Zachary. I provided many practice pages as well as examples of “each part” in order to facilitate Zachary’s understanding of these “pieces” to communication. By presenting the materials in the way I did, I knew Zachary would easily see that there could be “many subjects” or “many adjectives” or “many verbs” or “many adverbs” to choose from and that he needed not be limited to a few words in his speech. I could also easily prompt him to “pick a different word” by providing ready-made lists. By allowing him to see the “flexibility” and “choice” in language, I knew that would help him to better understand and use language and help him expand his language skills.

My materials allowed me to just tell Zachary to “pick a verb” or “pick an adverb” or “pick a noun” or “pick an adjective”. By providing many of these for him to pick from, it was easy to show Zachary how easily sentences could be made and/or changed.

My suggestion to parents who wanted to use these sheets was to print them and put them in a binder. Personally, I always put my “concept sheets” in plastic covers. That way, they stayed clean and could be used over and over again as I worked with Zachary. I then made several practice sheets in order to practice the same thing using many, varied examples. Parents who

did not have access to a computer at home, could obviously just learn the concept and teach it to their children without these pages because the concept was a simple one that could be used with any child. All that was really needed was a very basic understanding of grammar, a paper and pencil.

Also, I encouraged parents to “gauge” their speed in going through these materials. It was always so easy to “keep going” and try to get through everything as quickly as possible. Yet, I urged you to take the time to “slow down” and cover just one or two things each day and then review them before going on the next time.

Finally, I urged parents to pay special attention to the section on “pronouns”. Proper pronoun usage was a problem that had very much been identified in children with autism. Given I believed these children lived “via reference”, it was easy to understand why proper pronoun usage was so difficult for these children.

**Pronouns changed based on who was doing the talking.** As such, they were “a moving target” and one not easily understood by children with autism such as Zachary. Yet, proper pronoun usage was absolutely critical not only to proper understanding of language and proper communication, but also, in my opinion, they were absolutely critical to one’s concept of self. After all, if one did not understand who “I was” or who “you were”, how could one have a concept of self when the “I and you” seemed to be constantly changing and if the “I’s and you’s” were so mixed up, why would not the child’s concept of self be “all mixed up, too”!

It had taken me a long time to see this issue in Zachary, partly because I usually referred to him as “Zachary” when speaking to him. Yet, for years, in speaking to Zachary, I had also called him “you” in speaking to him. As such, it made perfect sense for him to think that “you” was just another word for “Zachary”. He did not realize that “you” could also be “me” and that the pronouns “I” and “you” did a “flip flop” based on who was doing the talking and who was doing the listening. As such, of all the areas of speech, proper pronoun usage was something that, in my opinion, was most critical of all, because the implications of improper pronoun usage spanned far, far beyond the inability to communicate properly. Something that perhaps seemed “so trivial” to so many, in my opinion, had an absolutely huge impact on one’s sense of self and understanding of “self”!

Obviously, once a child learned to speak, there were many “rules of grammar and language” to be learned.

My intent here was not to review these rules but rather to simply introduce Zachary to the “concept” of how language worked and to the fact that some words “went together” in speech.

I did not need to be “grammar expert” either. Quite frankly, if I did not know “where to place a word” in the sentence train, it was easy enough to simply draw another “bubble” and “join it” to the train somehow, perhaps with a new shape not already used (i.e., diamond, star, etc.). Although I had a good understanding of grammar, I, personally, was not a grammar expert and I suspected that to be true of most parents. As such, yes, there would be times I knew Zachary would “come up” with a sentence I may not be able to graph 100%, but that was ok. I would

simply do my best and go on – the key was simply to group words that looked like they belonged together – and most of those, I could figure out.

There was a saying in life: “Don’t sweat the small stuff.” And, in my opinion, 100% accuracy in “bubble making” was “small stuff”. Yes, I wanted to do my best to be as accurate as possible, but the goal here was not to increase frustration, it was to alleviate it – and, that, was something I very much urged all parents to keep in mind.

I knew some children would probably prefer to draw the bubbles differently than I had, perhaps, preferring to draw something that looked a lot more like an actual train in terms of “layout”. Again, that was fine. There was absolutely nothing wrong with that. The key, I believed, was just to provide the understanding of “the concept” of language. So, what I was trying to say here was simply to “keep things in perspective” and to always remember not to “sweat the small stuff”. These children had plenty of challenges ahead of them without experiencing additional frustration or worse, reprimand, because they were “not making their bubbles quite right”. I always tried to remember to work **with** Zachary – not against him – and to understand the world as he saw it, because only then could I really help him.

As such, in everything we did, I always looked for “additional clues” in terms of how Zachary perceived the world... and I was certain there would be more as we went through language exercises this year.

My mother had a saying she used to use often: “*Perfection is not of this world*”. I always tried to remember that - not only for Zachary, but for myself as well.

Given Zachary thrived on “rules”, I did not expect “grammar” per se, to be difficult for Zachary. His difficulties, in my opinion, resulted from “not understanding how language worked” in the first place because it was “so random” and as such, my intent here was only to help Zachary understand how “the parts fit into the whole” in order to help him understand “how” people speak and “how to put the words together” to form speech.

I knew that these pages would greatly help Zachary expand his language skills because once he understood the “how” to how language worked, the variation in speech could then follow much more readily.

There were many, many excellent books for teaching grammar as well as many online resources providing actual exercises.

The series I, personally, planned to use for Zachary when I did get into “teaching grammar” specifically, was a series by Wanda C. Phillips entitled Easy Grammar Systems™. These materials provided plenty of repetition and review and provided a good summary of many “rules” also and as such, I felt they would be well accepted by Zachary once the time for “grammar rules and written language” finally did come. Materials by Wanda C. Phillips were available at [www.easygrammar.com](http://www.easygrammar.com).

This year, however, my focus would be “bubble graphs” and “explaining how language worked” to Zachary. To many, my materials probably appeared a little “intensive”. I had always found that for Zachary, once he understood “the concept”, the level of difficulty mattered very little. He could read big words just as well as little words once he understood the “how to say it” in phonics. As such, I always tried to make materials I felt best explained “the concepts” in a way I knew Zachary would grasp easily enough.

The idea behind the following pages was to, at first, just allow Zachary to simply “point to” specific word types based on my request to him, in order to help **me** build a sentence train. Once he saw me do this a few times, I knew he would easily grasp the concept and be able to make “his own sentence trains” by picking words out of the many provided. I provided many words, many nouns, many adjectives, many verbs, many adverbs, many conjunctions, many prepositions, etc., because that way, Zachary could see he had “a choice” and that he needed not limit himself to one or a few words in speaking. By providing “all these word groups” in this manner, it allowed Zachary to again, increase his flexibility in communication by allowing him to pick from one of the many choices available – and that – was a critical key to his understanding and expanding of “speech” or - conversation!

With Zachary, looking back, I felt I had waited “too long” to get started on writing. As such, even though Zachary was making great progress, writing was still somewhat difficult for him. I suspected part of that had to do with some limb apraxia or nerve damage in his fingers.

Zachary had very weak fingers and often dropped his pencil when writing. I now knew that high doses of vitamin B6 were associated with peripheral nerve damage and I suspected that Zachary had experienced some of that as a result of having been on high doses of vitamin B6 earlier on. As such, we also did “finger exercises” to help rebuild his strength. For example, I made him “squish” a sponge ball to rebuild strength in his fingers, however, in my opinion, there was simply no denying that Zachary had some issues with “his fingers”.

It had taken me close to three years to come to understand so many issues in autism, and B6 was one of those issues I had only recently come to understand a lot more. In my opinion, there was no denying that this vitamin was critical to these children. B6 deficiency was something that had been clearly documented to either cause or magnify seizures and so, I knew Zachary certainly needed to have B6. Yet, now, I also knew “too much” certainly had its negative implications, too. There was a great deal more on the role of B6 provided in my third book, *Breaking The Code: Putting Pieces In Place!* This was a text I encouraged all families to read carefully.

I also encouraged parents to look at my link entitled “Teaching Tools”. On this link, I provided additional materials I created and used for teaching Zachary. This would also be where I would add any additional teaching materials in the future.

My point in discussing Zachary’s weak fingers and his issues with writing was simply to raise the issue that it was ok for the parent to do most of the writing in teaching these concepts. Certainly, I wanted Zachary to come to actually fill in his bubble graphs all by himself... and had no doubt that he could do that – to some extent. He just tired easily when it came to writing. I

knew he found it very difficult. He was getting much better at it, but, certainly, it was still not something he enjoyed doing because it did require a lot of work on his part. Writing was something we now practiced quite often... I just wished I had “started earlier” in this area in terms of his communication skills. Not teaching Zachary to write sooner was one of the things I certainly had come to regret although just figuring out how to teach him to hold a pencil had taken a long time. Once he understood that, and knew to “hold the pencil on the crack” as discussed earlier in this text, things certainly had become easier.

So often, when we worked on his homework, I found Zachary knew the answers and should be able to finish a page very quickly. Yet, his difficulties with writing made it such that it took much, much longer to complete some of his homework. I knew we would overcome this issue with time and additional practice however, there was no denying that the actual writing out of an answer could be very trying at times – on both of us. Patience and understanding – words I constantly had to remember. Zachary had come so far and in the big scheme of things, this was “small stuff” and an issue I knew we would soon overcome. :o)

Again, the point to keep in mind was to teach “the concept” of language mechanics in a manner that showed there could be variation and flexibility in word choices. These specific materials were not to make Zachary a perfect writer. There was no denying that “bubble graphs” certainly encouraged him in his writing skills given he simply loved to “fill in the bubbles” and complete the entire “bubble train”.

**The primary goal of these materials, however, was to increase conversation skills – not writing skills and as such, I encouraged parents to remember not to focus on the writing but on the concept of speech.**

Getting “wrapped up” in proper letter formation, etc, in my opinion, would simply take away from the entire purpose of these materials. These were not “writing exercises” per se – they were exercises for building conversation skills and as such, it was the “oral” skills and the “verbalizations” via the “picking of words” that had to be the focus of the lesson – not the perfect writing of an “a” or any other letter. I knew it was very easy to “switch the focus” onto writing skills and I cautioned parents **not** to do that.

Personally, if I found myself “switching the focus” and placing it on “perfect letters or bubbles”, I would simply **take over the writing task** for Zachary. Only by doing so could I **keep the focus on “how language worked”, on “conversation” and the building of oral communication skills** as opposed to writing skills.

Also, if I had a special “note” or comment for parents, I indicated that at the top of the page by defining it as a “Note to parents...”. These were pages for “parent information purposes only” in order to bring to light certain issues. As such, even though there were a few “notes to parents” included, they were not materials to “go over” with a child.

Finally, given the importance of pronouns in speech and indeed, language overall, I provided a small section on pronoun usage. As parents went through all of these materials, the importance of pronouns in speech would become clearly obvious. Indeed, it was not as I actually sat down

and started to make “bubble graphs” that I realized how truly important pronouns really were in language. It had been clearly documented that children with autism exhibited “pronoun confusion”. Given I firmly believed these children to “live via reference” (see book 2 and book 3 for more on this critical issue), there was no doubt in my mind that Zachary’s confusion over pronoun usage only further magnified issues with a poor concept of self as well. As such, I encouraged all parents to spend a great deal of time on proper pronoun usage, as I truly felt it was key not only to the development of language but also to the development of a stronger concept of self in children with autism. As I had stated earlier, if one had no understanding of “you, me, I”, etc., how could one possibly have an understanding of “himself” or “herself” in relation to others?

I also encouraged parents to make use of their child’s name or of the word “mommy” or “daddy” where pronouns would be used in normal speech. I had not realized that Zachary had such issues with pronoun usage until after I had read about this issue in children with autism. Most of the time, as I spoke to Zachary when he was younger, I had made use of his name instead of pronouns in order to help him understand “his name”. For example, I would say: “Zachary, put that on Zachary’s bed” instead of saying, “Zachary, put that on your bed”. Again, I very much encouraged parents to do the same thing to help ensure their child at least had an understanding of “his” or “her” name before moving on to pronouns – because pronouns, could be very, very confusing for a child with autism.

Zachary had long ago understood “his name” or “his label”. However, as I spoke to him, in the past, I had still limited my use of pronouns more than one normally would do in speech. That had not been true of others around him. Personally, I knew Zachary always seemed to have responded better when I just used “his name” – Zachary – instead of pronouns. I now understood fully why that was and it was this importance of pronouns I now hoped to help communicate to parents of other children with autism. Clearly, as Zachary’s understanding of pronouns increased, so did his speech. Of course, that made perfect sense given that it was difficult to speak if one was “confused” as to what to say in the first place. And pronoun confusion added to the confusion of speech and language, overall, if proper pronoun usage was not understood. It was indeed truly very, very difficult to speak without the use of pronouns. They were absolutely critical to speech and as such, it was absolutely critical they be understood.

I had been fortunate enough to understand that for Zachary to understand “his name” necessitated he understand that was “his label”. This was something we had been able to do rather early on and I had for a long time used “Zachary” instead of pronouns when referring to him. As I saw his understanding of language increase, I came to speak “more normally” thinking he would understand now since he understood so much better. Well, clearly, that was a mistake on my part and a mistake I was certain many other parents of children with autism had made. Zachary understood his name or “his label”, but he did not understand that there were other things that could take the place of his name or the place of other persons or things in language – something called pronouns – and he absolutely did not understand “how they worked”.

As my speech became more “normal” as I thought Zachary understood – key word being “thought” he understood – I began to use more and more pronouns with Zachary... and it was

only after the damage had been done that I realized he too suffered from “pronoun confusion”. His understanding of you, me, I, etc., was completely “mixed up”.

I soon realized why that was. Pronouns “flip flopped” based on who was doing the talking and who was doing the listening. Thus, unlike normal labels, they were “a moving target” so to speak – and as such, given I knew Zachary to live “via references” – these “moving targets” - if not understood – in my opinion, had implications that spanned far, far beyond “just speech” and extended well into the realm of the building or destroying of the “concept of self”.

In talking to Zachary, for so long, I had now used the pronoun “you” in addressing him or asking him questions. As such, it was no surprise that he thought “you” was simply another label for “Zachary”... he was close... but, he did not understand that “you” was not “pegged” to Zachary... it was what I came to call a “flipping pronoun”... because that was a concept he could understand. “Flipping” something was a concept that could be taught in a fairly concrete manner by showing Zachary the two sides to one thing. I could take a piece of paper, a CD, almost anything and show him how to “flip it” to the other side. As such, it was easy enough for Zachary to understand the concept of “flipping pronouns” – especially given I also used my hands to show him “the flipping” of pronouns as we spoke and practiced simple sentences like: “I love you and you love me”.

This simple phrase was an excellent one for teaching the three most critical pronouns we use in speech – I, you and me – three pronouns also very, very critical to the formation of the concept of self.

As we took turns saying this simple sentence, I would make sure I put my hand on my chest as I said: “I” and as I was saying the word “love”, my hand would be migrating to Zachary’s chest so that by the time I said “you”, my hand was on Zachary... leaving it there until I said “and you” and then moving it back to “me” so that it rested on my chest by the time I said “me”.

**The key to this exercise, however, was to then have Zachary do the same thing – where he now assumed the role of “I” and “me” and I became the “you”. To show Zachary the “flipping pronouns”, I absolutely had to do this step, otherwise, Zachary could very well think he was just “you” and that was his “other label” – the very message I did NOT want to give him.**

**Whenever we did “flipping pronoun games”, both persons had to take their turns in assuming the “I” and “me” role as well as the “you” role... all the while reinforcing that these were “flipping pronouns” by saying those very words. I would literally tell him: “You, me and I are flipping pronouns... they change based on whose talking”.**

There were many, many ways during the day that I could work on pronouns with Zachary. As he played, like any other parent, I often found myself asking him to do something. For example, I might say: “Zachary, please turn the tv off”, or, if he was doing something I did not want him to do, like spinning, I would say: “Zachary, stop spinning”. If he failed to listen right away, I would then say: “Zachary, what did I say?”.

Notice here... the last sentence was the critical one... “Zachary, what did I say?”. Before we started to work on pronouns, almost without a doubt he would answer something like: “I said stop spinning”. Note again, this was not the proper pronoun to use. Because “I” was doing the talking and labeled myself as “I”, he thought that this was the “label” to replace “mommy”. As such, if he responded this way: “I said stop spinning”... I would answer “not quite right... use flipping pronouns...and say... mommy, you said, stop spinning”. So, I would practice these simple exercises over and over with him until he started to get it on his own... whenever I asked him to do something and he failed to do it... I came back at him with a “what did I say” and made sure he responded “You said....” and not “I said...”. I also usually added the rule at the end of the dialogue and stated: “***When Zachary is talking, Zachary equals I or me and mommy equals you.... But, when mommy is talking, mommy equals I or me and Zachary equals you... you, me and I are flipping pronouns...***”.

***As tiring as it could be at times to ensure proper pronoun usage, I encouraged parents to always correct improper pronoun usage in their children, because, as I stated earlier, in my opinion, the implications of improper pronoun usage spanned far, far beyond “just language” and could very well extend into the realm of the building or destroying of the child’s concept of self – and “the self” in the child with autism was something that was very, very easily lost in the shuffle of “labels”.***

With a little practice, this was much easier than it seemed – and Zachary was finally “getting it”.

Given the importance of pronouns, this was the first topic I would cover in the next section – a section providing very practical exercises – as I do them – with Zachary. Just as there were many pieces to Zachary’s new K’NEX game and each piece had to fit in place perfectly to make the whole work properly, so too was it with the understanding of language.

I was my hope that these following pages could be of use to other parents in helping children with autism understand how the “parts” fit into the “whole” - in language - and how the child - the “I” - fit into the whole picture as well in order to help as many children as possible emerge from their shell to reveal the precious pearl hiding within. :o)

## **See Appendix For Actual Exercises On Building Sentences**



## End of Text

**This work, I give to you for the glory of  
my Lord and Savior, Jesus Christ.**

## Note to parents...

I encouraged all parents to go through these materials alone first in order to get a good understanding of the concepts and just an overall “feel” for what was provided in these pages prior to undertaking these exercises with your children. That way, if a child struggled with a particular section, perhaps you could spend more time on it using additional “blank bubbles” that were provided further in these pages before going on to another topic. “Knowing what you had available”, I believed, would better help you get through these materials and concepts. Any future additions to these materials would be posted along with these current materials under the [Parent Teaching Tools](#) link on my website: <http://www.autismhelpforyou.com>. There were several other materials already posted there for parents.

I also encouraged you to put your “concept sheets” in plastic cover sheets in a binder. These were actual sheets I used with Zachary in helping him to understand “how” language worked and were pages I was sure, parents would find themselves using, perhaps several times. Printing the same pages over and over again could get expensive rather fast, especially since many of these pages had a tremendous amount of color.

I chose to use a lot of color in these materials in order to help facilitate comprehension. However, parents who did not have a color printer or who chose to print in black and white for cost reasons would also be able to use these materials because, in addition to color variations, I was careful to include “shape variations”, too. I possible, however, ***did strongly encourage you to print these materials in color because I very much suspected color played a huge role in the world of children with autism.***

When building actual sentences, I chose to put in front of Zachary the “lists” provided herein... the list of pronouns, nouns, adjectives, verbs, adverbs, etc., to allow him to “pick words” from the appropriate lists as we worked on building sentences. This made things easier for Zachary and allowed us to focus on the task at hand with minimal stress. Minimizing stress in Zachary was always something I strived for in compiling materials for him because I wanted him to see learning as “fun” and the more stress, obviously, the less fun. Learning should be fun for all children – including children with autism. I urged all parents to resist the urge to “rush through” these materials. Teaching a concept a day was probably enough. Gauge ***your child – and yourself!*** When the learning ***or*** fun is gone, it is probably time to for a break or stop for the day.

***Note that I used “green ears” in my materials for listening. Originally, they had been “red”, however, I now knew some discipline programs used “red” and “green” “for acceptable or not” in behavior and as such, I did not want to confuse children or make them think that “red ears” = stop listening given “red” could be associated with “stop” in such programs. Subtle – but, again, potentially – critical!***

Finally, you may want to do a “search and replace” to change the name “Zachary” to your child’s name if you have a boy as that would make these exercises “more personal” for your child. If your child is a girl, that will be more difficult to do but you can do it and change the associated pronouns. It will just take a little more work. There are really not that many examples using “Zachary” and so, this is not a huge issue, but one I felt I should raise anyway for those parents who wanted to do that. I encouraged you to graph as many sentences as possible with your child once this concept was learned – from very basic to much more complicated sentences. :o)

Note: Some of these sheets/pages can be copied/printed over and over again and used to provide multiple examples of the same concept. Also, remember to use onomatopoeias and compound words as much as possible. :o)

# **PRONOUNS...**

**A pronoun is a word that takes the place of a noun.**

**A noun is a person, place or thing.**

**A pronoun provides a “shortcut” for talking...**

**A pronoun gives an “easier way” or “shorter way” to say something.**

# “FLIPPING PRONOUNS”...

**Some pronouns can only be used to “talk about people” or “take the place of someone’s name”.**

**The most important pronouns to understand are the flipping pronouns:**

**I**

**me**

**you**

**These are the “flipping pronouns”!**

# I, ME and YOU

## The “Flipping Pronouns”...

**I** and **Me** are pronouns used by the person who is **TALKING** to talk about “himself” or “herself” or “myself”.

**I = me = person talking**

**You** is a pronoun used by the person talking to talk to or talk about the “other person”.

So “YOU” is the person who is NOT talking.

**You = person listening =  
person NOT talking = other person**

**When people talk to one another, they  
“take turns” talking... first one person  
talks... then, the other person talks...**

**The person talking always = I or me**

**The other person always = you**

**That’s how “flipping pronouns” work...**

**They “flip flop” so...**

**The person talking always = I or me...**

**and...**

**The person listening always = you.**

person talking =  
person saying something =  
person with sounds coming  
from the mouth

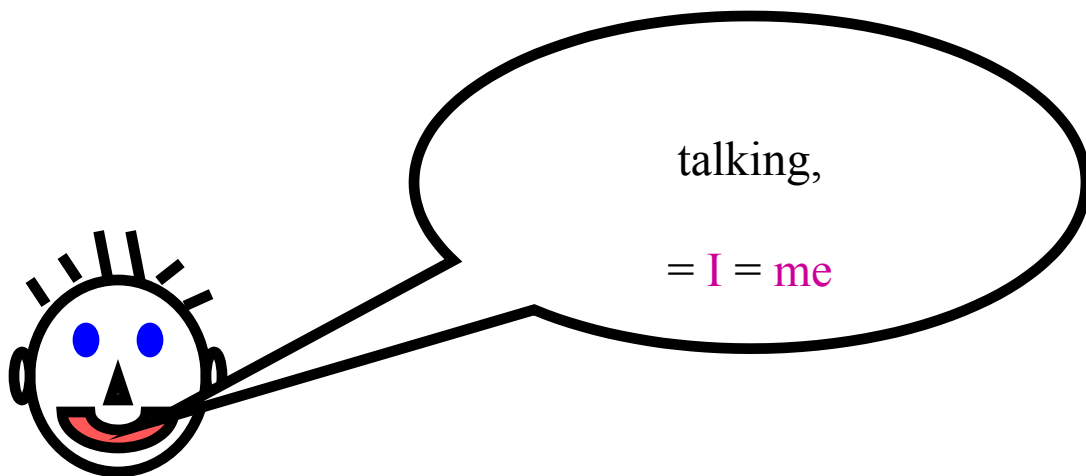

Person talking = **I or me**



# Person talking = I or me

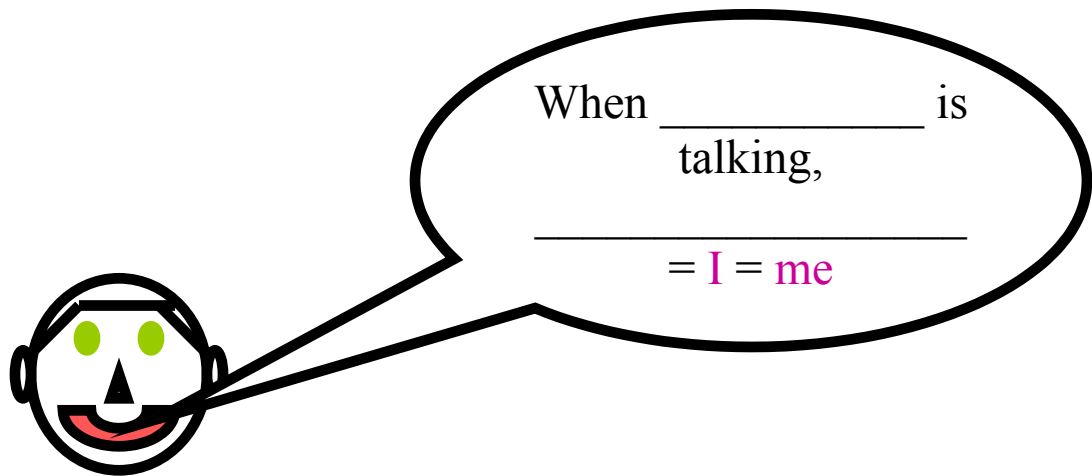

**person listening =**  
**person NOT talking =**  
**person with no sounds coming**  
**from the mouth =**  
**person hearing with ears**

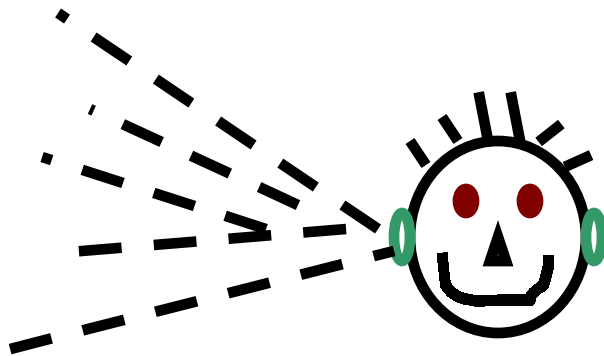

**person listening = you**

In a conversation, there is always **one person talking** and **one person listening...**

**person talking = I or me**

**person listening = you**



**person talking =**

**I = me**

**person listening =**

**you**

**When one person is all done talking,  
then the other person talks...**

**So, now, the new person talking**

**= I or me ...**

**and...**

**the new person listening = you...**

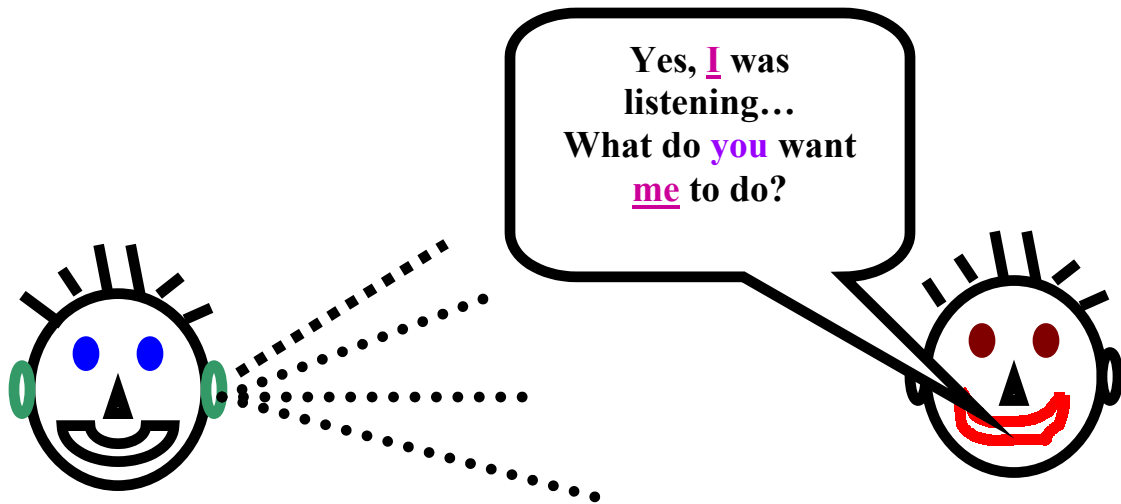

**new person  
listening = you**

**new person  
talking = I or me**

When the second person is done talking or asking a question, then the other person can talk again...

So, again, they “flip flop” or “switch” and so, the pronouns “I, me” and “you” “flip flop” too because the person talking and the person listening have changed – again...



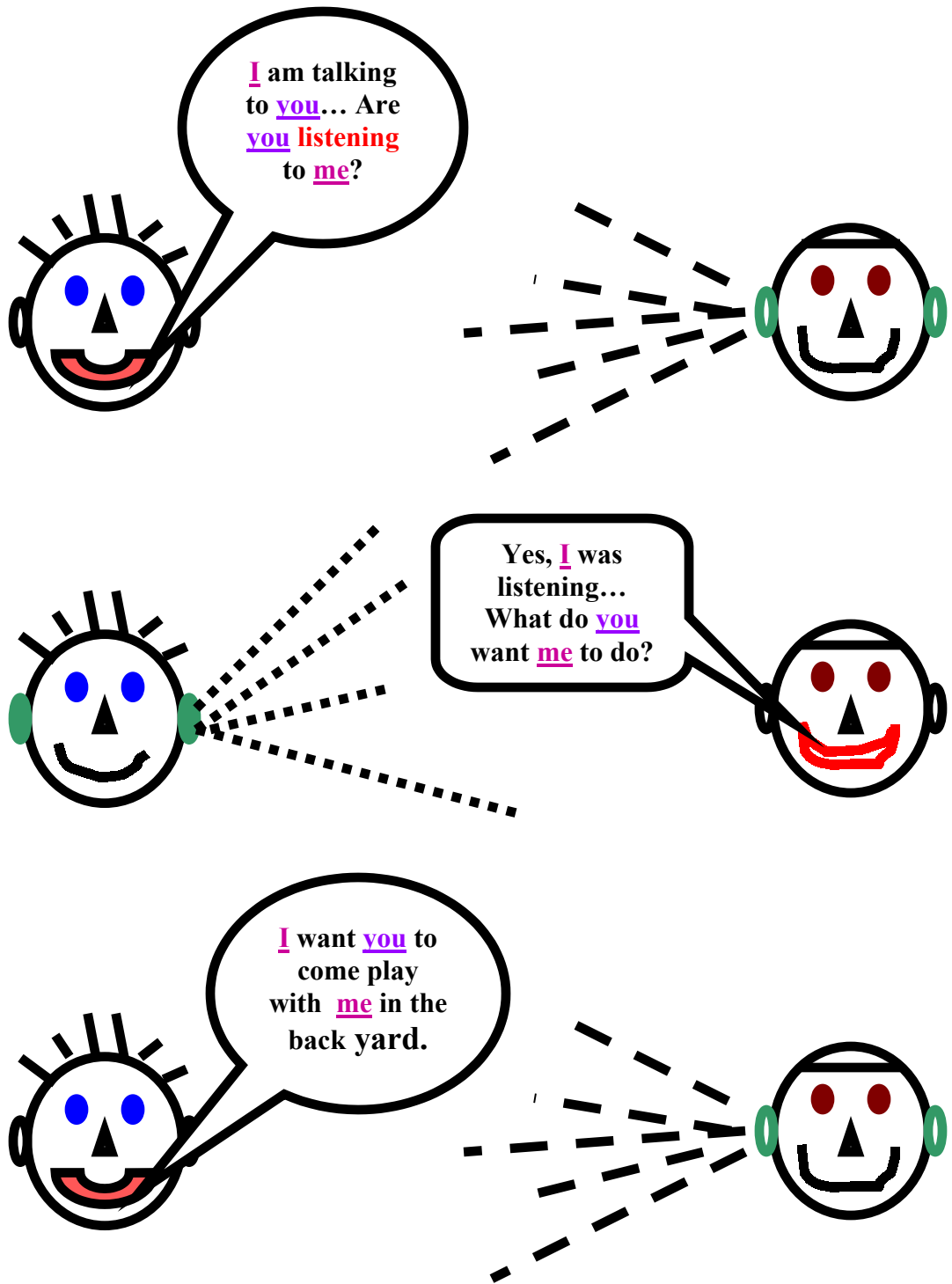

**Person talking = I or me**  
**Person listening = you**

# Person talking =

## I = me

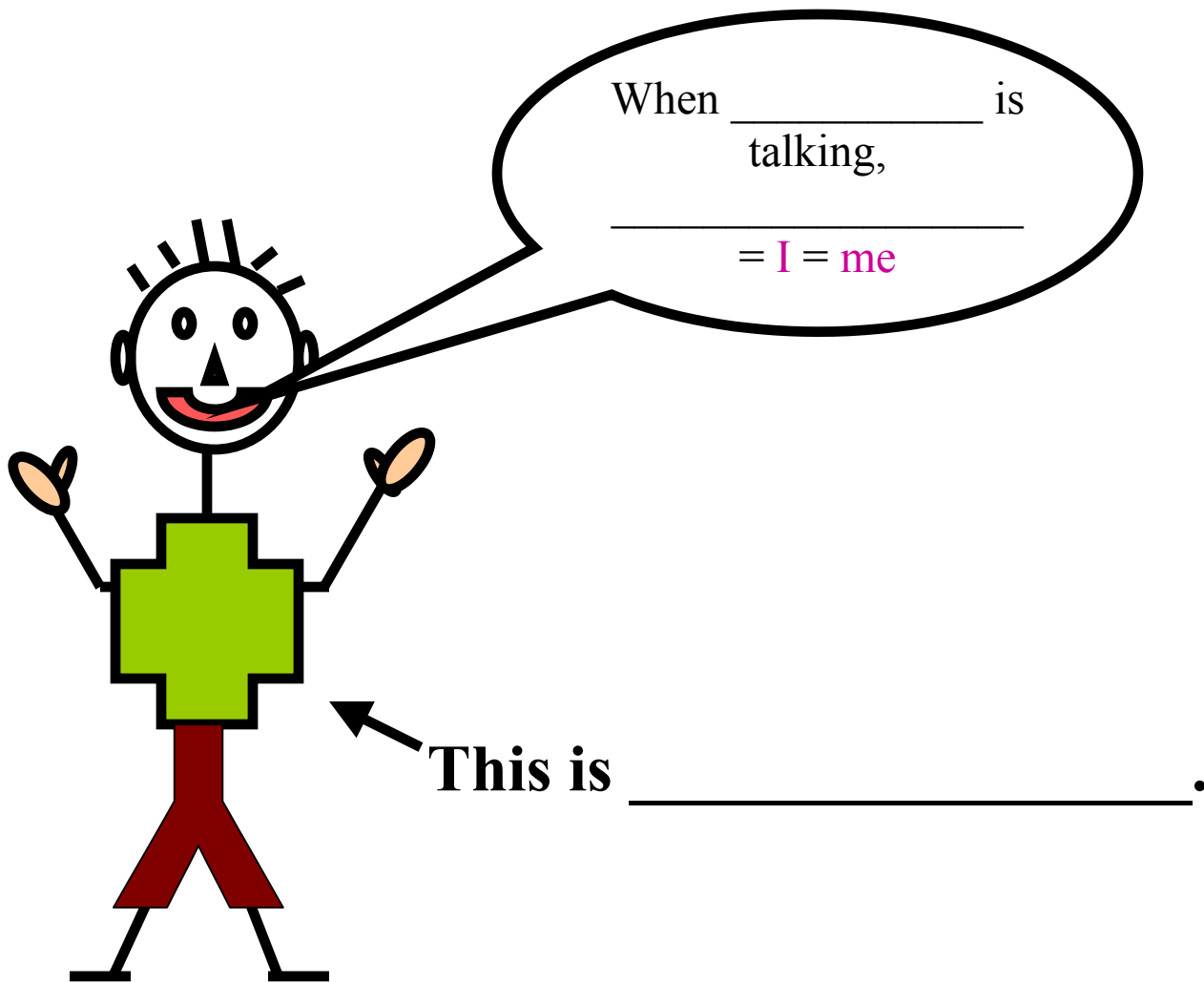

# Person talking =

## I = me

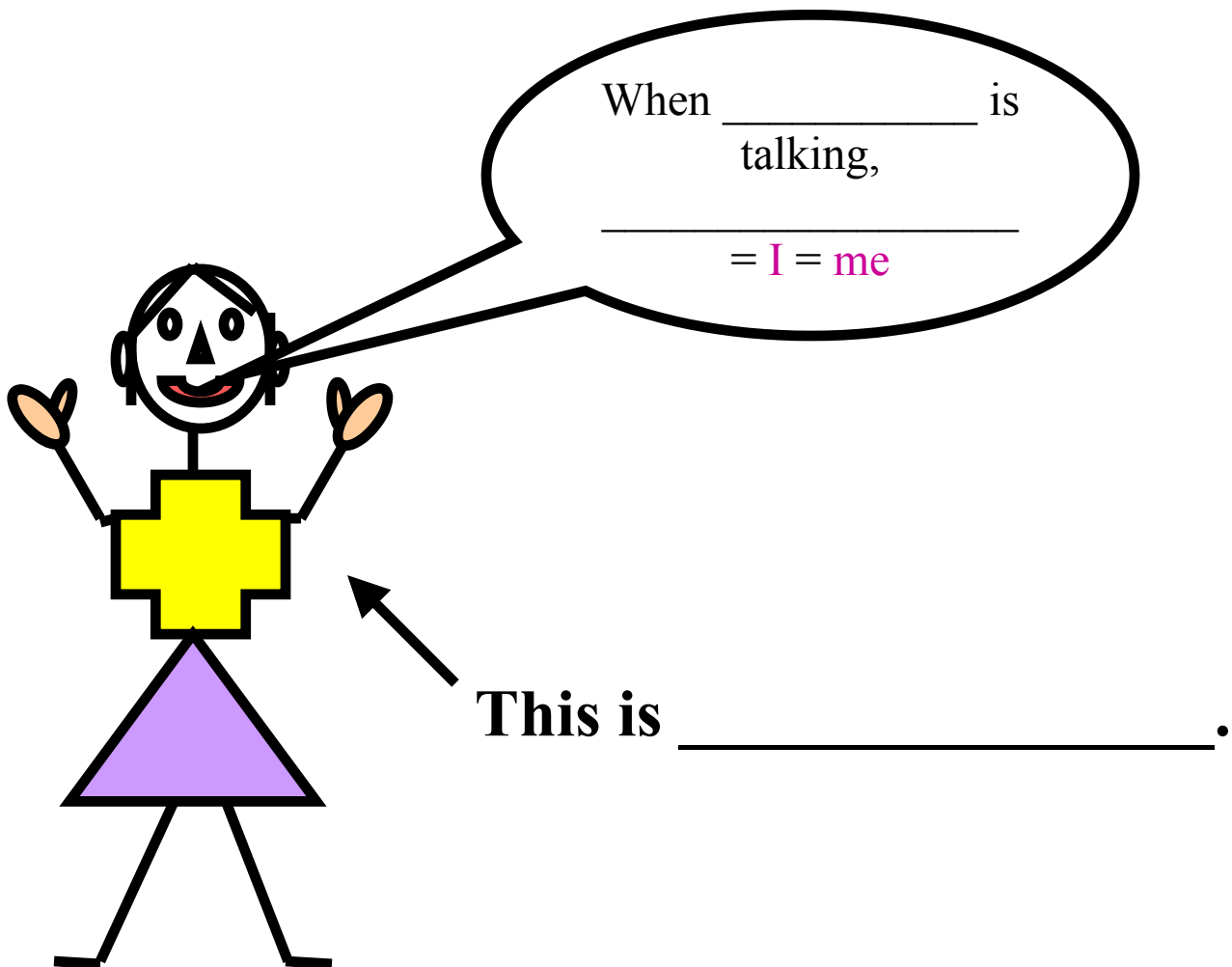



# Person talking =

## I = me

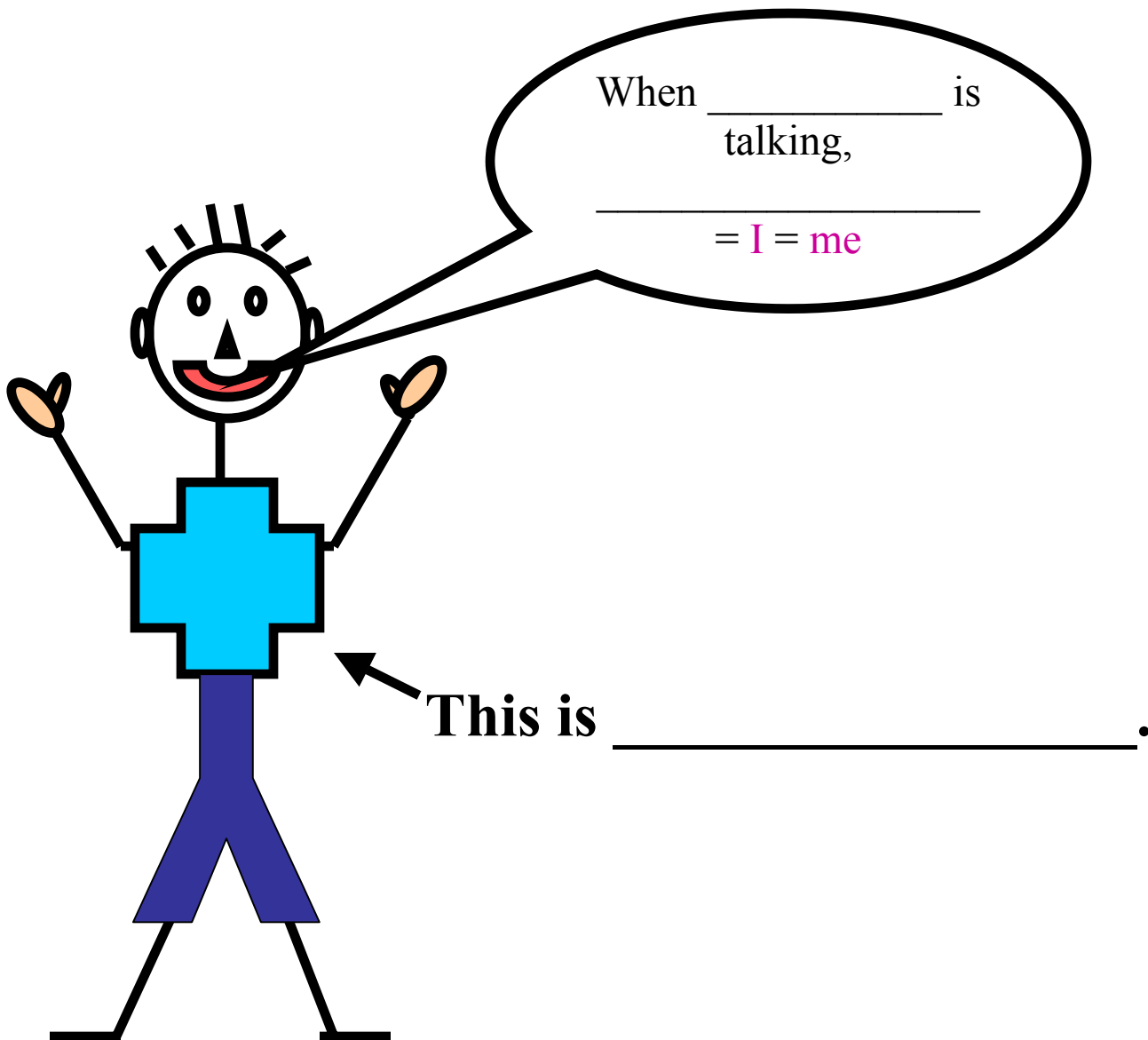

# Person talking =

## I = me

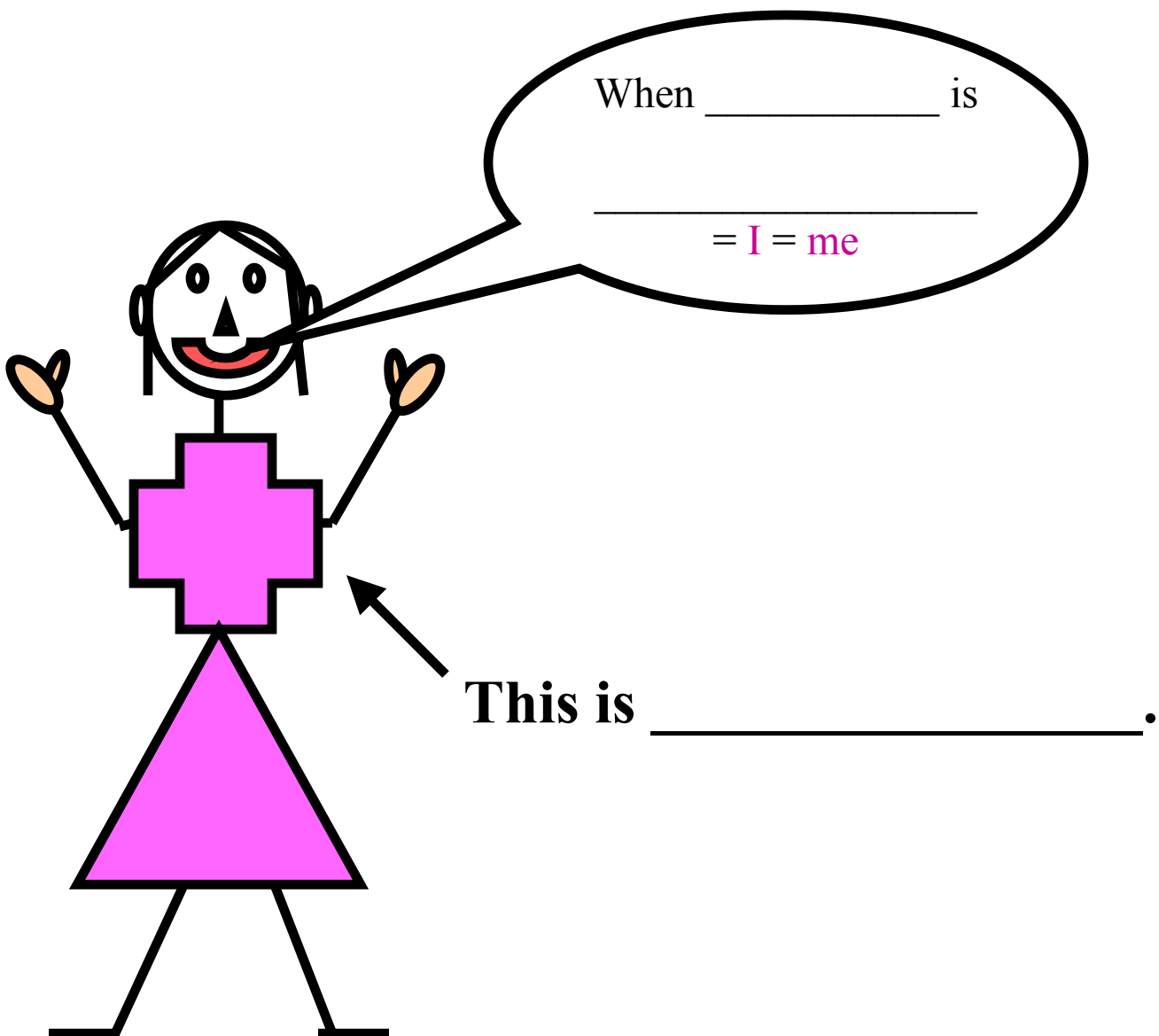

# Person listening = you

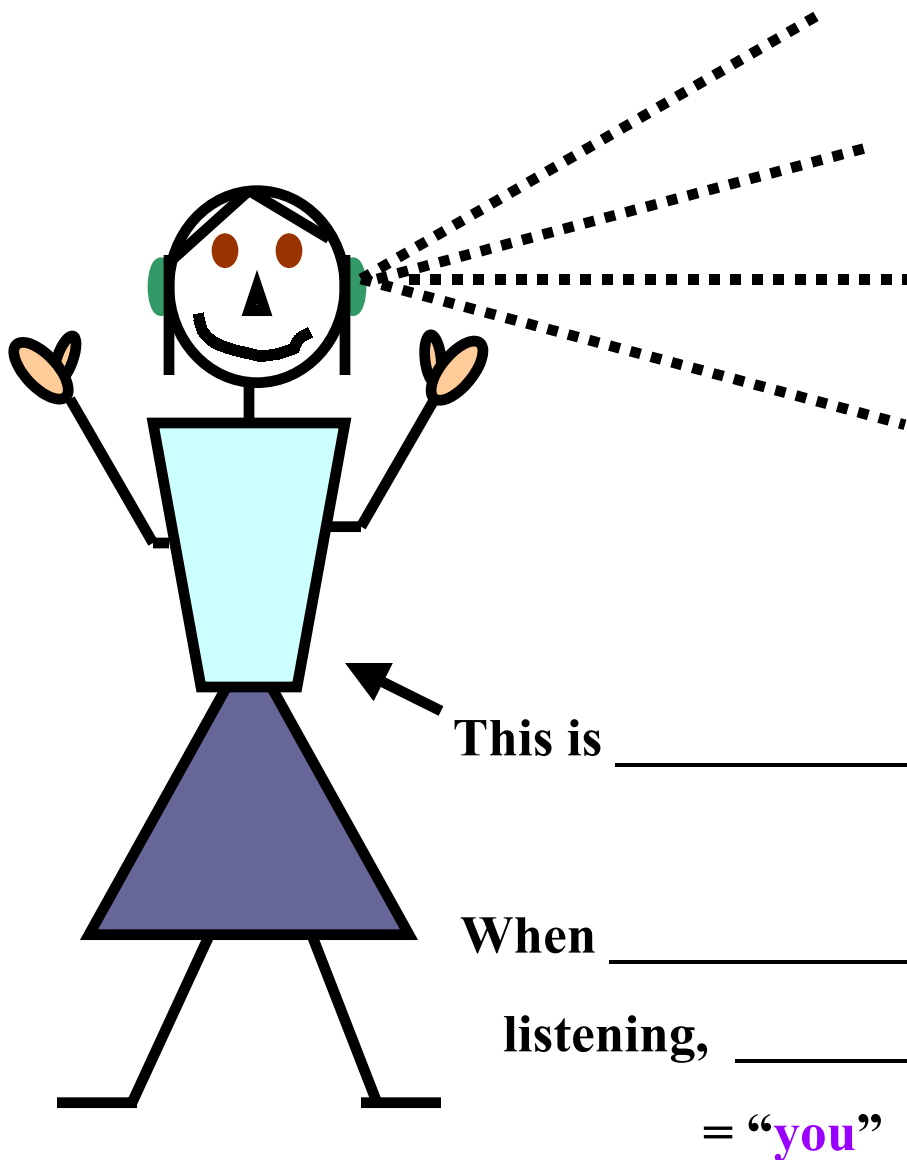

This is \_\_\_\_\_.

When \_\_\_\_\_ is

listening, \_\_\_\_\_ = you

**But...**

When \_\_\_\_\_ starts talking,

\_\_\_\_\_ = I = me.

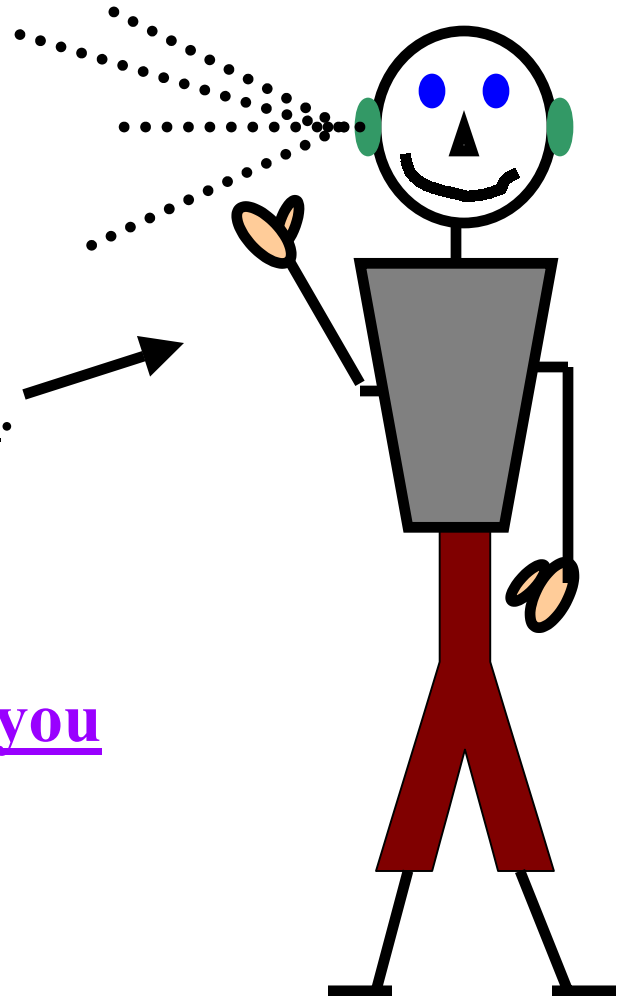

Some times, there is **more than one person listening to the one person talking...**

The **person talking** is still = **I** or **me**...

There can only be **one I** or **me** at one time because only one person can talk at one time...

But, there can be many people listening at one time, so...

All the people listening = you



**I, me**                      **and**                      **you**

## The “Flip Flopping” Pronouns...

**When** \_\_\_\_\_  
(my name)

**is talking to** \_\_\_\_\_  
(another person)

\_\_\_\_\_ = “**I**” or “**me**”  
(person talking)

**and** \_\_\_\_\_ = “**you**”.  
(the other person = person listening)

# I, me and you

## The “Flip Flopping” Pronouns...

When \_\_\_\_\_  
(name of new person talking)

is talking to \_\_\_\_\_  
(my name)

\_\_\_\_\_ = “I” or “me”  
(person talking)

and \_\_\_\_\_ = “you”.  
(the other person = person listening)

So, just like people “**take turns**” talking...

They also “take turns” being “**you**” or “**I**” or “**me**”...

**Person talking = I or me**

**Person listening = you**



**I = me**  
**= person talking**

**Some times, people talk to one  
another by writing words on  
paper for someone else to  
read, so...**

**I = me**  
**= person talking**  
**or person writing**

**There are many, many other pronouns or words to take the place of nouns.**

**Remember:**

**All pronouns are “shortcuts” or “easier ways to say something”...**

**The following are other pronouns people use when talking...**

# Pronouns...

my, mine, he, she, him, her, his, hers, your, yours, its,  
our, ours, their, theirs, who, whose, they, them, we,  
anybody, anyone, another, each, either, everybody,  
everyone, nobody, no one, neither, one, other,  
someone, somebody, many, both, few, several, others,  
all, any, some, none, this, that, those, these, who,  
whose, whom, which, what, whoever, whomever,  
whatever, whichever...

and don't forget...

I, me.... you...

are **pronouns**, too!

**Remember: Pronouns** are “shortcuts” people use  
when talking or writing... they take the place of the  
name of a **person**, **place** or **thing**...

Understanding **pronouns** is very important... so, we  
will look at them a little more...

# Pronouns...

Some pronouns “work together”...

<b>I</b>	=	<b>me</b>	=	<b>my/mine</b>
<b>you</b>	=	<b>you</b>	=	<b>your/yours</b>
<b>he</b>	=	<b>him</b>	=	<b>his</b>
<b>she</b>	=	<b>her</b>	=	<b>her, hers</b>
<b>it</b>	=	<b>it</b>	=	<b>its</b>
<b>we</b>	=	<b>us</b>	=	<b>our/ours</b>
<b>they</b>	=	<b>them</b>	=	<b>their/theirs</b>

<b>this/that</b>	=	<b>these/those</b>
------------------	---	--------------------

Here are a few examples of how to use  
pronouns...

**Zachary is happy.**

**That boy is happy.**

**He is happy.**

**boy = noun**

**he = pronoun = takes place of boy**

**The dog belongs to Zachary.**

**The dog belongs to the boy.**

**The dog is his.**

**It belongs to him.**

**his = pronoun = takes place of “the boy” and shows the dog belongs to “the boy”**

**it = pronoun = takes place of “the dog”**

**him = pronoun = takes the place of “the boy” and shows the dog belongs to “the boy”**

**I have a dog.**

**This is my dog.**

**This dog belongs to me.**

**This dog is mine.**

**I, me, my and mine are all pronouns used by the person talking to talk about something relating to “myself”.**

**I = me = my = mine**

**I**

**= person talking**

**= me**

**= my**

**= mine**

# You

= person(s) listening

**Remember:**

**There can be many people listening at once...**

**You = one person or many persons listening...**

you	=	you						
you	=	you	+	him				
you	=	you	+	her				
you	=	you	+	them				
you	=	you	+	he	+	she		
you	=	you	+	him	+	her		
you	=	you	+	you	+	you		
you	=	you	+	you	+	you	+	you
you	=	you	+	you	+	you	+	them

**You = one person listening**

**or**

**You = many persons listening**

**or**

**You = some persons listening**

**or**

**You = all persons listening**



**he**  
**= the boy**  
**= that boy**  
**= him**

**Remember:**

**Animals can be “boy animals” or “male animals”, too... so, “that boy” could be used to talk about a “male or boy dog” or a “male or boy horse” and so, people use “he” or “his” when talking about “boy or male animals”, too!**

**boy = male = he = him**

**she**  
**= the girl**  
**= that girl**  
**= her (s)**

**Remember:**

**Animals can be “girl animals” or “female animals”, too... so, “that girl” could be used to talk about a “female or girl dog” or a “female or girl horse” and so, people use “she” or “her” when talking about “girl or female animals”, too!**

**girl = female = she = her(s)**

# They... Them... Their(s)

= **almost** the same thing as  
 “you” ... **but not quite**...

Remember:

“You” could be only 1 person listening... or many persons listening or being talked about...

To use “**they**”, or “**their**” or “**them**” there **must be at least 2 or more** persons listening or being talked about...

They / them / their	=	him	+	her				
They / them / their	=	him	+	him				
They / them / their	=	her	+	her				
They / them / their	=	you	+	him				
They / them / their	=	you	+	her				
They / them / their	=	you	+	them				
They / them / their	=	you	+	he	+	she		
They / them / their	=	you	+	him	+	her		
They / them / their	=	you	+	you	+	you		
They / them / their	=	you	+	you	+	you	+	you
They / them / their	=	you	+	you	+	you	+	them

Note: “They” does **not** include I or me or my or mine...

“They” only takes about “other people” when there are 2 or more than 2 “other people”!

## Pronouns...

There are some pronouns that are used by the person talking or writing to talk about himself or herself, like...

**I, me, my, mine...**

And....

There are some pronouns that are used by the person talking or writing to talk about “other people”, like...

**you, he, she, him, her(s), they, them,  
their(s)...**

But...

There are also pronouns that are used to talk about both...

These are pronouns that put together

**I + you =**

**we, us, our(s)...**



## We...

The **girl** and **I** went to the store.

**She** and **I** went to the store.

**We** went to the store.

Rule: **We** = **she** + **I**

---

**He** and **she** and **I** are friends

**They** and **I** are friends.

Rule: **We** = **he** + **she** + **I**

**We** are friends.

Rule: **We** = **they** + **I**

---

**My mother**, **my sister** and **I** are eating.

**We** are eating.

Rule: **We** = **she** + **she** + **I**

Rule: **We** = **they** + **I**

---

## We always includes

## **Me or I + another person(s)!**

## Us...

Give it to **me** and **her**.

Give it to **us**.

Rule: **Us** = **me** + **her**

---

That belongs to **you**, **her**, and **me**.

That belongs to **you** and **me**.

Rule: **Us** = **you** + **her** + **me**

That belongs to **us**.

Rule: **Us** = **you** + **me**

---

It was **him** and **I** who did it.

It was **us** who did it.

Rule: **Us** = **him** + **I**

---

**Us** always includes

**Me or I + another person(s)!**

## Our(s)...

It is **her** cat and **mine**.

It is **our** cat.

Rule: **Our** = **mine** + **her(s)**

---

That house belongs to **you**, **her**, and **me**.

It is **our** house.

Rule: **Our(s)** = **you(s)** + **her(s)** + **me**

---

**His** book and **my** pencil were outside.

**Our** things were outside.

Rule: **Our** = **his** + **my**

---

It belongs to **you** and **I**.

It is **ours**.

Rule: **Ours** = **you(s)** + **mine**

---

**Our(s)** = **mine** + **someone else's**



**It(s)...**

**“It” is an easy pronoun to understand...**

**“It” takes the place of a thing or animal.**

**The table is brown.**

**It is brown.**

**The cat is sleeping.**

**It is sleeping.**

**The cat heard her kittens calling.**

**It heard its kittens calling.**

**There are many, many sentences you can make using pronouns...**

**The easiest way to understand how pronouns work is to listen to other people talking...**

**Once you know pronouns take the place of persons, places, and things, then, you just figure out what the pronoun is taking the place of...**

**Remember:**

**Be careful when it comes to “flipping pronouns”...**

**I = me = person talking**

**you = person listening**

**these are “tricky” because they change or “flip flop” with “whose talking”...**

**We (you + I) will do more on pronouns later...**

## Note To Parents...

To teach pronouns dealing with quantity, I used a favorite snack, such as gluten and casein free pretzels and showed Zachary the difference between “a few”, “some” “none”, “many”, “both”, “several”, etc.

This helped to provide a very concrete example for Zachary. These pronouns were not “flipping pronouns” and as such, the concept was much more easily grasped via a simple exercise as provided above.

In working with these pronouns, I also made sure all of Zachary’s pronoun usage was correct... if not, I would correct him by literally telling him what to say. For example, if I said, “how many do you want?” ... I made sure he responded with “I want ....” as opposed to just saying the one word such as “many”... he had to include the “I want...” in his request. If he said something like: “give you three...”... I replied: “Say... Give me three...”. I literally told Zachary what to say by using the word... “Say...” to show him the appropriate response.

Proper pronoun usage was absolutely critical to the development of language skills and I believed the inability to “figure out” how pronouns work may be one of the many reasons children with autism were so delayed in their speech. The reason for that will be clearly evident as parents proceed through these materials. With better understanding of pronouns, there is no denying that Zachary’s speech was flourishing.

Interestingly, I noticed on a walk recently that when Zachary did not know what pronoun to use, he simply left it out of his sentence and said: “Anika, where are ... going?” He had left out the “you”... I corrected him and gave him the proper sentence by saying: “You say... Anika, where are you going?”

Of all the pronouns, without a doubt, “I, me and you” were the most difficult for Zachary to grasp and required the most work...

Until a child understood how speech worked, how could he use speech in the form of sentences/conversation? Pronouns, as you shall see, were absolutely critical in speech and quite frankly, it was only when I started to “graph them”, that I realized ***how*** critical understanding them truly was – as you, too, shall soon see for yourself – and when you do see that – you will understand why it is so hard for these children to understand how pronouns work. It would indeed be very difficult to figure it out, “on their own”, especially, since at least initially, children with autism, very much appear to “live via reference”... and if the references were “moving targets”, communication, and life overall, became difficult indeed!

As such, I strongly urged all parents to ensure proper pronoun usage by always correcting improper pronouns used by a child with autism and explaining the “why” for the correct usage by providing “a rule” as provided in these materials (i.e., “When Zachary is talking, Zachary = I = me = my = mine”, etc.).

More on pronouns later...

## **Note to parents...**

**Obviously, for a child to understand the “flipping pronouns” concept, he has to have an understanding of “taking turns”... this was a simple enough concept to teach via playing with a ball or using the “I love you and you love me” sentence and saying... “now your turn to say it...”**

**Understanding the concept of “taking turns” was thus critical to the understanding of proper pronoun usage for “flipping pronouns”...**

## **Note to parents...**

**Time and time again, I had noticed that Zachary absolutely loved to do anything with colors, motion and sounds.**

**As such, I try to build sentences with Zachary that would include these things. Action verbs provide for the alluding to motion, but, where possible, I also tried to “act out” the motion as we work on language skills.**

**Colors were easily enough incorporated or alluded to. Just drawing his attention to the various colored parts of the “sentence train” or using different colored pencils or “color adjectives” was enough to keep Zachary interested in the task at hand.**

**I also tried to use sound as much as possible... Zachary loved onomatopoeias... these were words that sounded very much like their actual spelling. I provided a list of these on the following page. I knew that Zachary loved any sentence that included these ... he got very excited when I really emphasized the sound and/or acted it out.**

**I encouraged parents to make use of these words in “building sentences” also. :o)**

## Onomatopoeias...

<b>ahhh</b>	<b>croak</b>	<b>ooph</b>	<b>splat</b>
<b>arf-arf</b>	<b>cuckoo</b>	<b>ouch</b>	<b>splutter</b>
<b>atchoom</b>	<b>ding-dong</b>	<b>paf</b>	<b>squeak</b>
<b>baa</b>	<b>drip</b>	<b>peek-a-boo</b>	<b>squish</b>
<b>bang</b>	<b>eeek</b>	<b>pitter-patter</b>	<b>swish</b>
<b>bark</b>	<b>fizz</b>	<b>plop</b>	<b>swoosh</b>
<b>beep-beep</b>	<b>flush</b>	<b>poof</b>	<b>tap</b>
<b>blink</b>	<b>growl</b>	<b>pop</b>	<b>thump</b>
<b>bloop</b>	<b>grrrr</b>	<b>pow</b>	<b>tick</b>
<b>blop</b>	<b>gulp</b>	<b>purr</b>	<b>tick-tock</b>
<b>bong</b>	<b>gurgle</b>	<b>quack</b>	<b>tinkle</b>
<b>boo-hoo-hoo</b>	<b>ha-ha</b>	<b>ribbit-ribbit</b>	<b>twang</b>
<b>boom</b>	<b>he-haw</b>	<b>ring-a-ding-ding</b>	<b>tweet-tweet</b>
<b>bow-wow</b>	<b>he-he</b>	<b>ring-ring</b>	<b>uh-oh</b>
<b>brrrr</b>	<b>hiccup</b>	<b>rip</b>	<b>ummm</b>
<b>bump</b>	<b>hiss</b>	<b>roar</b>	<b>vroom</b>
<b>buzz</b>	<b>hmmm</b>	<b>rock</b>	<b>wah</b>
<b>chirp</b>	<b>ho-ho</b>	<b>ruff-ruff</b>	<b>wham</b>
<b>chomp</b>	<b>honk</b>	<b>rustle</b>	<b>wheeze</b>
<b>choo-choo</b>	<b>hoot</b>	<b>scratch</b>	<b>whir</b>
<b>clap</b>	<b>hooray</b>	<b>screech</b>	<b>whisper</b>
<b>click</b>	<b>hush</b>	<b>shhhh</b>	<b>whoa</b>
<b>click-clack</b>	<b>kaboom</b>	<b>shush</b>	<b>whoosh</b>
<b>cling-clang</b>	<b>la-de-da</b>	<b>sizzle</b>	<b>woof</b>
<b>clip-clop</b>	<b>maa</b>	<b>slam</b>	<b>wow</b>
<b>clop</b>	<b>meow</b>	<b>slurp</b>	<b>yahoo</b>
<b>cluck</b>	<b>moan</b>	<b>smash</b>	<b>yee-haw</b>
<b>cock-a-doodle-doo</b>	<b>moo</b>	<b>snap</b>	<b>yikes</b>
<b>crack</b>	<b>mumble</b>	<b>sniff</b>	<b>yippee</b>
<b>crackle</b>	<b>murmur</b>	<b>sniffle</b>	<b>zip</b>
<b>crash</b>	<b>neigh</b>	<b>spatter</b>	<b>zoom</b>
<b>creak</b>	<b>oink-oink</b>	<b>splash</b>	
<b>crunch</b>	<b>oops</b>	<b>splosh</b>	

## Opposites...

all	none
awake	asleep
big	small
black	white
city	country
clean	dirty
day	night
earth	sky
empty	full
fast	slow
first	last
fixed	broken
forward	backward
front	back
girl	boy
go	stop
good	bad
happy	sad
high	low
hot	cold
in	out
inside	outside
left	right
light	dark
light	heavy
morning	night
near	far
on	off
open	close
over	under
push	pull
quiet	loud
smooth	rough
soft	hard
stand	sit
start	finish
straight	crooked
sun	moon
sunny	rainy
sweet	sour
tall	short
top	bottom
up	down
wet	dry

# Compound Words

back	+	yard	=	backyard
bath	+	room	=	bathroom
bath	+	tub	=	bathtub
birth	+	day	=	birthday
book	+	mark	=	bookmark
book	+	case	=	bookcase
book	+	keeper	=	bookkeeper
bottle	+	neck	=	bottleneck
car	+	pool	=	carpool
day	+	light	=	daylight
dog	+	house	=	doghouse
down	+	town	=	downtown
ear	+	ring	=	earring
earth	+	quake	=	earthquake
every	+	day	=	everyday
finger	+	print	=	fingerprint
fire	+	man	=	fireman
fire	+	place	=	fireplace
foot	+	print	=	footprint
foot	+	ball	=	football
gold	+	fish	=	goldfish
grass	+	hopper	=	grasshopper
hair	+	clip	=	hairclip
hill	+	top	=	hilltop
house	+	boat	=	houseboat
in	+	side	=	inside
key	+	chain	=	keychain
light	+	house	=	lighthouse
lip	+	stick	=	lipstick
mail	+	man	=	mailman

mail	+	box	=	mailbox
mouse	+	trap	=	mousetrap
my	+	self	=	myself
news	+	paper	=	newspaper
night	+	light	=	nightlight
oat	+	meal	=	oatmeal
out	+	side	=	outside
over	+	all	=	overall
pea	+	nut	=	peanut
pitch	+	fork	=	pitchfork
police	+	man	=	policeman
pop	+	corn	=	popcorn
quick	+	sand	=	quicksand
rail	+	road	=	railroad
sail	+	boat	=	sailboat
sand	+	bar	=	sandbar
sauce	+	pan	=	saucepan
seat	+	belt	=	seatbelt
snow	+	flake	=	snowflake
some	+	day	=	someday
some	+	where	=	somewhere
some	+	time	=	sometime
some	+	body	=	somebody
sun	+	light	=	sunlight
tooth	+	paste	=	toothpaste
trash	+	can	=	trashcan
under	+	ground	=	underground
wall	+	paper	=	wallpaper
water	+	fall	=	waterfall
your	+	self	=	yourself



**People use “sentences” when they talk.**

**A sentence is made by putting together different kinds of words in a way that “makes sense”.**

**There are many different kinds of words.**

**Nouns, pronouns, adjectives, articles, verbs, adverbs,  
conjunctions, prepositions**

**There are also different kinds of sentences.**

**There are many different kinds of words in a sentence.**

**Making a sentence is like building a train...**

**I just put parts together...**

**and the parts can sometimes move around...**

**but, they always have to make sense!**

**Make sense = not silly**

**Silly = makes no sense**

**Example: The house is running.**

**That is a “silly sentence” because a house can not run.**

**We do not use silly sentences when we talk.**

**We only use sentences that make sense.**

**To start building a sentence train, I have to know all the parts available and then try to put them together so they make sense and are “not silly”.**

### **Sentence Parts:**

**nouns, pronouns, adjectives, articles, verbs, adverbs,  
conjunctions, prepositions**

**Some sentences have lots of parts...**

**Some sentences only have one or two parts...**

**Building a sentence train will help me understand how  
a sentence works...**

**A train has different parts...  
and each part has a specific function or purpose.**

**A function is what something does.**

**A train can have lots of parts.  
Each part has a specific function.**

**For example, a train engine pulls the train.**

**“the part” = the engine**

**“the function” of the engine = pull the train.**

**The train engine “is doing something”.**

A sentence can have lots of parts too...

And each sentence part also has a specific function.

A sentence has “an engine” too...

it is called a “verb”

sentence engine = a verb

The verb is the part of the sentence that  
“does something”.

Now, we need to build a sentence train.

a verb = the sentence engine = does something

We’ll put our sentence engine in a square...



verb = sentence engine

## The Verb...



**verb = sentence engine**

**Although sentences usually have lots of words, some sentences only have one word.**

**The one word all sentences must have is...**

**a verb**

**A train needs an engine to do something.  
Sometimes, we see just the train engine going  
down the track.**

**A verb is like a train engine... it can work kind of  
by itself or have lots of other parts tied to it.**

## Interjections...

**There are special words called “interjections” that can also be one word sentences in and of themselves...**

**These would include things like:**

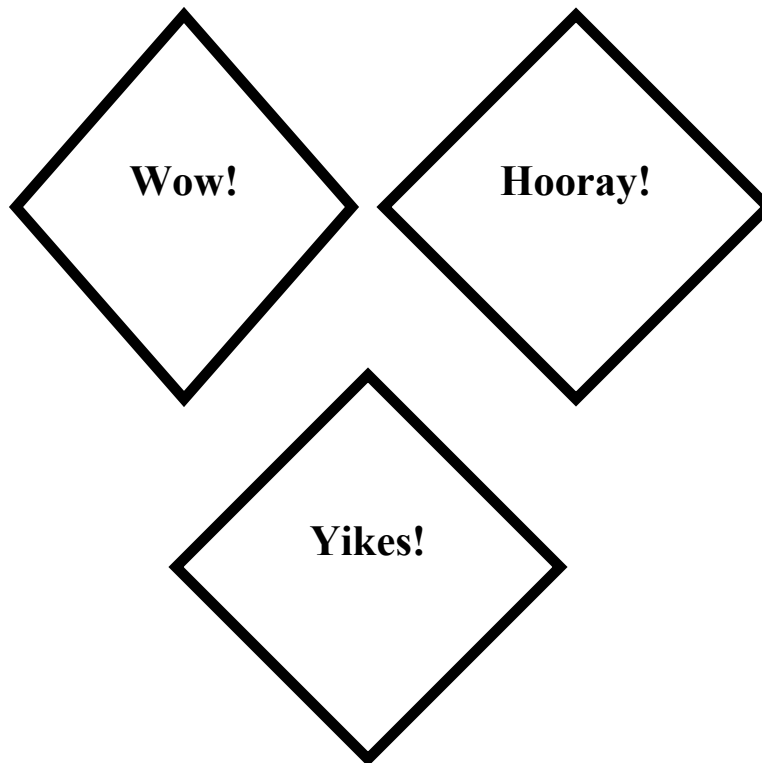

**There are many different kinds of train engines.**

**There are steam engines, oil engines, coal engines,  
electric engines, etc.**

**There are also many, many sentence engines – or  
verbs I can use in a sentence train.**

**The following few pages have lots of sentence  
engines to choose from to build a sentence train.**

**Remember: A sentence train needs at least one  
engine – or verb – to work!**

**These are only a few of the sentence engines - verbs  
– I can use.**

**There are many other verbs I could also use.**

**Remember: a sentence engine = a verb**

**A verb = an action word = doing something**



## **Note To Parents...**

**In working with verb tenses, it was important to be very careful about the wording of sentences in order not to confuse a child.**

**For example, although the words “now, yesterday, and tomorrow” were great helpers in determining present, past and future tenses, a poorly worded phrase could easily cause confusion. Take the following examples:**

**Now, I will go to the store.**

**In this example, the verb is future tense although it was used with the word “now”.**

**A better sentence to teach “present” using “now” would be:  
Now, I am going to the store.**

**Some people like to use the word “today” for present... in my opinion, that can be even more confusing. Look at the following examples:**

**Today, I went to the store. (past)**

**Today, I am going to the store. (present)**

**Today, I will be going to the store. (future)**

**All three sentences “are valid” and grammatically correct... but only one teaches the “present” using the verb “am going”. As such, parents need to be extremely careful to make sure that the “helping word” (i.e., now, today, yesterday, tomorrow) is one that absolutely matches the verb tense or else, confusion will surely reign.**

# Verb Tense

**a sentence engine = a verb**

**a verb = an action word =**

**what's happening and when**

An “**action**” can be something...

being done now = still doing it = PRESENT tense

already finished = already done = PAST tense

not started yet = done later on = FUTURE tense

# Verb Tenses...

**Now = PRESENT**

**Finished = PAST**

**Not Started Yet = FUTURE**

**Action words = verbs**  
**= what's happening and when**

**Verbs can change based on present, past or future**

**I am swimming in a cold lake. = PRESENT = doing it now**

**I swam in a cold lake. = PAST = all done**

**I will swim in a cold lake. = FUTURE = not started yet**

Some words can help me to figure out the correct **verb tense** if I put them first in the sentence.

If I use the word **NOW**, that helps me figure out the **PRESENT** verb tense.

If I use the word **YESTERDAY**, that helps me figure out the **PAST** verb tense.

If I use the word **TOMORROW**, that helps me figure out the **FUTURE** verb tense.

**Now = Present**

**All done = Past**

**Not started yet = Future**

**Verb = Action word = What's happening and when**

**I need to ask myself:**

**“When does the action take place”?**

**Is it now, or something already done, or something to be done later?**

**NOW = doing it now = PRESENT verb tense**

**YESTERDAY = already done = PAST verb tense**

**TOMORROW = doing it later = not started yet = FUTURE tense**

## Verb Tense...

Now, I am swimming in a cold lake. = PRESENT = now

Yesterday, I swam in a cold lake. = PAST = all done

Tomorrow, I will swim in a cold lake. = FUTURE = not started yet

**Now = Present**

**All done = Past**

**Not started yet = Future**



## Verb Tense = Present, Past or Future

**There are other verb tenses, too... I can learn those  
when I get older...**

**When is the action (verb) happening ?**

<b>Verb</b>	<b>Present =  doing it now</b>	<b>Present Participle =  Incomplete action = continuous form of the verb</b>	<b>Past =  all done =  finished doing it</b>	<b>Future =  not started yet =  doing it soon or later on  Note: With pronouns “<u>I</u>” and “<u>we</u>”, you can also use “<u>shall</u>” instead of “<u>will</u>”</b>
<b>to bake</b>	<b>bake(s)</b>	<b>baking</b>	<b>baked</b>	<b>will bake</b>
<b>to be</b>	<b>is, am, are,</b>	<b>being</b>	<b>was, were</b>	<b>will be</b>
<b>to beat</b>	<b>beat(s)</b>	<b>beating</b>	<b>beat</b>	<b>will beat</b>
<b>to begin</b>	<b>begin(s)</b>	<b>beginning</b>	<b>began</b>	<b>will begin</b>
<b>to bite</b>	<b>bite(s)</b>	<b>biting</b>	<b>bit</b>	<b>will bite</b>
<b>to blow</b>	<b>blow(s)</b>	<b>blowing</b>	<b>blew</b>	<b>will blow</b>
<b>to bounce</b>	<b>bounce(s)</b>	<b>bouncing</b>	<b>bounced</b>	<b>will bounce</b>
<b>to break</b>	<b>break(s)</b>	<b>breaking</b>	<b>broke</b>	<b>will break</b>
<b>to bring</b>	<b>bring(s)</b>	<b>bringing</b>	<b>brought</b>	<b>will bring</b>
<b>to brush</b>	<b>brush(es)</b>	<b>brushing</b>	<b>brushed</b>	<b>will brush</b>
<b>to build</b>	<b>build(s)</b>	<b>building</b>	<b>built</b>	<b>will build</b>
<b>to burst</b>	<b>burst(s)</b>	<b>bursting</b>	<b>burst</b>	<b>will burst</b>

<b>Verb</b>	<b>Present =  doing it now</b>	<b>Present Participle =  Incomplete action = continuous form of the verb</b>	<b>Past =  all done =  finished doing it</b>	<b>Future =  not started yet =  doing it soon or later on  Note: With pronouns "<u>I</u>" and "<u>we</u>", you can also use "<u>shall</u>" instead of "will"</b>
<b>to buy</b>	<b>buy(s)</b>	<b>buying</b>	<b>bought</b>	<b>will buy</b>
<b>to carry</b>	<b>carry, carries</b>	<b>carrying</b>	<b>carried</b>	<b>will carry</b>
<b>to catch</b>	<b>catch, catches</b>	<b>catching</b>	<b>caught</b>	<b>will catch</b>
<b>to clap</b>	<b>clap(s)</b>	<b>clapping</b>	<b>clapped</b>	<b>will clap</b>
<b>to clean</b>	<b>clean(s)</b>	<b>cleaning</b>	<b>cleaned</b>	<b>will clean</b>
<b>to climb</b>	<b>climb(s)</b>	<b>climbing</b>	<b>climbed</b>	<b>will climb</b>
<b>to close</b>	<b>close(s)</b>	<b>closing</b>	<b>closed</b>	<b>will close</b>
<b>to color</b>	<b>color(s)</b>	<b>coloring</b>	<b>colored</b>	<b>will color</b>
<b>to comb</b>	<b>comb(s)</b>	<b>combing</b>	<b>combed</b>	<b>will comb</b>
<b>to come</b>	<b>come(s)</b>	<b>coming</b>	<b>came</b>	<b>will come</b>
<b>to cook</b>	<b>cook(s)</b>	<b>cooking</b>	<b>cooked</b>	<b>will cook</b>
<b>to crawl</b>	<b>crawl(s)</b>	<b>crawling</b>	<b>crawled</b>	<b>will crawl</b>
<b>to cry</b>	<b>cry, cries</b>	<b>crying</b>	<b>cried</b>	<b>will cry</b>
<b>to cut</b>	<b>cut(s)</b>	<b>cutting</b>	<b>cut</b>	<b>will cut</b>
<b>to dance</b>	<b>dance(s)</b>	<b>dancing</b>	<b>danced</b>	<b>will dance</b>
<b>to dig</b>	<b>dig(s)</b>	<b>digging</b>	<b>dug</b>	<b>will dig</b>
<b>to dive</b>	<b>dive(s)</b>	<b>diving</b>	<b>dived, dove</b>	<b>will dive</b>
<b>to do</b>	<b>do, does</b>	<b>doing</b>	<b>did</b>	<b>will do</b>
<b>to draw</b>	<b>draw(s)</b>	<b>drawing</b>	<b>drew</b>	<b>will draw</b>

<b>Verb</b>	<b>Present =  doing it now</b>	<b>Present Participle =  Incomplete action = continuous form of the verb</b>	<b>Past =  all done =  finished doing it</b>	<b>Future =  not started yet =  doing it soon or later on  Note: With pronouns “<u>I</u>” and “<u>we</u>”, you can also use “<u>shall</u>” instead of “will”</b>
<b>to dream</b>	<b>dream(s)</b>	<b>dreaming</b>	<b>dreamed</b>	<b>will dream</b>
<b>to drink</b>	<b>drink(s)</b>	<b>drinking</b>	<b>drank</b>	<b>will drink</b>
<b>to drive</b>	<b>drive(s)</b>	<b>driving</b>	<b>drove</b>	<b>will drive</b>
<b>to eat</b>	<b>eat(s)</b>	<b>eating</b>	<b>ate</b>	<b>will eat</b>
<b>to fall</b>	<b>fall(s)</b>	<b>falling</b>	<b>fell</b>	<b>will fall</b>
<b>to feel</b>	<b>feel(s)</b>	<b>feeling</b>	<b>felt</b>	<b>will feel</b>
<b>to float</b>	<b>float(s)</b>	<b>floating</b>	<b>floated</b>	<b>will float</b>
<b>to fly</b>	<b>fly, flies</b>	<b>flying</b>	<b>flew</b>	<b>will fly</b>
<b>to fold</b>	<b>fold(s)</b>	<b>folding</b>	<b>folded</b>	<b>will fold</b>
<b>to freeze</b>	<b>freeze(s)</b>	<b>freezing</b>	<b>froze</b>	<b>will freeze</b>
<b>to give</b>	<b>give(s)</b>	<b>giving</b>	<b>gave</b>	<b>will give</b>
<b>to glue</b>	<b>glue(s)</b>	<b>gluing</b>	<b>glued</b>	<b>will glue</b>
<b>to go</b>	<b>go, goes</b>	<b>going</b>	<b>went</b>	<b>will go</b>
<b>to grow</b>	<b>grow(s)</b>	<b>growing</b>	<b>grew</b>	<b>will grow</b>
<b>to have</b>	<b>has, have</b>	<b>having</b>	<b>had</b>	<b>will have</b>
<b>to hear</b>	<b>hear(s)</b>	<b>hearing</b>	<b>heard</b>	<b>will hear</b>
<b>to hit</b>	<b>hit(s)</b>	<b>hitting</b>	<b>hit</b>	<b>will hit</b>
<b>to hop</b>	<b>hop(s)</b>	<b>hopping</b>	<b>hopped</b>	<b>will hop</b>
<b>to hope</b>	<b>hope(s)</b>	<b>hoping</b>	<b>hoped</b>	<b>will hope</b>

<b>Verb</b>	<b>Present =  doing it now</b>	<b>Present Participle =  Incomplete action = continuous form of the verb</b>	<b>Past =  all done =  finished doing it</b>	<b>Future =  not started yet =  doing it soon or later on  Note: With pronouns “<u>I</u>” and “<u>we</u>”, you can also use “<u>shall</u>” instead of “will”</b>
<b>to hurt</b>	<b>hurt(s)</b>	<b>hurting</b>	<b>hurt</b>	<b>will hurt</b>
<b>to iron</b>	<b>iron(s)</b>	<b>ironing</b>	<b>ironed</b>	<b>will iron</b>
<b>to juggle</b>	<b>juggle(s)</b>	<b>juggling</b>	<b>juggled</b>	<b>will juggle</b>
<b>to jump</b>	<b>jump(s)</b>	<b>jumping</b>	<b>jumped</b>	<b>will jump</b>
<b>to kick</b>	<b>kick(s)</b>	<b>kicking</b>	<b>kicked</b>	<b>will kick</b>
<b>to knit</b>	<b>knit(s)</b>	<b>knitting</b>	<b>knitted</b>	<b>will knit</b>
<b>to knock</b>	<b>knock(s)</b>	<b>knocking</b>	<b>knocked</b>	<b>will knock</b>
<b>to know</b>	<b>know(s)</b>	<b>knowing</b>	<b>knew</b>	<b>will know</b>
<b>to laugh</b>	<b>laugh(s)</b>	<b>laughing</b>	<b>laughed</b>	<b>will laugh</b>
<b>to leave</b>	<b>leave(s)</b>	<b>leaving</b>	<b>left</b>	<b>will leave</b>
<b>to lick</b>	<b>lick(s)</b>	<b>licking</b>	<b>licked</b>	<b>will lick</b>
<b>to listen</b>	<b>listen(s)</b>	<b>listening</b>	<b>listened</b>	<b>will listen</b>
<b>to lock</b>	<b>lock(s)</b>	<b>locking</b>	<b>locked</b>	<b>will lock</b>
<b>to look</b>	<b>look(s)</b>	<b>looking</b>	<b>looked</b>	<b>will look</b>
<b>to make</b>	<b>make(s)</b>	<b>making</b>	<b>made</b>	<b>will make</b>
<b>to march</b>	<b>march, marches</b>	<b>marching</b>	<b>marched</b>	<b>will march</b>
<b>to mix</b>	<b>mix, mixes</b>	<b>mixing</b>	<b>mixed</b>	<b>will mix</b>
<b>to mop</b>	<b>mop(s)</b>	<b>mopping</b>	<b>mopped</b>	<b>will mop</b>
<b>to mow</b>	<b>mow(s)</b>	<b>mowing</b>	<b>mowed</b>	<b>will mow</b>

<b>Verb</b>	<b>Present =  doing it now</b>	<b>Present Participle =  Incomplete action = continuous form of the verb</b>	<b>Past =  all done =  finished doing it</b>	<b>Future =  not started yet =  doing it soon or later on  Note: With pronouns "<u>I</u>" and "<u>we</u>", you can also use "<u>shall</u>" instead of "will"</b>
<b>to open</b>	<b>open(s)</b>	<b>opening</b>	<b>opened</b>	<b>will open</b>
<b>to pack</b>	<b>pack(s)</b>	<b>packing</b>	<b>packed</b>	<b>will pack</b>
<b>to paint</b>	<b>paint(s)</b>	<b>painting</b>	<b>painted</b>	<b>will paint</b>
<b>to paste</b>	<b>paste(s)</b>	<b>pasting</b>	<b>pasted</b>	<b>will paste</b>
<b>to pick</b>	<b>pick(s)</b>	<b>picking</b>	<b>picked</b>	<b>will pick</b>
<b>to plant</b>	<b>plant(s)</b>	<b>planting</b>	<b>planted</b>	<b>will plant</b>
<b>to play</b>	<b>play(s)</b>	<b>playing</b>	<b>played</b>	<b>will play</b>
<b>to pour</b>	<b>pour(s)</b>	<b>pouring</b>	<b>poured</b>	<b>will pour</b>
<b>to pull</b>	<b>pull(s)</b>	<b>pulling</b>	<b>pulled</b>	<b>will pull</b>
<b>to push</b>	<b>push, pushes</b>	<b>pushing</b>	<b>pushed</b>	<b>will push</b>
<b>to rake</b>	<b>rake(s)</b>	<b>raking</b>	<b>raked</b>	<b>will rake</b>
<b>to read</b>	<b>read(s)</b>	<b>reading</b>	<b>read</b>	<b>will read</b>
<b>to ride</b>	<b>ride(s)</b>	<b>riding</b>	<b>rode</b>	<b>will ride</b>
<b>to row</b>	<b>row(s)</b>	<b>rowing</b>	<b>rowed</b>	<b>will row</b>
<b>to run</b>	<b>run(s)</b>	<b>running</b>	<b>ran</b>	<b>will run</b>
<b>to sail</b>	<b>sail(s)</b>	<b>sailing</b>	<b>sailed</b>	<b>will sail</b>
<b>to saw</b>	<b>saw(s)</b>	<b>sawing</b>	<b>sawed</b>	<b>will saw</b>
<b>to say</b>	<b>say(s)</b>	<b>saying</b>	<b>said</b>	<b>will say</b>
<b>to scare</b>	<b>scare(s)</b>	<b>scaring</b>	<b>scared</b>	<b>will scare</b>

<b>Verb</b>	<b>Present =  doing it now</b>	<b>Present Participle =  Incomplete action = continuous form of the verb</b>	<b>Past =  all done =  finished doing it</b>	<b>Future =  not started yet =  doing it soon or later on  Note: With pronouns “<u>I</u>” and “<u>we</u>”, you can also use “<u>shall</u>” instead of “will”</b>
<b>to scream</b>	<b>scream(s)</b>	<b>screaming</b>	<b>screamed</b>	<b>will scream</b>
<b>to scrub</b>	<b>scrub(s)</b>	<b>scrubbing</b>	<b>scrubbed</b>	<b>will scrub</b>
<b>to see</b>	<b>see(s)</b>	<b>seeing</b>	<b>saw</b>	<b>will saw</b>
<b>to sew</b>	<b>sew(s)</b>	<b>sewing</b>	<b>sewed</b>	<b>will sew</b>
<b>to shout</b>	<b>shout(s)</b>	<b>shouting</b>	<b>shouted</b>	<b>will shout</b>
<b>to show</b>	<b>show(s)</b>	<b>showing</b>	<b>showed</b>	<b>will show</b>
<b>to sing</b>	<b>sing(s)</b>	<b>singing</b>	<b>sang</b>	<b>will sing</b>
<b>to sink</b>	<b>sink(s)</b>	<b>sinking</b>	<b>sank, sunk</b>	<b>will sink</b>
<b>to sip</b>	<b>sip(s)</b>	<b>sipping</b>	<b>sipped</b>	<b>will sip</b>
<b>to sit</b>	<b>sit(s)</b>	<b>sitting</b>	<b>sat</b>	<b>will sit</b>
<b>to skate</b>	<b>skate(s)</b>	<b>skating</b>	<b>skated</b>	<b>will skate</b>
<b>to ski</b>	<b>ski(s)</b>	<b>skiing</b>	<b>skied</b>	<b>will ski</b>
<b>to skip</b>	<b>skip(s)</b>	<b>skipping</b>	<b>skipped</b>	<b>will skip</b>
<b>to sleep</b>	<b>sleep(s)</b>	<b>sleeping</b>	<b>slept</b>	<b>will sleep</b>
<b>to slice</b>	<b>slice(s)</b>	<b>slicing</b>	<b>sliced</b>	<b>will slice</b>
<b>to slide</b>	<b>slide(s)</b>	<b>sliding</b>	<b>slid</b>	<b>will slide</b>
<b>to smell</b>	<b>smell(s)</b>	<b>smelling</b>	<b>smelled</b>	<b>will smell</b>
<b>to sneeze</b>	<b>sneeze(s)</b>	<b>sneezing</b>	<b>sneezed</b>	<b>will sneeze</b>
<b>to speak</b>	<b>speak(s)</b>	<b>speaking</b>	<b>spoke</b>	<b>will speak</b>

<b>Verb</b>	<b>Present =  doing it now</b>	<b>Present Participle =  Incomplete action = continuous form of the verb</b>	<b>Past =  all done =  finished doing it</b>	<b>Future =  not started yet =  doing it soon or later on  Note: With pronouns “<u>I</u>” and “<u>we</u>”, you can also use “<u>shall</u>” instead of “will”</b>
<b>to spin</b>	<b>spin(s)</b>	<b>spinning</b>	<b>spun</b>	<b>will spin</b>
<b>to stand</b>	<b>stand(s)</b>	<b>standing</b>	<b>stood</b>	<b>will stand</b>
<b>to start</b>	<b>start(s)</b>	<b>starting</b>	<b>started</b>	<b>will start</b>
<b>to steal</b>	<b>steal(s)</b>	<b>stealing</b>	<b>stole</b>	<b>will steal</b>
<b>to stop</b>	<b>stop(s)</b>	<b>stopping</b>	<b>stopped</b>	<b>will stop</b>
<b>to stretch</b>	<b>stretch, stretches</b>	<b>stretching</b>	<b>stretched</b>	<b>will stretch</b>
<b>to study</b>	<b>study, studies</b>	<b>studying</b>	<b>studied</b>	<b>will study</b>
<b>to sweep</b>	<b>sweep(s)</b>	<b>sweeping</b>	<b>swept</b>	<b>will sweep</b>
<b>to swim</b>	<b>swim(s)</b>	<b>swimming</b>	<b>swam</b>	<b>will swim</b>
<b>to swing</b>	<b>swing(s)</b>	<b>swinging</b>	<b>swung</b>	<b>will swing</b>
<b>to take</b>	<b>take(s)</b>	<b>taking</b>	<b>took</b>	<b>will take</b>
<b>to talk</b>	<b>talk(s)</b>	<b>talking</b>	<b>talked</b>	<b>will talk</b>
<b>to taste</b>	<b>taste(s)</b>	<b>tasting</b>	<b>tasted</b>	<b>will taste</b>
<b>to teach</b>	<b>teach, teaches</b>	<b>teaching</b>	<b>taught</b>	<b>will teach</b>
<b>to tell</b>	<b>tell(s)</b>	<b>telling</b>	<b>told</b>	<b>will tell</b>
<b>to think</b>	<b>think(s)</b>	<b>thinking</b>	<b>thought</b>	<b>will think</b>
<b>to throw</b>	<b>throw(s)</b>	<b>throwing</b>	<b>threw</b>	<b>will throw</b>
<b>to tie</b>	<b>tie(s)</b>	<b>tying</b>	<b>tied</b>	<b>will tie</b>
<b>to touch</b>	<b>touch, touches</b>	<b>touching</b>	<b>touched</b>	<b>will touch</b>

<b>Verb</b>	<b>Present =</b>  <b>doing it now</b>	<b>Present Participle =</b>  <b>Incomplete action = continuous form of the verb</b>	<b>Past =</b>  <b>all done = finished doing it</b>	<b>Future =</b>  <b>not started yet = doing it soon or later on</b>  <b>Note: With pronouns “<u>I</u>” and “<u>we</u>”, you can also use “<u>shall</u>” instead of “will”</b>
<b>to trick</b>	<b>trick(s)</b>	<b>tricking</b>	<b>tricked</b>	<b>will trick</b>
<b>to wade</b>	<b>wade(s)</b>	<b>wading</b>	<b>waded</b>	<b>will wade</b>
<b>to walk</b>	<b>walk(s)</b>	<b>walking</b>	<b>walked</b>	<b>will walk</b>
<b>to wash</b>	<b>wash, washes</b>	<b>washing</b>	<b>washed</b>	<b>will wash</b>
<b>to wave</b>	<b>wave(s)</b>	<b>waving</b>	<b>waved</b>	<b>will wave</b>
<b>to wear</b>	<b>wear(s)</b>	<b>wearing</b>	<b>wore</b>	<b>will wear</b>
<b>to whistle</b>	<b>whistle(s)</b>	<b>whistling</b>	<b>whistled</b>	<b>will whistle</b>
<b>to wipe</b>	<b>wipe(s)</b>	<b>wiping</b>	<b>wiped</b>	<b>will wipe</b>
<b>to work</b>	<b>work(s)</b>	<b>working</b>	<b>worked</b>	<b>will work</b>
<b>to wrap</b>	<b>wrap(s)</b>	<b>wrapping</b>	<b>wrapped</b>	<b>will wrap</b>
<b>to write</b>	<b>write(s)</b>	<b>writing</b>	<b>wrote</b>	<b>will write</b>
<b>to yawn</b>	<b>yawn(s)</b>	<b>yawning</b>	<b>yawned</b>	<b>will yawn</b>
<b>to zip</b>	<b>zip(s)</b>	<b>zipping</b>	<b>zipped</b>	<b>will zip</b>

**There are many, many other verbs and many other verb tenses too, but present, present participle, past and future verb tenses are the most important ones to know!**



## Helping Verbs...

Sometimes, **the verb** has a few extra words tied to it...  
these are called “**helping verbs**”.

**Helping verbs are used to make verb phrases...**

**I can use one or more of these along with my verb or  
action word... helping verbs can include one or  
more words...**

**These are examples of “helping verbs”...**

**do, does, did, has, have, had, is, am,  
are, was, were, be, being, been, may,  
must, might, could, should, would,  
can, shall, will, to be, to go, can be,  
must have, must have been, has been,  
is being, could have been, should be,  
will have been, might be, were  
being...**

**there are many others too...**

## Examples of sentences using different verb tenses are provided below...

1. Peter walks slowly to the store. = **Present**
2. Peter walked slowly to the store. = **Past**
3. Peter will be walking slowly to the store = **Future**

The only thing that changed in the sentence was the **verb**. All other parts stayed exactly the same!

Just changing the **verb tense** can tell me if the action is happening **now (present)**, is already **finished (past)** or **will be done soon/later on (future)**.

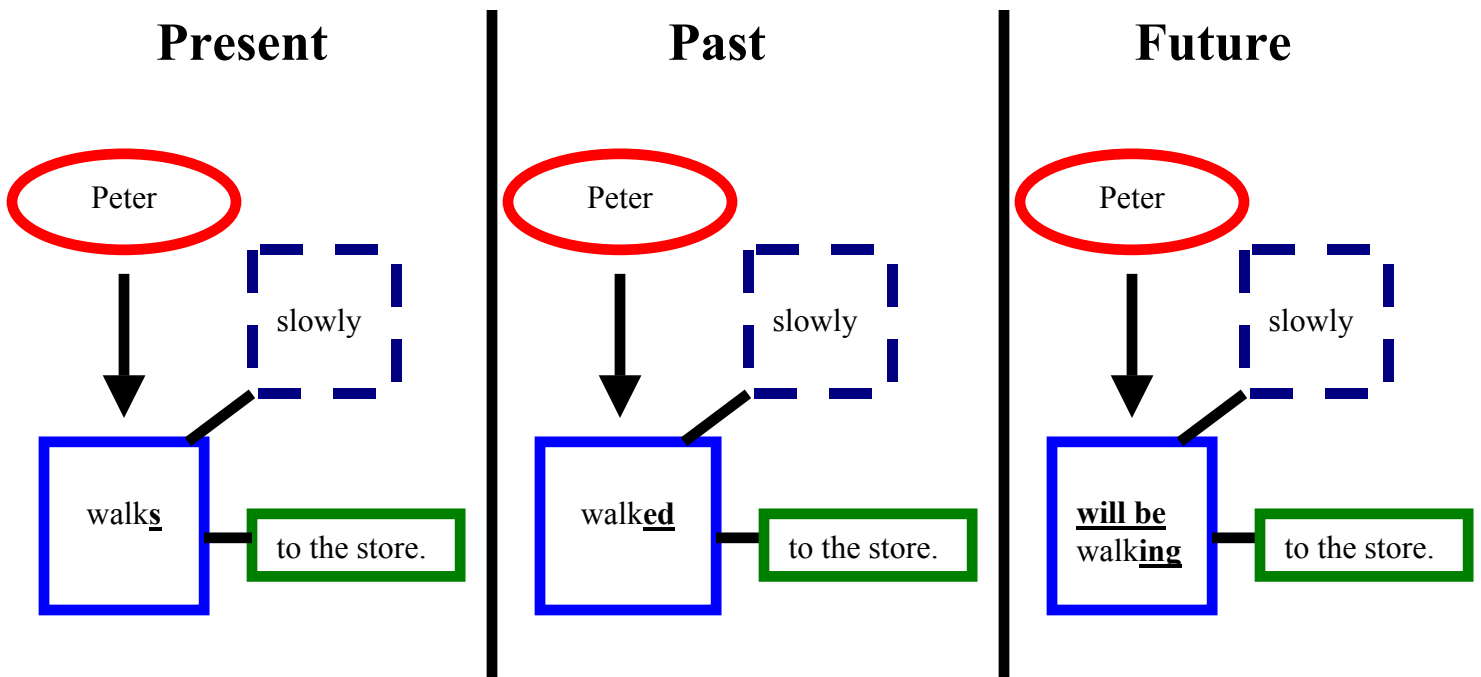

So, now I know that in my sentence train, the  
“**action word**” is the **verb**.

**the verb = sentence train engine**

And...

I know the **verb** can tell me something about the  
**action...**

It can tell me if the action is taking place **NOW...**

**NOW = Present Tense**

It can tell me if the action is already **FINISHED...**

**FINISHED = Past Tense**

It can tell me if the action has not started yet but is  
going to happen **SOON/LATER...**

**SOON/LATER = Future Tense**

**Remember:** There are many other verb tenses.  
I can learn them as I get older.

**Although computers can run some trains, most trains have a conductor...**

**a conductor = a person who drives the train**

**A sentence train has a conductor, too...**

**The person who drives the sentence train is called**

**“the subject”**

**The subject is who or what is working with the engine in the sentence train.**

**The subject = who or what the sentence is about.**

**The subject is almost always a noun.**

**Subject = sentence train conductor = noun**

# Subject

= sentence train  
conductor

= noun

Now, I need to add my sentence train conductor – **the subject** - to the sentence train engine.

**Subject = sentence train conductor = noun**

I will put my sentence train conductor – **the subject** - in an oval...

**subject**

Now, I have a conductor – **the subject** - and an engine – **the verb** - for my sentence train so, I need to put them together.

**Subject = sentence train conductor = almost always a noun or pronoun**

**A verb = the sentence engine = does something**

Since the **subject** is a **conductor** and directs the train, I will put the conductor just in front of **the verb – the engine** - in my sentence train.

**Sentence Conductor = Subject = Noun**

**Sentence Engine = Verb = Does Something**

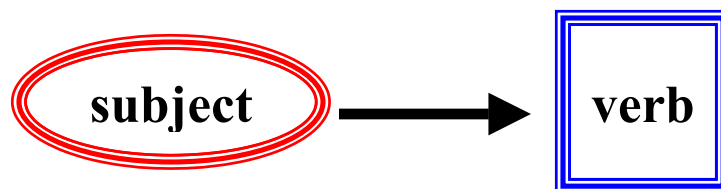

**subject = sentence train conductor = who or what  
the sentence is about**

**verb = sentence train engine = action**

## A NOUN

**A Noun = a person, place or thing**

**There are two types of nouns:**

**1. Proper nouns = name of a specific person, place or thing**

**Zachary**

**Johnson Pizza House**

**Pacific Ocean**

**2. Common nouns = most types of nouns**

**house**

**cat**

**bike**

**mother**

**beach**



**NOUN = PERSON, place or thing**

**A Person = a human = not an animal = not a thing**

**A Person = someone = somebody**

**A person is ALWAYS =**

**A BOY Or A GIRL**

**A MAN Or A WOMAN**

**WHO Is A Person?**

**A Person = somebody like...**

**PERSON = WHO = SOMEBODY**

**mom, dad, sister, brother, friend, grandma, grandpa,  
aunt, uncle, cousin, neighbor, teacher, doctor,  
fireman, policeman, mailman, painter, dancer, writer,  
farmer, clockmaker, runner, swimmer, nurse,  
construction worker, helper, babysitter, baby, artist,  
janitor, driver, train engineer, baker, butcher, judge,  
mechanic, musician, factory worker, dentist, visitor,  
repairman, storekeeper, saleswoman –  
and other people too.**

**=**

**A PERSON = SOMEBODY = SOMEONE = WHO**

**WHO IS IT?**

**A person always = a boy, girl, man, or woman.**



**BOY**



**GIRL**



**MAN**



**WOMAN**

**NOUN = person, PLACE or thing**

**A place = somewhere I can go = somewhere I can be**

**WHERE Is A Place?**

**A Place = somewhere I can go, like...**

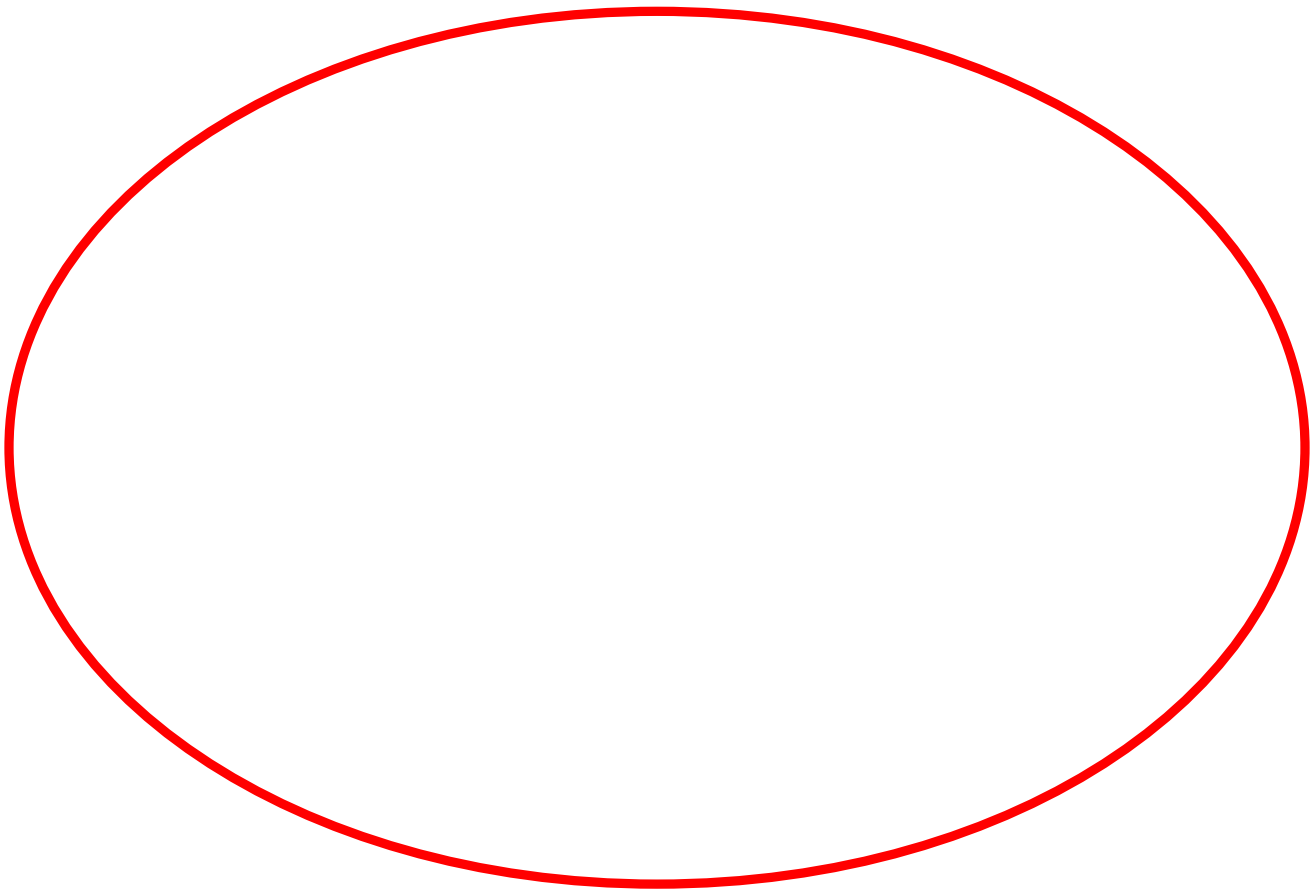

**NOUN = person, place, or THING**

**A thing = something = an object or animal**

**Almost everything is “a thing”. Many things are not alive but some are...**

**Animals, birds, insects and plants are examples of things that are alive  
but that are not persons – so, these are “things”.**

**WHAT Is A Thing?**

**A Thing = something like...**



**There are many, many things...**

**These are just a few more nouns that are “things”...**

**THING = WHAT = SOMETHING**

name, blanket, blimp, block, blouse, branch, bread, brick, bridge,  
broom, brush, butter, spoon, knife, fork, tablecloth, chain, chair,  
cheese, crackers, pot, chick, children, chipmunk, clothes, cloud, clown,  
club, crab, crumbs, crayons, crib, cross, crown, dream, dress, drum,  
flute, guitar, piano, poster, flag, flame, spark, fly, frame, picture, frog,  
fruit, glass, cup, globe, map, glove, mitten, scarf, glue, grape, grass,  
grasshopper, ladybug, snail, wasp, bee, ant, knee, knife, knock, knob,  
knot, plane, plant, plate, plum, pizza, prize, trophy, scale, scarecrow,  
corn, pumpkin, potato, carrot, shark, sheep, rabbit, skunk, spider, skate,  
shoe, ship, shell, slipper, smoke, snake, snow, spear, starfish, stick,  
stone, stove, thorn, thumb, train, tree, cactus, twig, triangle, square,  
circle, hexagon, shape, number, truck, trunk, whale, wheel, zoo,  
monkey, ear, nose, teeth, arm, leg, foot, hand, carpet, desk, computer,  
book, telephone, television, video, cd, medicine, pills, penny, dime,  
quarter, nickel, orange, lemon, apple, stairs, turtle, water, woods,  
zebra, giraffe, road, street, highway, rainbow, radio, car, shovel, rake,  
toothbrush, toothpaste, people, peas, fingers, toes, dollar, garden, hair,  
bow, arrow, lion, tiger, eraser, ladder, letter, frown, smile, face, ...

**and there are many, many other things...**

**A THING = WHAT = SOMETHING**

**So, now I know that**

**A**

**NOUN =**

**A PERSON,**

**A PLACE,**

**Or**

**A THING...**

## Pronouns...

**Pronouns = words that take the place of nouns**

So, a **pronoun** can also be the **subject** in a sentence.

**Example:**

The **truck** is red.                      **It** is red.

**It = pronoun = takes the place of “the truck”.**

**Anika** is happy.                      **She** is happy.

**She = pronoun = takes the place of “Anika”.**

The **dog** and **cat** are fighting.                      **They** are fighting.

**They = pronoun = takes the place of “the dog and cat”.**

## Pronouns...

**Pronouns = words that take the place of nouns**

So, a **pronoun** can also be the **subject** in a sentence.

**Pronouns = words that take the place of nouns**

**I, me, my, mine, he, his, she, her(s), we, us, our(s),  
they, them, their(s), you, it(s), anybody, anyone,  
another, each, either, everybody, everyone, nobody,  
no one, neither, one, other(s), someone, somebody,  
all, any, some, none, many, both, few, several,  
themselves, myself, himself, herself, ourselves, that,  
this, those, these, who, whose, whom, which, what,  
whoever, whomever, whatever, whichever ...**

**All these words are examples of pronouns that take  
the place nouns. There could be others, too.**



**So, now I know that**

**A**

**NOUN =**

**A PERSON,**

**A PLACE,**

**Or**

**A THING...**

**And, I also know that, usually,**

**only a NOUN or PRONOUN can be a SUBJECT**

**NOUN or PRONOUN =**

**SUBJECT = Who or What the  
sentence is about =**

**SENTENCE TRAIN  
CONDUCTOR**

So far, I have two parts to my sentence train...

sentence train engine = verb

sentence train conductor = subject

And, we know the **subject = noun(s) or pronoun(s)**

**Subject = Who or What the sentence is about**

**Verb = Action the subject is doing**

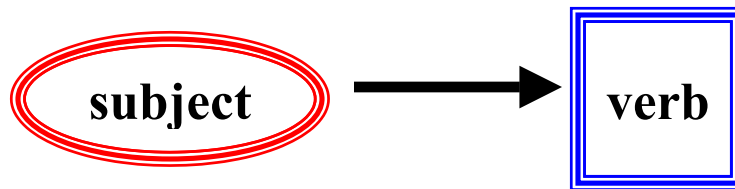

**Example:**

**Anika** laughed.

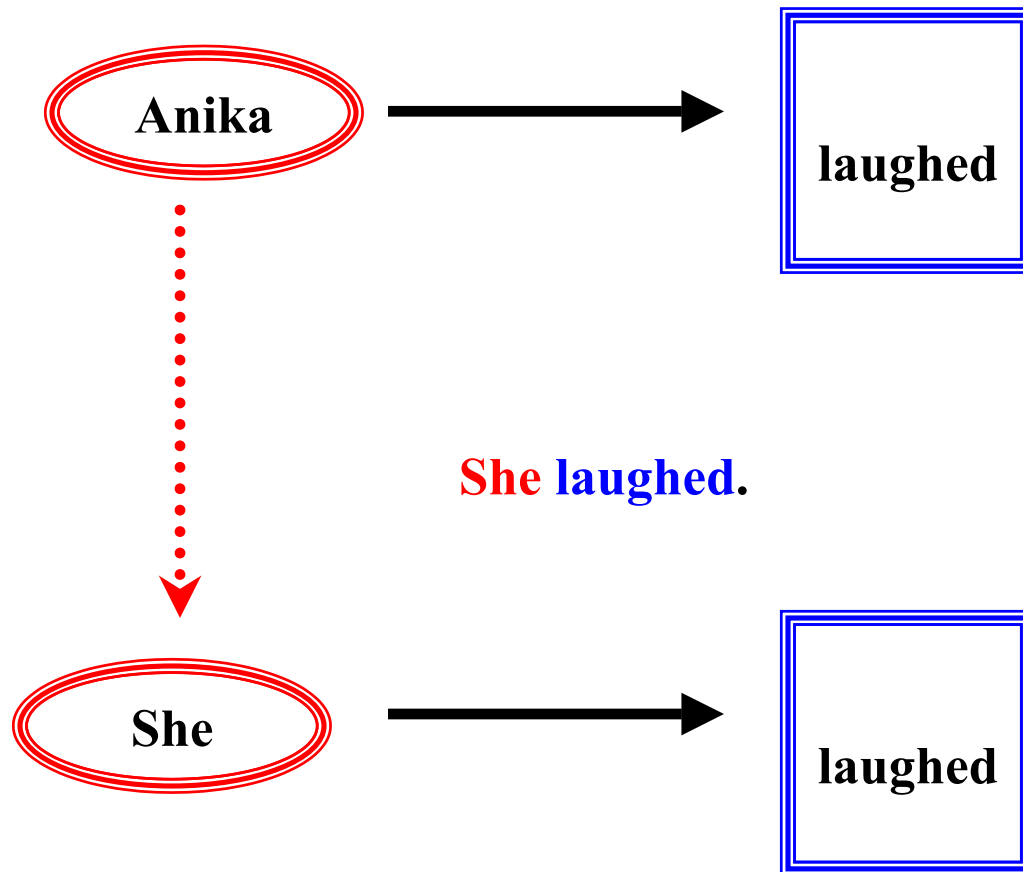

**She** laughed.

**Anika = Proper noun = name of a person = subject**

**laughed = verb**

**or**

**She = pronoun = takes place of Anika = subject**

**laughed = verb**

When people talk, they sometimes use  
“shortcuts” called  
“**contractions**”

Contractions are made of parts of 2 words...

**Contractions** can use part of a **pronoun** and  
part of a **verb** or **helping verb**...

Contractions can also use part of a **verb** or  
**helping verb** and an **adverb**...

So, they can be kind of a “**half pronoun**” +  
“**half verb**” word... or “**half verb**” + “**half**  
**adverb**” word...with some letters of either  
word “left out” and replaced by an  
apostrophe.

,

An apostrophe looks like this...

A contraction always has at least part of a **verb** or “**helping verb**” in it. The other part can be either a **pronoun** or an **adverb**.

Many contractions use the **adverb** “**not**”.

Although I use contractions in talking and writing, I will only use “full” or “complete” words in my sentence trains and will not use **contractions...**

But...

It is still important to understand **contractions** and be able to recognize what they mean.

Some **contractions** are made with **pronouns** and **verbs or helping verbs...**

<b>Pronoun</b>	+	<b>Part of Verb or Helping Verb</b>	=	<b>Contraction</b>
<b>I</b>	+	<b>am</b>	=	<b>I'm</b>
<b>I</b>	+	<b>have</b>	=	<b>I've</b>
<b>I</b>	+	<b>would</b>	=	<b>I'd</b>
<b>I</b>	+	<b>will</b>	=	<b>I'll</b>
<b>you</b>	+	<b>will</b>	=	<b>you'll</b>
<b>they</b>	+	<b>will</b>	=	<b>they'll</b>
<b>we</b>	+	<b>will</b>	=	<b>we'll</b>
<b>he</b>	+	<b>is</b>	=	<b>he's</b>
<b>he</b>	+	<b>would</b>	=	<b>he'd</b>
<b>she</b>	+	<b>is</b>	=	<b>she's</b>
<b>she</b>	+	<b>would</b>	=	<b>she'd</b>
<b>they</b>	+	<b>have</b>	=	<b>they've</b>
<b>they</b>	+	<b>are</b>	=	<b>they're</b>
<b>it</b>	+	<b>is</b>	=	<b>it's</b>
<b>who</b>	+	<b>is</b>	=	<b>who's</b>
<b>what</b>	+	<b>is</b>	=	<b>what's</b>
<b>what</b>	+	<b>will</b>	=	<b>what'll</b>

**Some **contractions** are made with the **adverb** first followed by a part of a **verb** or **helping verb**...**

<b>Adverb</b>	<b>+</b>	<b>Part of Verb or Helping Verb</b>	<b>=</b>	<b>Contraction</b>
<b>where</b>	<b>+</b>	<b>is</b>	<b>=</b>	<b>Where's</b>
<b>where</b>	<b>+</b>	<b>will</b>	<b>=</b>	<b>Where'll</b>
<b>here</b>	<b>+</b>	<b>is</b>	<b>=</b>	<b>here's</b>
<b>here</b>	<b>+</b>	<b>will</b>	<b>=</b>	<b>here'll</b>
<b>now</b>	<b>+</b>	<b>will</b>	<b>=</b>	<b>now'll</b>
<b>now</b>	<b>+</b>	<b>is</b>	<b>=</b>	<b>now's</b>
<b>there</b>	<b>+</b>	<b>is</b>	<b>=</b>	<b>there's</b>
<b>there</b>	<b>+</b>	<b>will</b>	<b>=</b>	<b>there'll</b>
<b>when</b>	<b>+</b>	<b>is</b>	<b>=</b>	<b>when's</b>
<b>when</b>	<b>+</b>	<b>will</b>	<b>=</b>	<b>when'll</b>
<b>how</b>	<b>+</b>	<b>will</b>	<b>=</b>	<b>how'll</b>
<b>how</b>	<b>+</b>	<b>is</b>	<b>=</b>	<b>how's</b>

**Other contractions “flip” the adverb and verb or helping verb information...**

**like on the next page...**

**Some contractions are made with the verb or helping verb first followed by part of an adverb...**

<b>Part of Verb or Helping Verb</b>	<b>+</b>	<b>Adverb</b>	<b>=</b>	<b>Contraction</b>
<b>Do</b>	<b>+</b>	<b>not</b>	<b>=</b>	<b>don't</b>
<b>Does</b>	<b>+</b>	<b>not</b>	<b>=</b>	<b>doesn't</b>
<b>did</b>	<b>+</b>	<b>not</b>	<b>=</b>	<b>didn't</b>
<b>Has</b>	<b>+</b>	<b>not</b>	<b>=</b>	<b>hasn't</b>
<b>Have</b>	<b>+</b>	<b>not</b>	<b>=</b>	<b>haven't</b>
<b>Had</b>	<b>+</b>	<b>not</b>	<b>=</b>	<b>hadn't</b>
<b>Is</b>	<b>+</b>	<b>not</b>	<b>=</b>	<b>isn't</b>
<b>Are</b>	<b>+</b>	<b>not</b>	<b>=</b>	<b>aren't</b>
<b>Was</b>	<b>+</b>	<b>not</b>	<b>=</b>	<b>wasn't</b>
<b>Were</b>	<b>+</b>	<b>not</b>	<b>=</b>	<b>weren't</b>
<b>Must</b>	<b>+</b>	<b>not</b>	<b>=</b>	<b>mustn't</b>
<b>Might</b>	<b>+</b>	<b>not</b>	<b>=</b>	<b>mightn't</b>
<b>Should</b>	<b>+</b>	<b>not</b>	<b>=</b>	<b>shouldn't</b>
<b>Could</b>	<b>+</b>	<b>not</b>	<b>=</b>	<b>couldn't</b>
<b>Would</b>	<b>+</b>	<b>not</b>	<b>=</b>	<b>wouldn't</b>
<b>Will</b>	<b>+</b>	<b>not</b>	<b>=</b>	<b>won't</b>
<b>Can</b>	<b>+</b>	<b>not</b>	<b>=</b>	<b>can't</b>

**There are probably other contractions, but these are the most common ones you'll here.**



Putting **contractions** in a sentence train is easy...

All I need to do is use the 2 original words that were used to make the **contraction**...

Here are a few examples of how to show **contractions** that use a **pronoun** and a **verb** or **helping verb**...

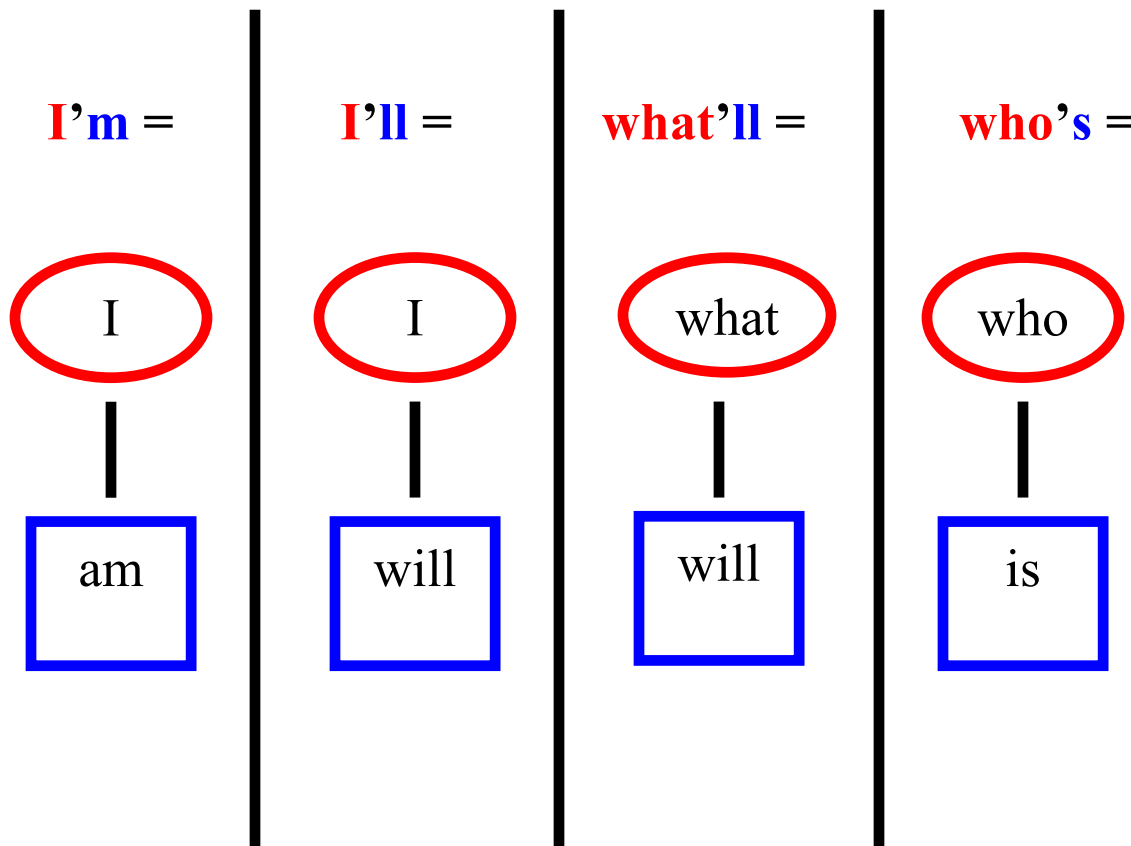

**Here are a few examples of how to show  
contractions that use an adverb and a verb or  
helping verb...**

**didn't =**

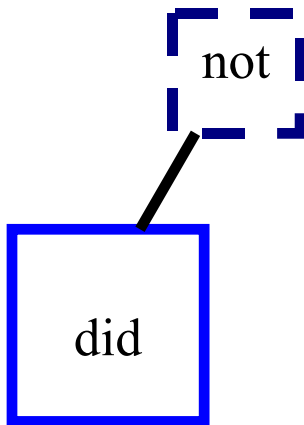

**can't =**

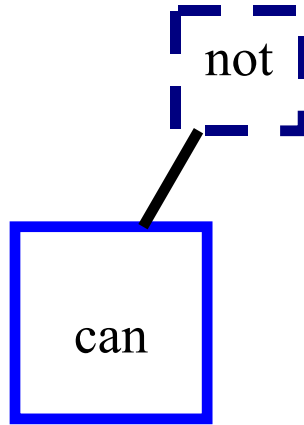

**how's =**

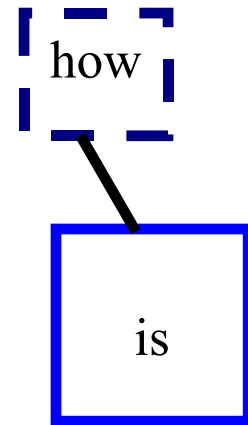

**My sentence train can have a lot more parts  
to it... like...**

**adjectives...**

**articles...**

**adverbs...**

**conjunctions...**

**prepositions...**

**etc.**

**These are all “sentence parts” I can add to a  
sentence train...**

## Adjectives...

**Adjectives = words that describe nouns = tells me something about the noun(s) = noun cargo**

**These are examples of adjectives ...**

green, blue, yellow, red, brown, black, purple, orange, white, big, bigger, biggest, tall, taller, tallest, small, smaller, smallest, fat, dirty, clean, dark, happy, sad, mad, fast, slow, long, short, beautiful, pretty, simple, old, new, favorite, round, heavy, strong, weak, fragile, broken, twisted, cracked, funny, tired, warm, cold, cool, hot, chilly, cozy, little, hungry, sick, greedy, selfish, unselfish, generous, visible, invisible, trustworthy, untrustworthy, dependable, reliable, unreliable, unbelievable, accurate, inaccurate, violent, nonviolent, destructive, nondestructive, breakable, unbreakable, aggressive, unaggressive, best, worst, jealous, sleeping, barking, quiet, shy, right, left, middle, first, second, third, fourth, last, one, two, three, four, five, some, many, more, most, only, opened, closed, squeaky, loud, soft, gentle, sensitive, bitter, sour, sweet, salty, nasty, good, bad, mean, spoiled, fussy, wealthy, poor, cute, stinky, wet, dry, huge, sore, hurt, unhurt, polished, smooth, rough, our, their, his, her, my, that, those, this, calm, afraid, unafraid, full, empty, shining, joyful, playful, sharp, dull, distant, disabled, respectful, disrespectful, dizzy, silly, easy, hard, expensive, inexpensive, real, pretend, fake, rude, polite, smart, unique, talented, victorious, wishful, opinionated, thoughtful, sneaky, friendly, live, dead, deaf, mute, silent, blind, talkative, nice, excited, frantic, free, delicate, intelligent, brave, courageous, bright, delightful, thankful, awesome, ridiculous ...

and, there are many, many more adjectives too!

## Adjectives tell me...

which one

what kind

how many

how much

whose

**Adjectives = words that describe nouns = tells me something about the noun(s) = noun cargo**

## Articles Are Adjectives Too...

**Adjectives = words that describe nouns = tells me something about the **noun(s)** = noun cargo**

**Articles = special adjectives**

**articles = adjectives**

**Articles and adjectives always tell me something about a **noun**, so, I need to tie them to a noun on the sentence train.**

**These are examples of **adjectives** called **articles**...**

**ARTICLES =**

**a, an, the  
all, every, none, some, this, that,  
these, those**

**Articles and**  
**adjectives always tell**  
**me something about a**  
**noun, so, I need to tie**  
**them to a noun on the**  
**sentence train.**

So far, my sentence train has three parts...

**the engine = the verb**

**the conductor = the subject = noun(s)**

**the noun cargo = the adjectives and/or articles that go along with the noun**

**Example: The big, red, steam train stopped.**

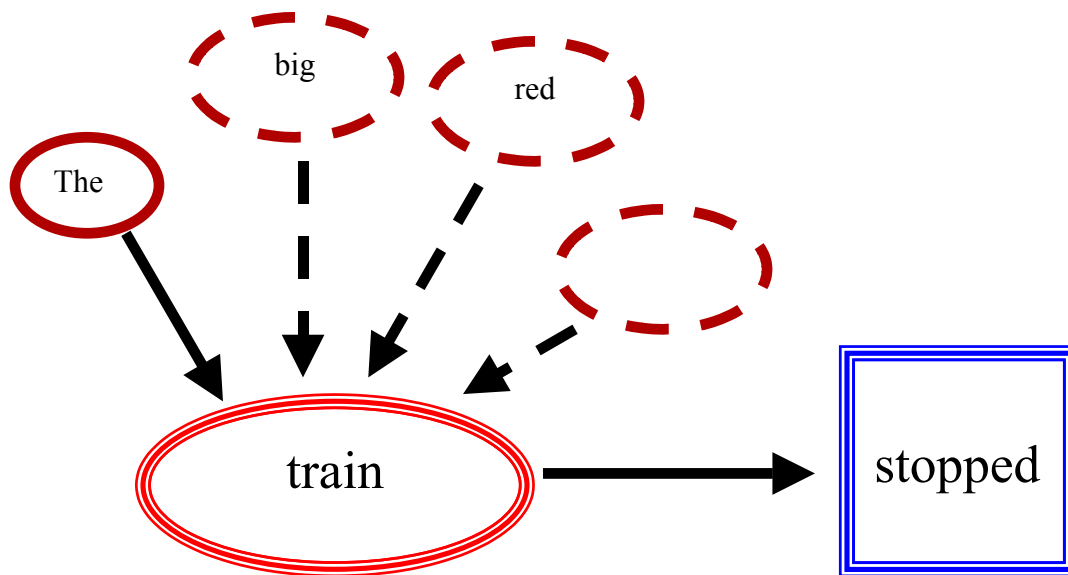

**Note: The solid arrows show the main idea in this sentence.**

**Dashed arrows show “other parts” that are extra cargo in the sentence train.**

**Extra cargo is not critical to the main idea. These “other parts” are just “nice to have” because they give more details.**



**The big, red, steam train stopped.**

**In this example...**

**cargo tied to nouns and/or pronouns**

**= adjectives and/or articles**

**adjectives = The, big, red, steam**

**conductor = subject = noun = person, place or thing**

**subject = train**

**verb = stopped**

**Putting all those words together gives me a sentence  
or sentence train that says...**

**The big, red, steam train stopped.**

**The big, red, steam train stopped.**

**Remember...**

**the sentence train conductor can also be a pronoun**  
**a pronoun = word that takes the place of a noun**

**It stopped.**

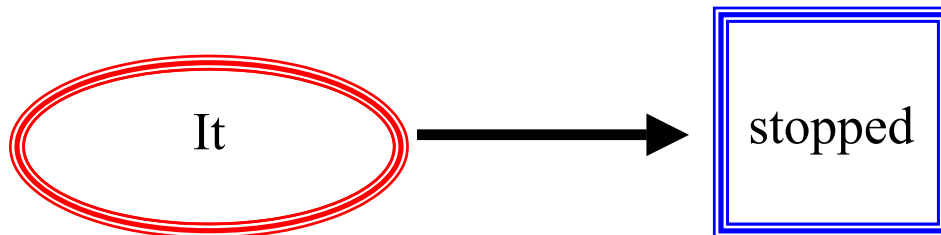

**It = pronoun**

**“It” takes the place of “The big, red, steam train”**

## Adverbs...

**Adverbs = words that describe verbs, adverbs or  
adjectives = verb, adverb or adjective cargo**

**These are examples of adverbs ...**

**An Adverb tells me...**

**When... Where... How... How Often... To What Extent...**

quietly, loudly, carefully, gently, badly, bitterly, happily, sadly, madly, richly,  
poorly, dependably, reliably, unreliably, unbelievably, accurately,  
inaccurately, violently, nonviolently, destructive, nondestructively, visibly,  
invisibly, heavily, lightly, hurriedly, generously, greedily, selfishly, unselfishly,  
aggressively, hungrily, sickly, jealously, beautifully, simply, shortly, weakly,  
quickly, slowly, joyfully, playfully, respectfully, disrespectfully, rudely, politely,  
uniquely, victoriously, wishfully, thoughtfully, silently, blindly, nicely,  
excitedly, frantically, freely, delicately, intelligently, bravely, courageously,  
lively, deadly, defiantly, sensitively, thankfully, calmly, expensively,  
inexpensively, costly, easily, hardly, warmly, coldly, tiredly, neatly, shyly,  
outrageously, ridiculously, sensitively, constantly, lovingly, energetically,  
powerfully, strongly, weakly, seriously, jokingly, urgently, casually, painfully,  
pleasantly, smoothly, harshly, tightly, loosely, solidly, frequently, rarely,  
nearly, practically, consequently, hence, here, there, everywhere, somewhere,  
nowhere, sometimes, always, never, soon, hereafter, thereafter, thereby,  
already, before, beyond, also, almost, as good as, as much as, much, somewhat,  
not, so, very, too, quite, rather, tomorrow, today, yesterday, yet, still,  
eventually, nevertheless, however, now, then...

**and, there are many, many more adverbs too!**

**Adverbs always tell me something about a **verb**, another adverb or an **adjective** so, I need to tie them to a verb, adverb or adjective on the sentence train.**

**Adverbs tell me something  
about...**

**a verb**

**another adverb**

**an adjective**

The little girl walked fast.

The little girl walked very fast.

The very little girl walked very, very fast.

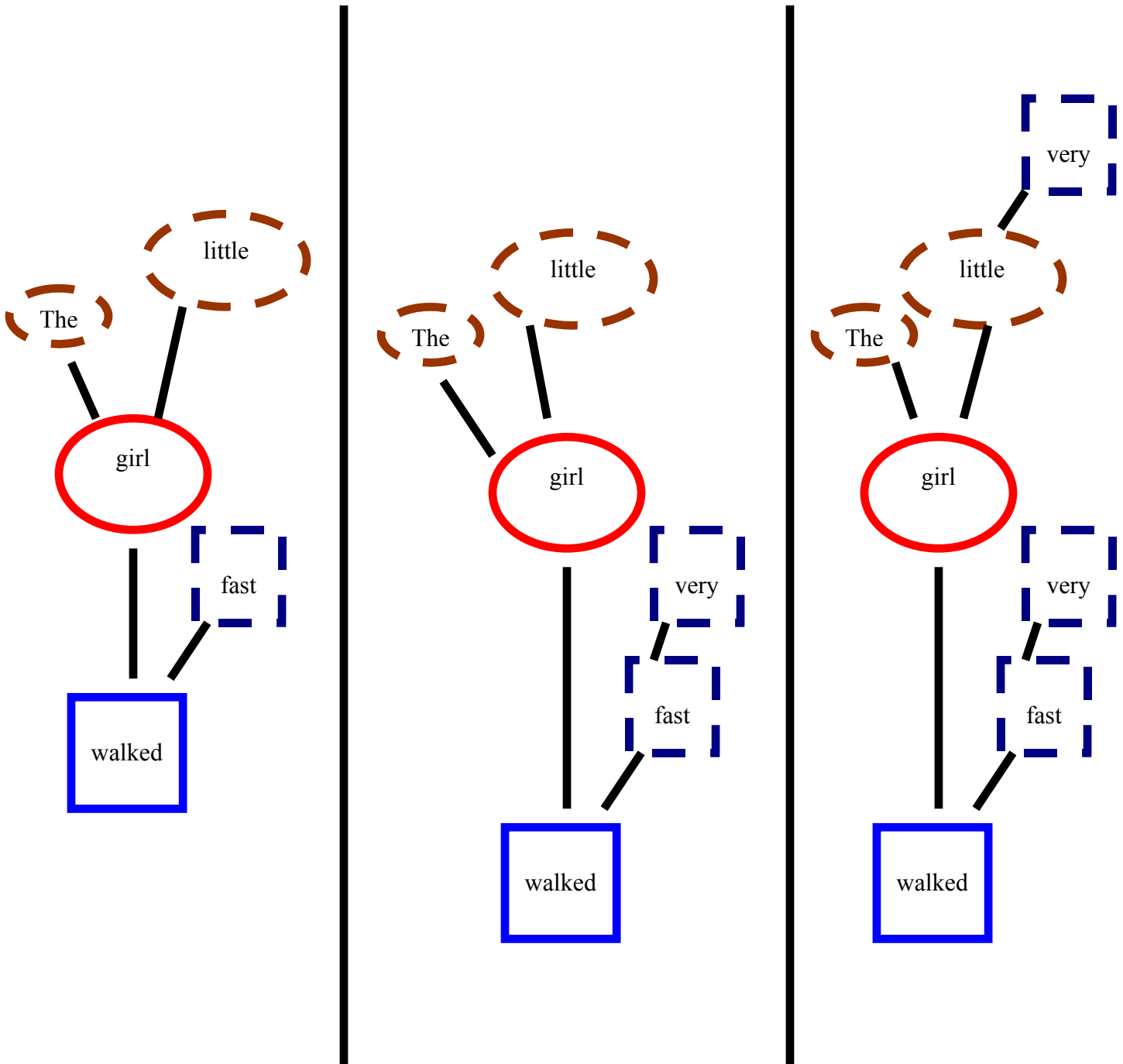

# **An Adverb Tells Me...**

**When**

**Where**

**How**

**How Often**

**To What Extent**

**I now need to put together all the sentence parts I have, so far, to make my sentence train.**

**The big, red, steam train stopped there, slowly.**

**subject = noun = conductor**

**verb = action word = engine**

**Adjectives and/or articles = noun cargo =**

**tell(s) me something about a noun**

**adjectives = tied to nouns**

**Adverbs = verb, adverb or adjective cargo**

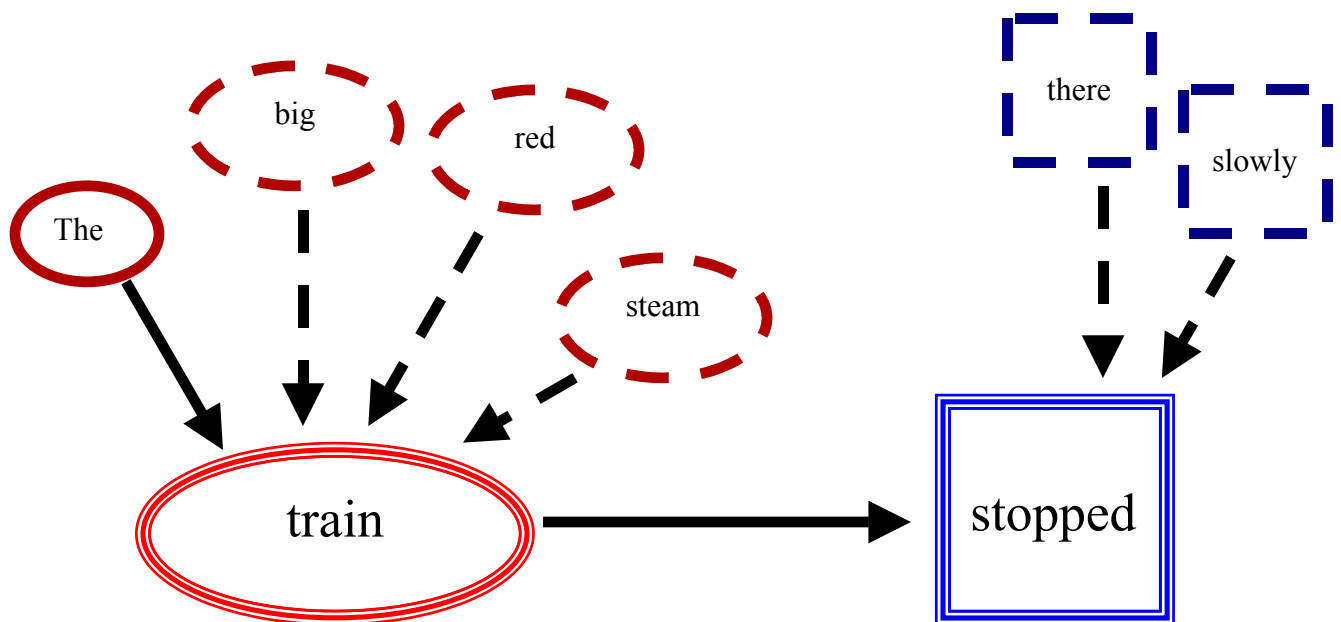



## Conjunctions...

**Conjunction = joining words = sentence train links**

**Conjunctions** are words that tie together different train parts... so, they are “**train links**”...

I will put **conjunctions** in a “**plus sign**” to show that they put train parts together...

**Conjunctions** can be single words, a group of words or two words separated by other words “in between”...

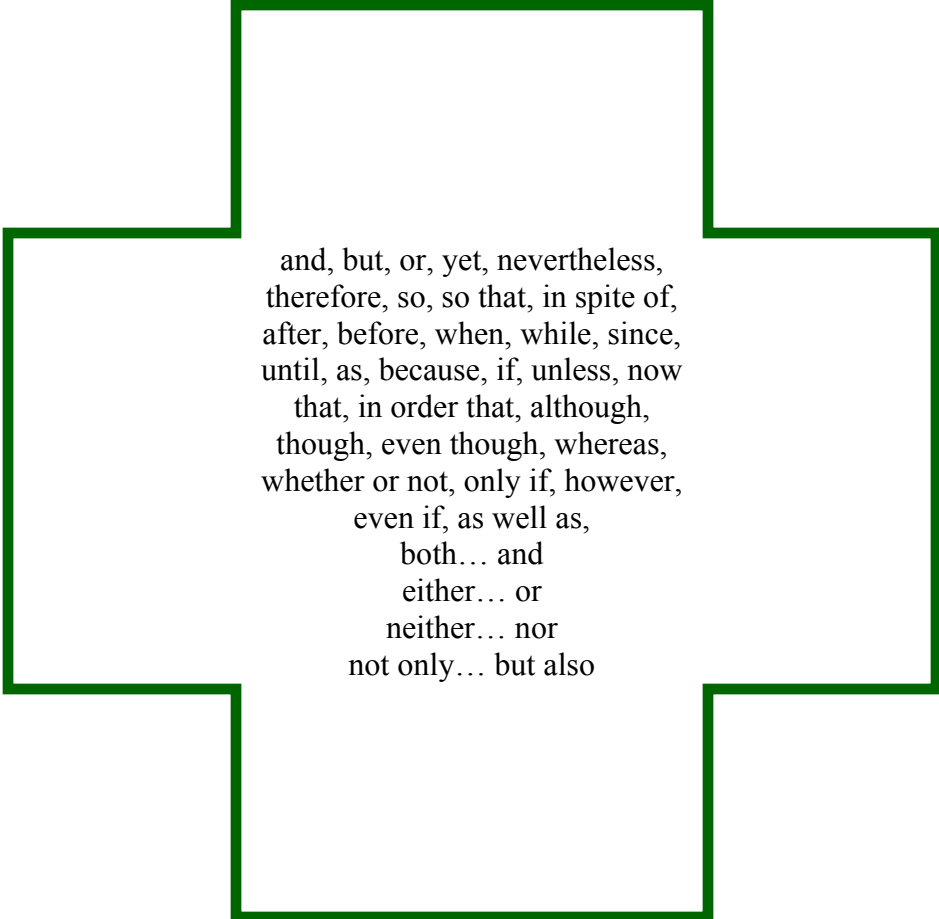

and, but, or, yet, nevertheless,  
therefore, so, so that, in spite of,  
after, before, when, while, since,  
until, as, because, if, unless, now  
that, in order that, although,  
though, even though, whereas,  
whether or not, only if, however,  
even if, as well as,  
both... and  
either... or  
neither... nor  
not only... but also

# Conjunctions...

**Conjunction = joining words = sentence train links**

## Conjunctions Join...

**Nouns**

**Pronouns**

**Adjectives**

**Adverbs**

**Prepositions**

**Phrases,**

**Etc.**

**I now need to put together all the sentence parts I have, so far, to make my sentence train.**

**Example:**

**The big, red, steam train stopped there, slowly, and reloaded carefully.**

**subject = noun = conductor**

**verb = action word = engine**

**Adjectives and/or articles = noun cargo =**

**tell(s) me something about a noun**

**adjectives = tied to nouns**

**Adverbs = verb, adverb or adjective cargo =**

**Conjunction = joining words = sentence train links**

## Example:

The big, red, steam train stopped there, slowly, and reloaded carefully.

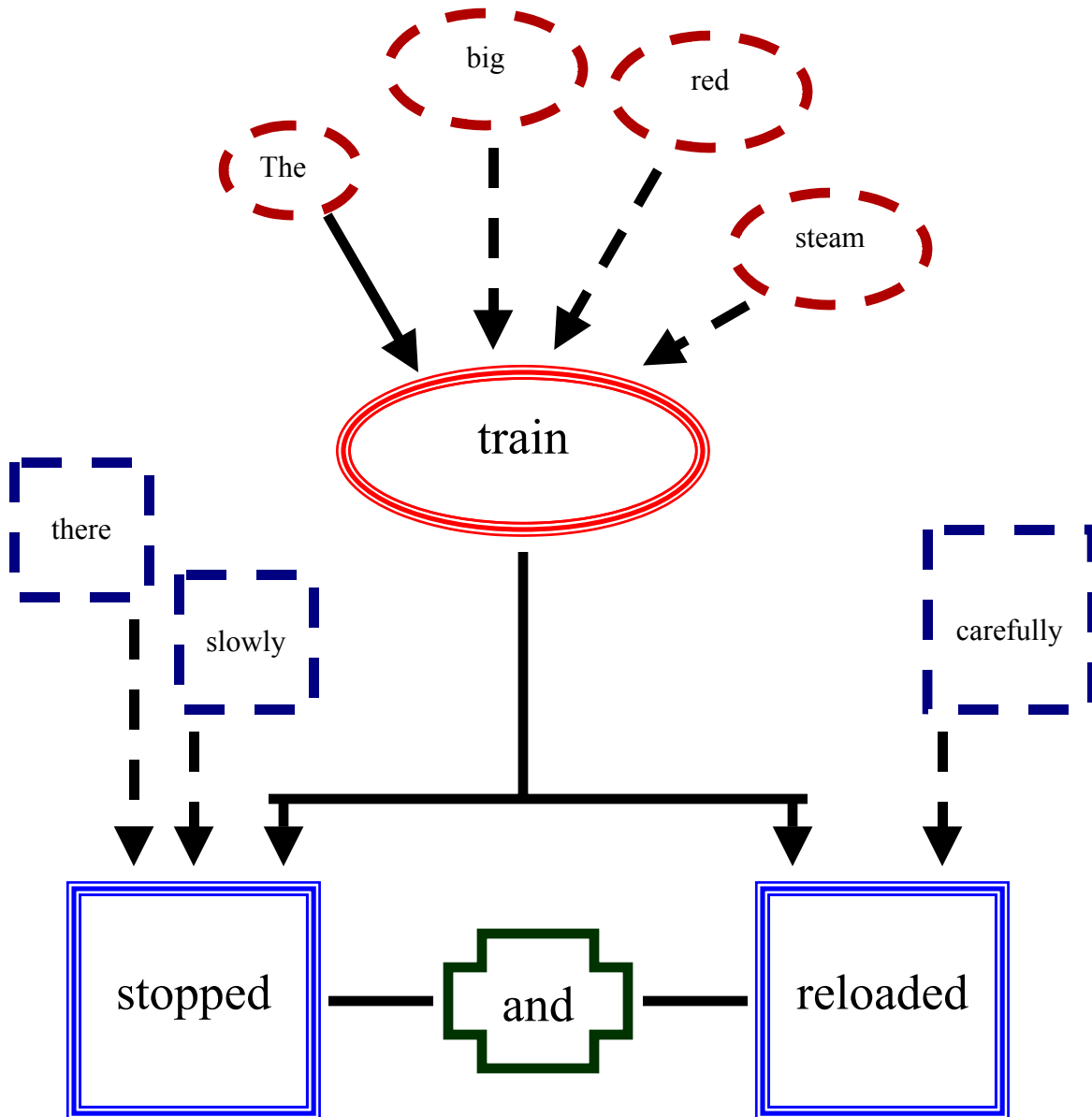

## Prepositions...

**Prepositions = words that work with other words to form a phrase**

**phrase = a group of words that express an idea or thought**

**Prepositional phrases are usually NOT the subject or verb of the sentence, so, they are “extra cargo” in the sentence and just tell me a little more information. Simple prepositions have just one word and complex prepositions have two or more words.**

**There are many prepositions... and they can be associated with nouns or verbs... so, I just have to listen to the phrase and see what word the preposition goes with...**

**These are examples of prepositions...**

**Prepositions include...**

**about, around, aboard, above, beside, besides, over, under, beneath, underneath, atop, below, behind, between, among, amid, along, across, beyond, against, before, during, after, since, until, in, out, into, onto, up, down, inside, outside, as, at, by, near, past, for, from, to, toward, on, off, of, with, without, within, except, but (= except), like, unlike, minus, concerning, considering, regarding, round, through, throughout, upon, despite, excepting, excluding, following, opposite, per, plus, save, verses, via, apart from, in spite of, because of, in view of, in addition to, by means of, contrary to, irrespective of, thanks to, in case of, in comparison with, in touch with, by way of, on behalf of, on account of, for the sake of, in exchange for, with reference to...**

**there are many others too!**

**Prepositions** can be tied to **nouns**, **subjects** or **verbs**.

**When I watch a train go by, I can usually see writing on all the train parts...**

**That writing can tell me the name of the company that owns the train.**

**That writing can also tell me what is in that train part... that is especially true if there is something dangerous, like chemicals, in the train car.**

**Each train car also has a special number on it to help the company find something fast. There can be many train cars that look the same and often, I can not see what is inside.**

**It would take a long time to find things if I had to open all the train cars.**

**The numbers on the train car help me know what is in that train car. They tell me something about that train car.**

**For example...**

**Train car no. 15 might have cars in it.**

**Train car no. 58 might have coal in it.**

**Train car no. 99 might have cows in it.**

**Train car no. 112 might have logs in it.**

**Train car no. 136 might have corn in it.**

**Train car no. 147 might have oil in it.**

**There can be many, many train parts on a train and so, to find things fast, it helps to have **labels** for all the train parts.**

**The train conductor and people at the train station have a list of all the car numbers showing what is in each train car.**

**So, the writing on the train cars provides a “**label**” or “**description**” of what is in that train part.**

**Prepositions or prepositional phrases** are like “**labels**” found on the sentence train parts...

**Remember:**

**a prepositional phrase** is a group of words that starts with a **preposition**...

Like the train car numbers or “**labels**” on a real train, **prepositions** and **prepositional phrases** help me to know something about a sentence train part...

**Prepositions** help me to identify or understand that sentence train part a little more.

Because **prepositions** are usually part of a **prepositional phrase**, I will put those words together, in a rectangle, in my sentence train.



Here are a few examples of **prepositions and prepositional phrases** that help me “**identify**” or “**understand something more**” about a specific sentence train part....

The girl **in the house** was afraid **of the dog behind the fence.**

This sentence has 3 **prepositional phrases**:

“**in the house**” tells me something about “the girl”

“**of the dog**” tells me something about “what she was afraid of”

“**behind the fence**” tells me something about “the dog”

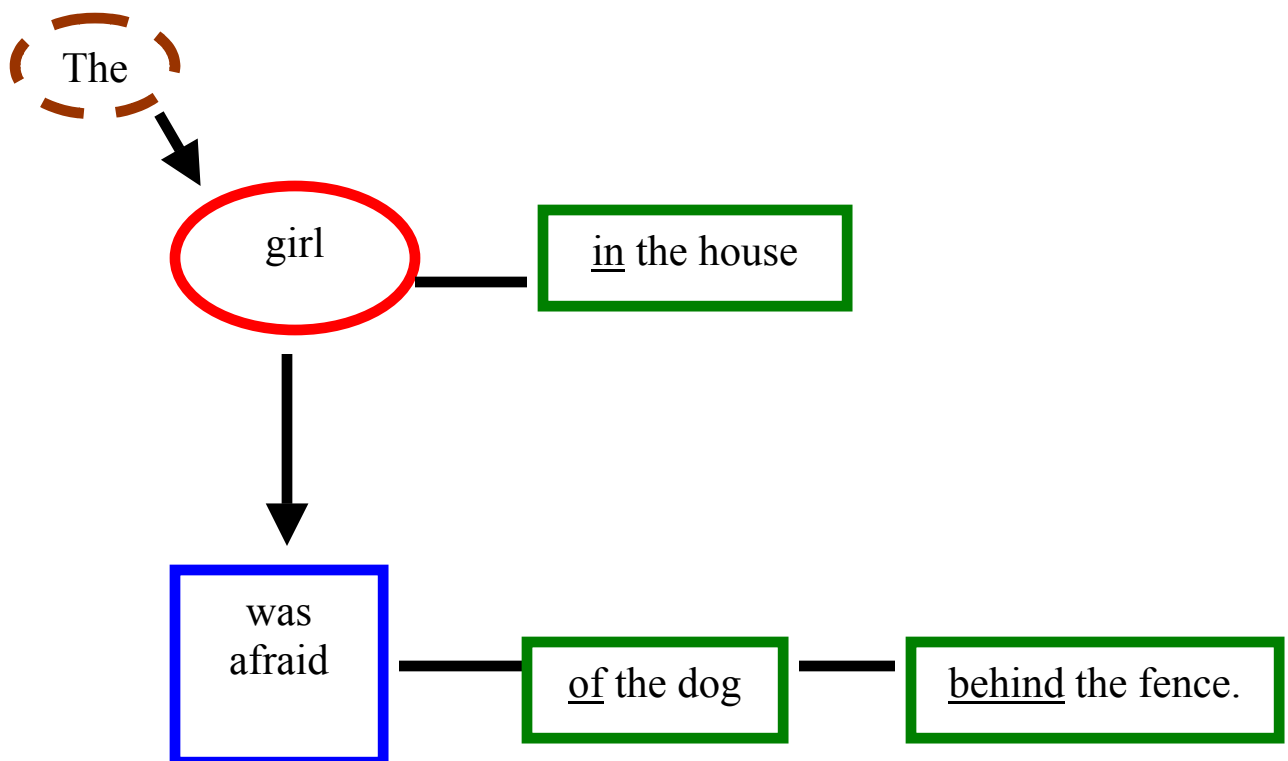

The terrible crash happened during the night.

“during the night” is a **prepositional phrase** that tells me something about “**happened**”

**Remember:** A **prepositional phrase** is a group of words that starts with a preposition...

That is why I keep the words of the **prepositional phrase** “together”.

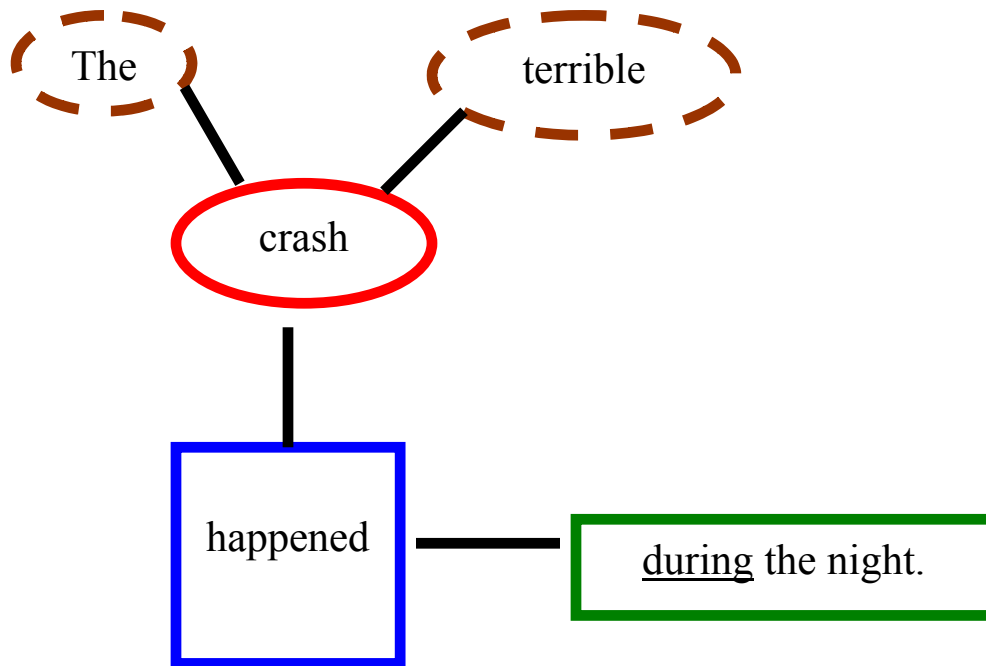

## Note To Parents...

**Just as prepositions can describe a noun, verb or direct object, there are some words that can “change jobs”, too. Some times, they can be articles, or adjectives, but at other times, they can be an adverb or direct object.**

**There are many such words...**

**The key to determining what a particular is always lies in determining what word(s) it relates to... with a little practice, this becomes much easier.**

**Example:**

**Many of the boys went to the store. (here, many is a pronoun and acts as the subject, “of the boys is a prepositional phrase).**

**The store had many boys in it. (here, it appears to act as an object of the verb – answering “had what?”)**

**They were many. (here it acts as an adverb).**

**It is important for parents to know this in order to “point out” the “role variations” you may encounter with your child...**

## Direct Object...

The **direct object** of the verb is the “**who**” or “**what**” the **action (verb)** is being “**done to**”.

To find the **direct object**, I just repeat the sentence and when I get to the **action word or verb**, I ask “**who**” or “**what**”. The answer will be the “**direct object**”.

The dog ate the bone.

The dog ate what? ... the bone

the bone = **direct object of the verb**

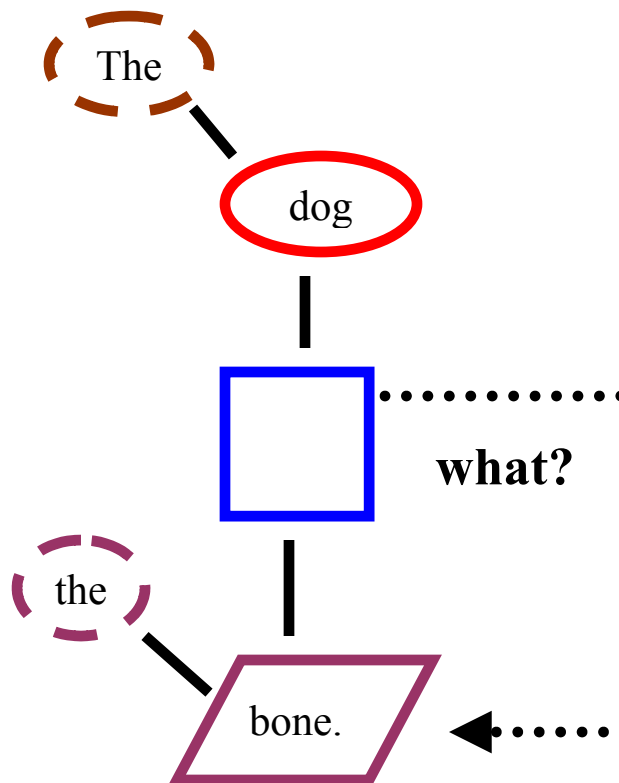

**There are times when I can have more than one direct object...**

**I gave John the book.**

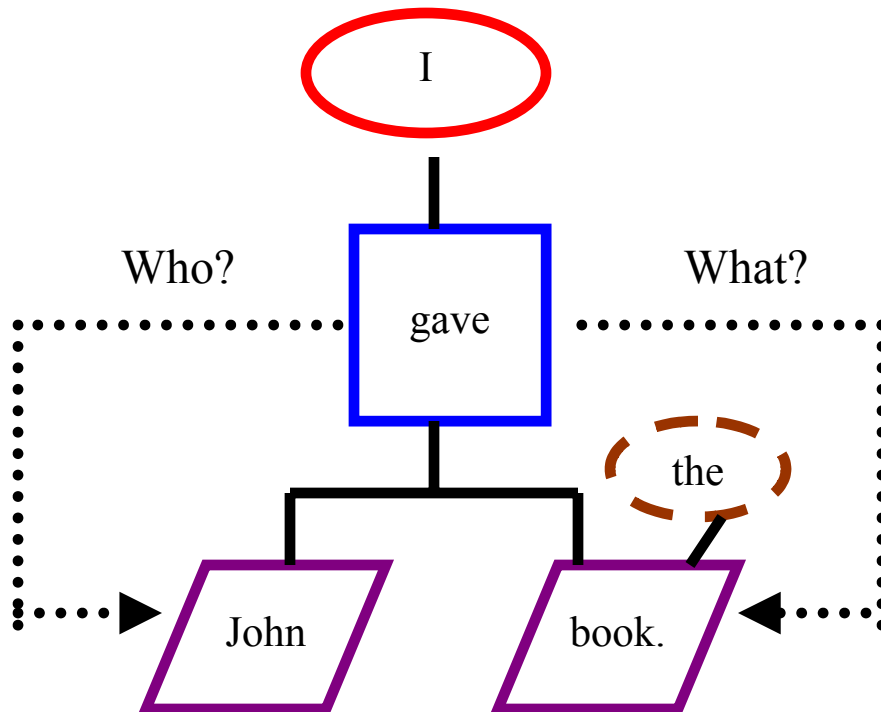

**The last part of a train is the caboose...  
that is where the train stops...**

**A sentence has a “caboose” too...**

**The punctuation mark at the end of the sentence is the  
sentence train caboose...**

**The punctuation mark shows me where the sentence  
ends and so I will find it AFTER THE LAST WORD  
in the sentence.**

**I can put the punctuation mark next to the last word  
in my sentence train, or place it after that word in a  
separate train car.**

## **Punctuation marks can look like this...**

**● = period**

**! = exclamation mark**

**? = question mark**

**there are other kinds too...**

**， = comma**

**； = semi colon**

**● = colon**

**Note: commas, semi colons, and colons are found in the sentence, but, not at the end of the sentence train. They are kind of like a “food or drink or restaurant cars” on the train...**

**They provide a place to “take a short break” or a place to “breathe in” when I am talking.**



**The sentence type tells me what kind of punctuation mark to use...**

**A “period” = “a dot” = “●” at the end of the sentence.**

**A “period” is the punctuation mark I will use most of the time.**

**A period just tells me that the sentence is finished and a new one is about to start.**

**A period is used with a “statement” type sentence.**

**Example:**

**John ate the apple.**

**My house is blue.**

**I love my mom and dad and they love me.**

**Swimming is fun if you like water.**

An “exclamation mark” = 

I use an “exclamation mark” when the sentence shows  
“excitement” or “sudden feeling”.

Here are a few examples:

**Help!**

**Look at that!**

**Wow!**

**I can’t believe it!**

**Here they come!**

**Hooray!**

**No!**

**Yes!**

A “question mark” = 

I use a question mark when the sentence is “a question” and I am asking someone something.

Questions usually start with one of these words...

<b>Am</b>	<b>How</b>	<b>What</b>
<b>Are</b>	<b>If</b>	<b>When</b>
<b>Can</b>	<b>Is</b>	<b>Where</b>
<b>Could</b>	<b>May</b>	<b>Which</b>
<b>Did</b>	<b>Might</b>	<b>Who</b>
<b>Do</b>	<b>Must</b>	<b>Why</b>
<b>Does</b>	<b>Shall</b>	<b>Will</b>
<b>Had</b>	<b>Should</b>	<b>Would</b>
<b>Has</b>	<b>Was</b>	
<b>Have</b>	<b>Were</b>	

When I see a sentence that starts with one of these words, it is probably a “question” and so, the sentence ends with a question mark... like this (?).

When asked a question, I am being asked to “give an answer to the question”.

**There are many, many ways I can answer the very same question...**

**Here are a few examples of questions and answers...**

**Question**                    **What is your name?**

**Answer**                    **My name is Zachary Brohart.**

**or**                            **My name is Zachary.**

**or**                            **I am called Zachary.**

**or**                            **Zachary.**

**or**                            **Zachary Carl Brohart.**

**Question**                    **Where do you live?**

**Answer**                    **I live in Michigan in the United States Of America.**

**or**                            **I live in Michigan.**

**or**                            **I live in a house.**

**Question**

**When do you go to bed?**

**Answer**

**I go to bed at 8:00 pm.**

**or**

**I go to bed at 8.**

**or**

**I go to bed when I am tired.**

**or**

**I go to bed when mommy or daddy says it is time for bed.**

**or**

**I go to bed when it gets dark outside.**

**Question**

**How are you?**

**Answer**

**I am fine, thank you.**

**or**

**I am fine. How are you?**

**or**

**I'm tired.**

**or**

**I'm happy.**

**or**

**I'm doing ok.**

**or**

**This is one of **my** best days ever!**

**or**

**I've never felt better!**

**or**

**I'm great!**

**Question**

**What do you like to do?**

**Answer**

**I like to play.**

**or**

**I enjoy reading.**

**or**

**I really like playing on the computer.**

**or**

**There are many things I like to do. Walking, playing, talking, dancing and swimming are just a few of the things I like to do.**

**or**

**I like eating new things.**

**or**

**When it is nice out, I like to play outside. If it is raining, I like to paint or draw on paper inside my house.**

**or**

**I love playing with my dog or my cat.**

**or**

**I love teasing my sister.**

**Question**

**Is that your cat?**

**Answer**

**No.**

**Or**

**No. It's not my cat.**

**Or**

**No. I don't know whose cat that is.**

**Or**

**No, it isn't mine, but it sure is cute.**

<b>Question</b>	<b>What time is it?</b>
<b>Answer</b>	<b>It is time to go.</b>
<b>or</b>	<b>It is time to eat.</b>
<b>or</b>	<b>It is 3 o'clock.</b>
<b>or</b>	<b>It's time for school.</b>
<b>or</b>	<b>It's time for bed.</b>
<b>or</b>	<b>It is time to play.</b>
<b>or</b>	<b>It is time for work.</b>
<b>or</b>	<b>I don't know what time it is.</b>

**So, there can be many, many answers to the same question.**

**The answer just depends on the situation and what I am doing when someone asks me a question...**

**The answer also depends on “who is asking” the question...**

**It is ok to answer some people one way... but not another...**

**My mom or dad can teach me “the right way to answer” for “different person”...**

## **Note To Parents...**

**I always try to encourage Zachary to give me “more answers” to the same question when working with him in order to help increase his flexibility and/or variety of speech.**

**I’m just starting in doing this, but, already, I see Zachary understanding that there can be “many answers” to the same question – and that is exactly the concept I am trying to teach him and that I knew he did not understand well in the past. :o)**



**When someone asks a question, they want an answer to that question... and the answer is not the same as the question...they are different!**

**There are many ways to answer a question...**

**The key is to “listen” to the question and see “what” the person asking the question wants to know.**

**There are ways to know what the answer is for a question...**

**These are a few hints...**

**The key is to pay special attention to the first word in the question...**

**The answer to...**

**“Who” questions = a person**

**“What” questions = a thing**

**“When” questions = a time**

**“Where” questions = a place**

**“Why” questions = a reason = “because”**

**“How” questions = a way**

**Who = a person**

**What = a thing**

**When = a time**

**Where = a place**

**Why = a reason**

**How = a way**

**These are the most common question types ...**

**and once I know how to answer one question, I  
can pretty well understand and figure out most of  
them...**

**I must always remember:**

**There are many ways to answer the same  
question or to say the same thing!**

**There are many ways to say the same thing...**

**Hello.**

**Hi.**

**Howdy.**

**How are you?**

**Hello. = Hi. = Howdy. = How are you? = different ways to say  
“Hello”.**

**Goodbye.**

**See you later.**

**Come back soon.**

**See ya.**

**Bye.**

**Good night.**

**Good day.**

**Goodbye. = See you later. = Come back soon. = See ya. = Bye. =  
Good night. = Good day. = Different ways to say “goodbye”.**

**In math, I can find many ways to come up with the same answer.**

**For example, there are lots of ways to equal “8”...**

<b>8</b>	<b>+</b>	<b>0</b>	<b>=</b>	<b>8</b>
<b>7</b>	<b>+</b>	<b>1</b>	<b>=</b>	<b>8</b>
<b>6</b>	<b>+</b>	<b>2</b>	<b>=</b>	<b>8</b>
<b>5</b>	<b>+</b>	<b>3</b>	<b>=</b>	<b>8</b>
<b>4</b>	<b>+</b>	<b>4</b>	<b>=</b>	<b>8</b>
<b>3</b>	<b>+</b>	<b>5</b>	<b>=</b>	<b>8</b>
<b>2</b>	<b>+</b>	<b>6</b>	<b>=</b>	<b>8</b>
<b>1</b>	<b>+</b>	<b>7</b>	<b>=</b>	<b>8</b>
<b>0</b>	<b>+</b>	<b>8</b>	<b>=</b>	<b>8</b>

**I can also find different ways to say the same thing when I am talking... and that is true for pretty well everything I say.**

**So, just like in math, there are many ways to talk and still say the same thing!**

## **Note To Parents... A Word Of Caution...**

In working with Zachary, I soon came to realize that he was confused by the questions:

**What is your name? and Who are you?**

I saw a couple of issues here...

First and foremost was the issue with “pronouns”... see my pronoun section for more on that...

The answer to both questions was “Zachary”... but, “what” is a “thing” and so, if I asked Zachary other “what questions”, at first, he started to answer “Zachary”... thinking all “what questions” had the same answer... and he associated the prompt - “what” - with an answer of “Zachary” – especially if he was very tired. “What is your name?” was one of the first things I worked on with him – long ago - and as such, that had built that “first word association” for “what questions”. “What” – to Zachary – was strongly associated with the answer “Zachary”. Much as “sit up, please” had resulted in an almost automatic response of “stand down, thank you”, so did “what questions”, initially, result in an almost automatic “Zachary” answer.

Correcting Zachary – and providing “the correct response for him” by actually telling him “what to say” was the key to overcoming this because it allowed him to eventually see that there were “other answers” to “what questions”.

This had been a difficult concept for Zachary since “what is your name” was such a common question on my part initially as I had tried to teach him his name so long ago. But, now, I realized the many issues behind communication – especially when it came to “word associations” and as such, I saw this particular issue had several “traps” in it.

I knew there was another reason Zachary had been confused by this. The answer to “What is your name” is – a thing – “a name”, but, in this case, it also is an answer to “who” and Zachary had a difficult time with that.

**A name = thing = “what”**

**A person = who**

“what” does not usually = “who” and as such, in this instance of “a name” it was important Zachary understand that the “what” was “his name” and not “who” he was because “who” was indicative of “a person” – not a thing!

Now that Zachary had a better understanding of language, this issue had greatly subsided, but, every once in a while, I still see it pop up and so, I wanted to raise it for parents.

Just something to keep in mind and to watch for...

## Note To Parents...

Questions are a little harder to put in bubble graphs.

In a question, the words not only get “moved around” but they also change (i.e., verb tense, role, etc.).

As such, I do not plan on attempting to “graph” questions with Zachary. I may do a few here and there, but, personally, even I found it challenging to graph a question. As such, I did not go into much detail when it came to “graphing questions in these materials. All I wanted to do was introduce Zachary to the idea that with “a question”, the words “move around”.

When you started to look at “questions”... it was easy to see how quickly they became difficult to graph. Take for example the following:

I was going to the store.

Was I going to the store?

This is a simple sentence to graph as “a statement” or “an exclamation”... but, as a question, it becomes more complex... because the verb gets “split apart”... and so you need to actually make 2 verb boxes... even though as a statement or exclamation, you can easily just include the helping verb in the box with the primary verb.

Needless to say, this is not a level of difficulty Zachary – or I - needed to get into at this time... If he asked me to graph a question, I would attempt to do so, but otherwise, I planned on staying away from graphing these – at least for now.

I provided an example on the following page... but, honestly, I was not 100% sure as to whether or not it was correct. I simply wanted to provide the “concept” that words change around when we use questions in speech.

So, if my next example is incorrect, I apologize for that... and encourage any grammar expert out there to let me know the correct way to graph this question. Actually, a few examples would be greatly appreciated... I could then put them in these materials as updates under Parent Teaching Tools. :o)

**Just as there are different kinds of trains... like a steam train, an electric train or a diesel train... there are different types of sentence trains, too!**

**There are 3 primary sentence types:**

- 1. A statement**
- 2. An exclamation**
- 3. A question**

**Statement:           The house is blue.**

**Exclamation:        The house is blue!**

**Question:            Is the house blue?**

**Now let's look at the bubble graphs for these different types of sentences...**

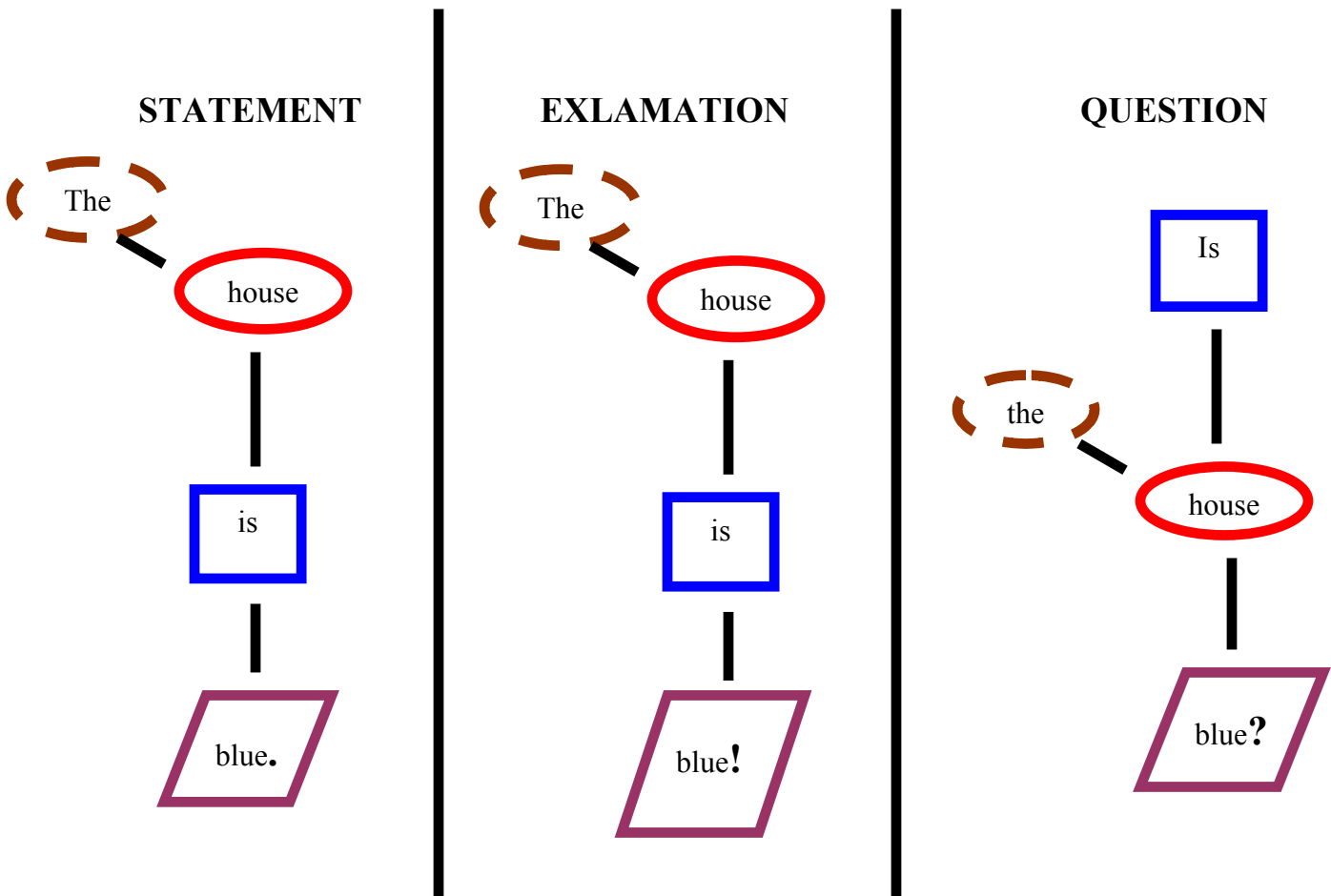



**The following pages provide practice bubbles graphs...**

**I can use the word lists provided for articles, adjectives, nouns, verbs, adverbs, conjunctions, prepositions, and contractions to help me build sentence trains...**

**I can also use onomatopoeias and compound words to create fun sentences.**

**I will make a sentence with just one word...**

**Remember: When a sentence has just one word, it is usually a **verb!****

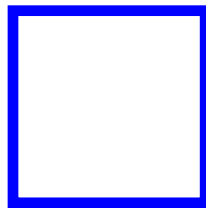

**I will make a sentence that has a subject and a verb...**

**I will use my name as the subject...**

**Then I will try making the same sentence using a pronoun to take the place of my name...**

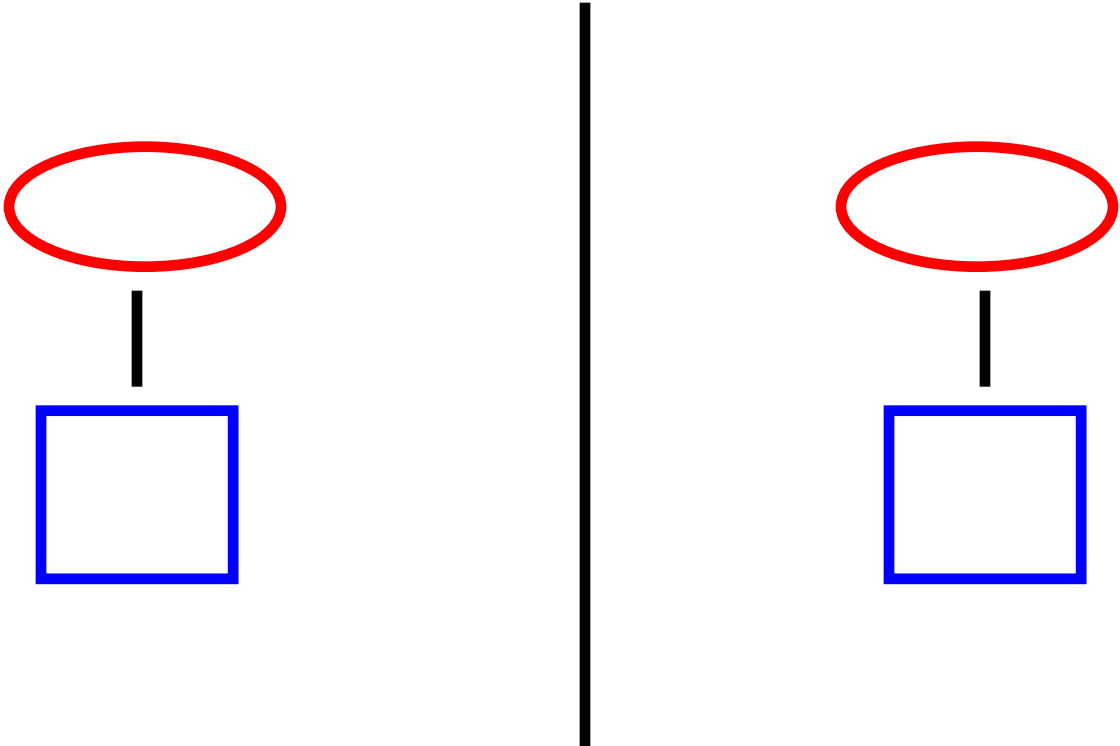

**I will make a sentence that has an article, a subject and a verb...**

**Then I will try making the same sentence using a pronoun to take the place of the subject...**

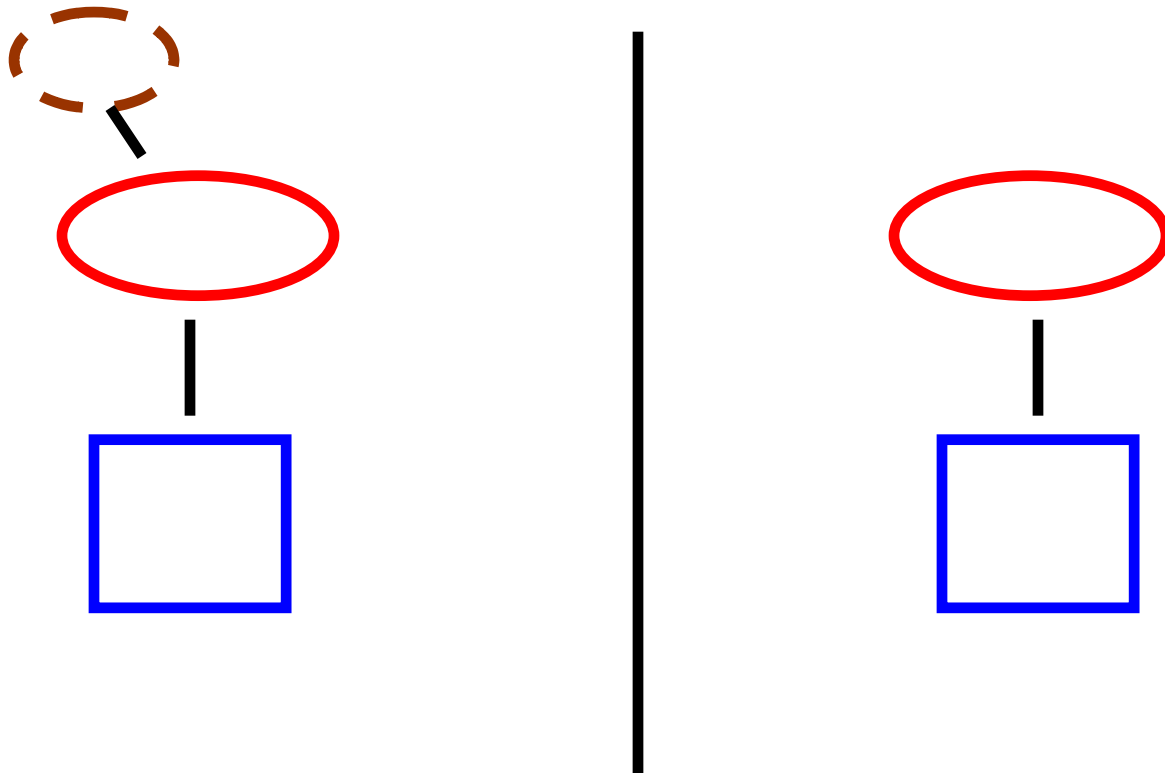

**Now, I will make a sentence with an article, an adjective, a subject and a verb...**

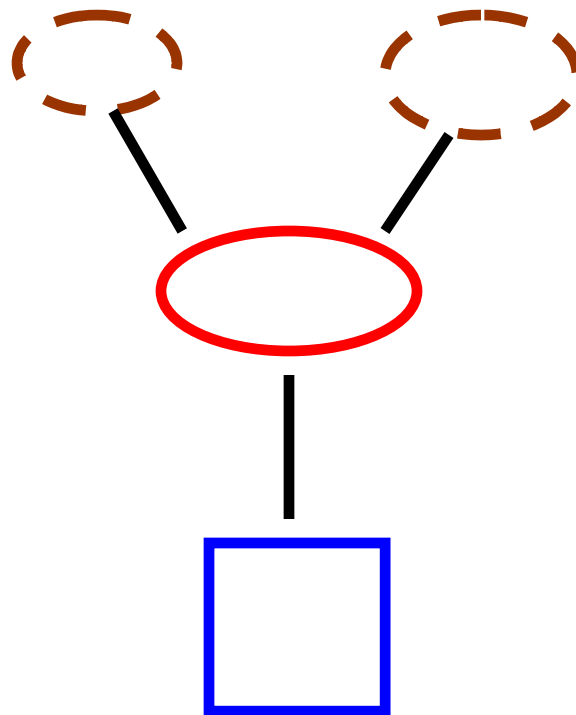

**I will write a sentence with an article, adjective, subject and verb and then write the sentence using a pronoun instead as the subject...**

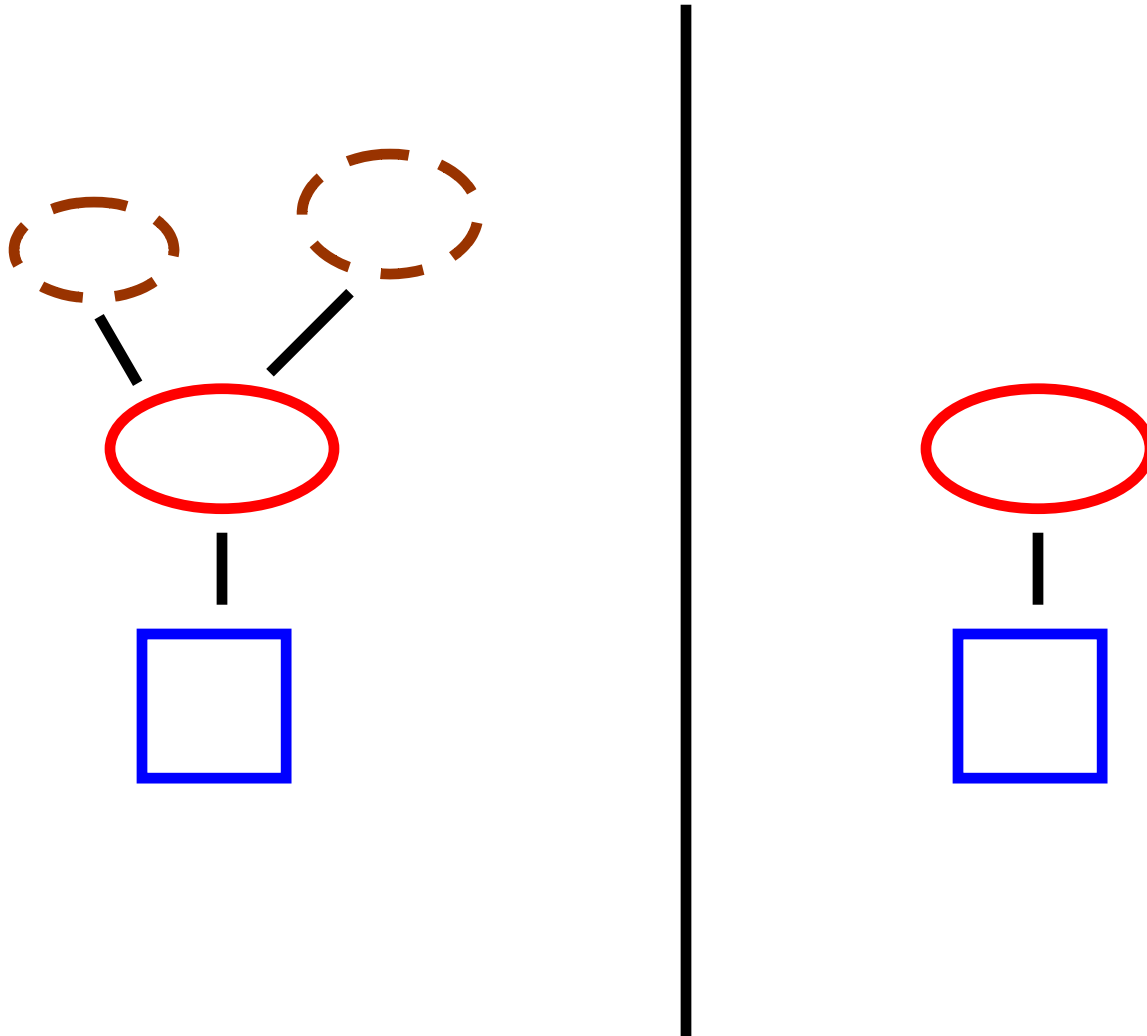

**I will write a sentence with an article, adjectives, a subject and a verb and then, write the same sentence using a pronoun...**

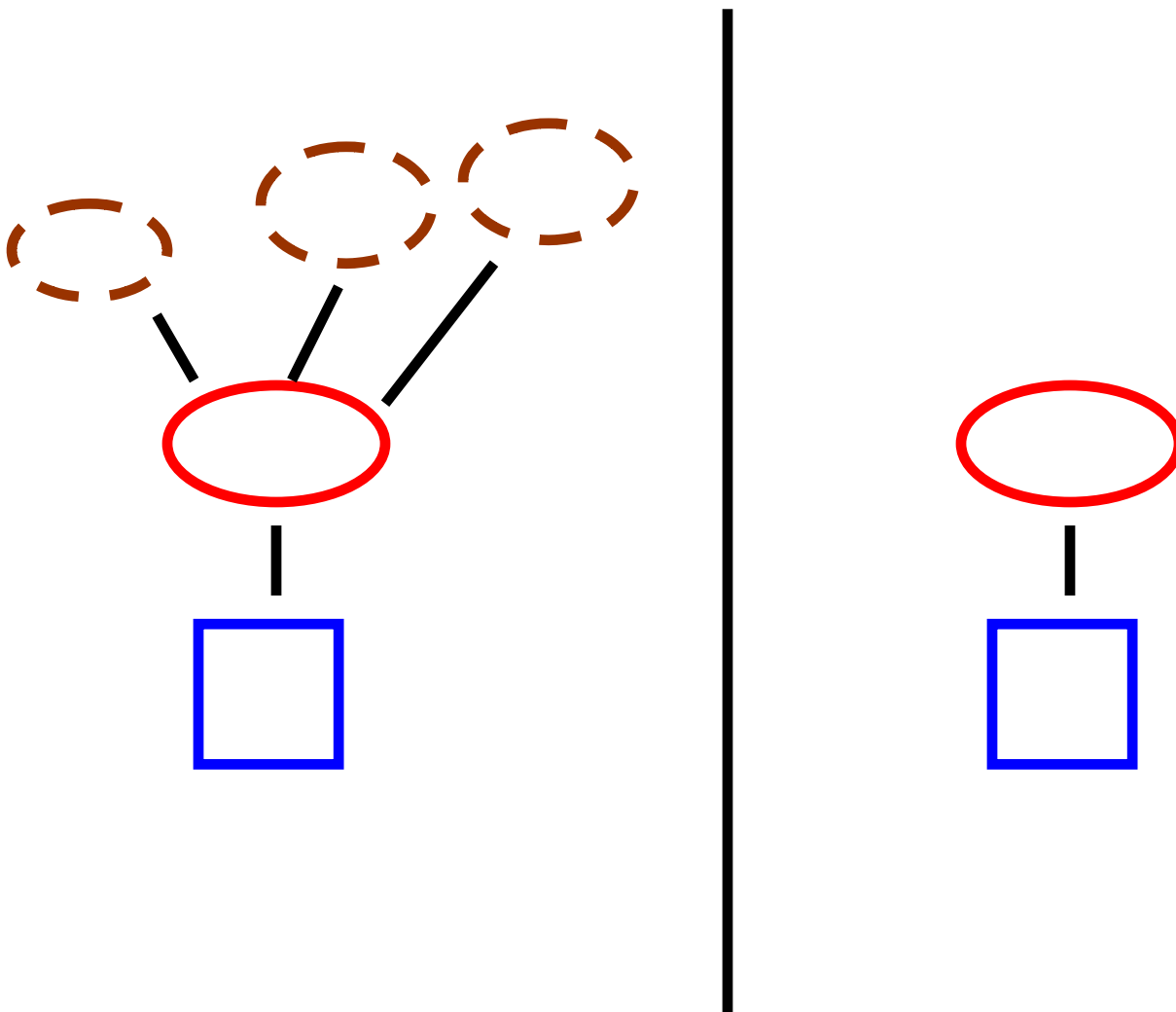

**Now, I will add in another adjective...**

**Note: I can see that it does not matter how many more adjectives I add in... the sentence stays the same when I use a pronoun as the subject...**

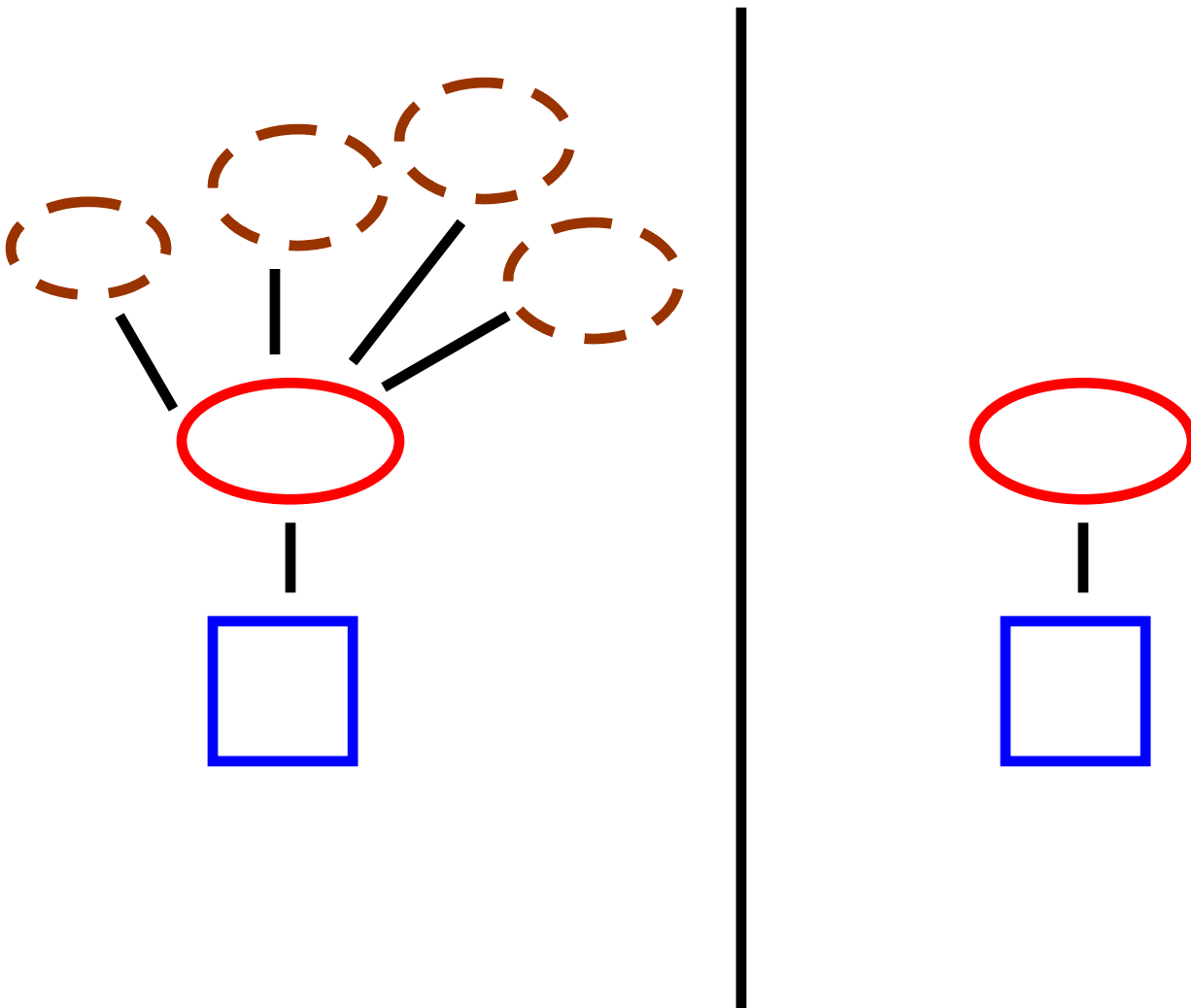



**Now, I will add in another subject and join the two subjects with a conjunction.**

**In this sentence, I will use my name and the name of someone I know as the subjects.**

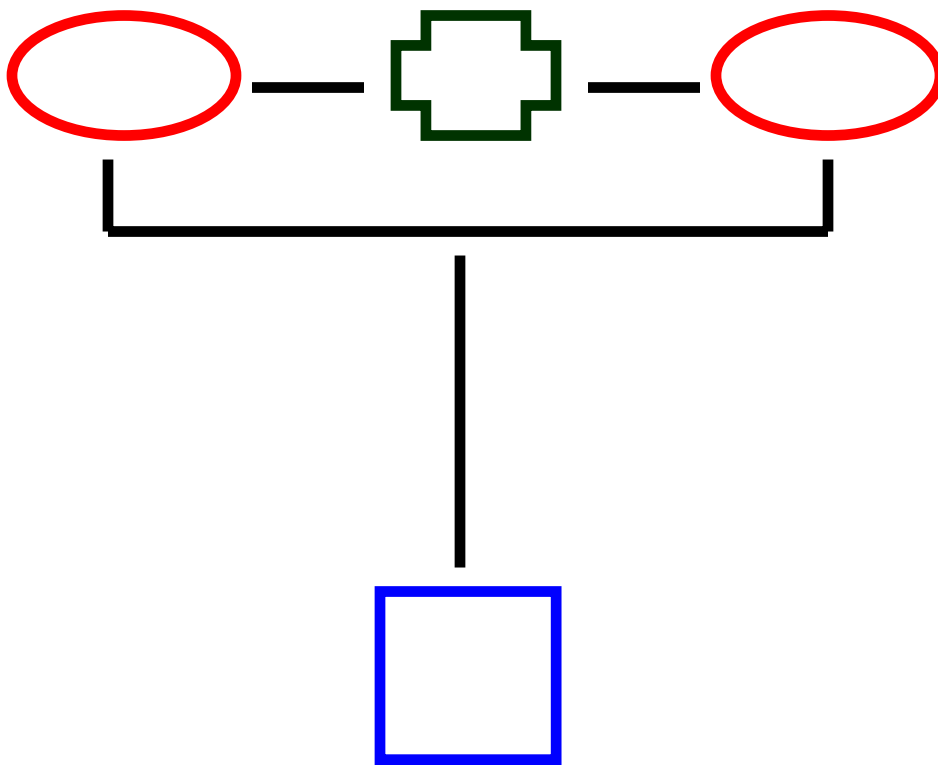

**I will write a sentence with two subjects and one verb.  
I will join the two subjects with a conjunction and then  
write the same sentence using a pronoun to replace the  
subject information...**

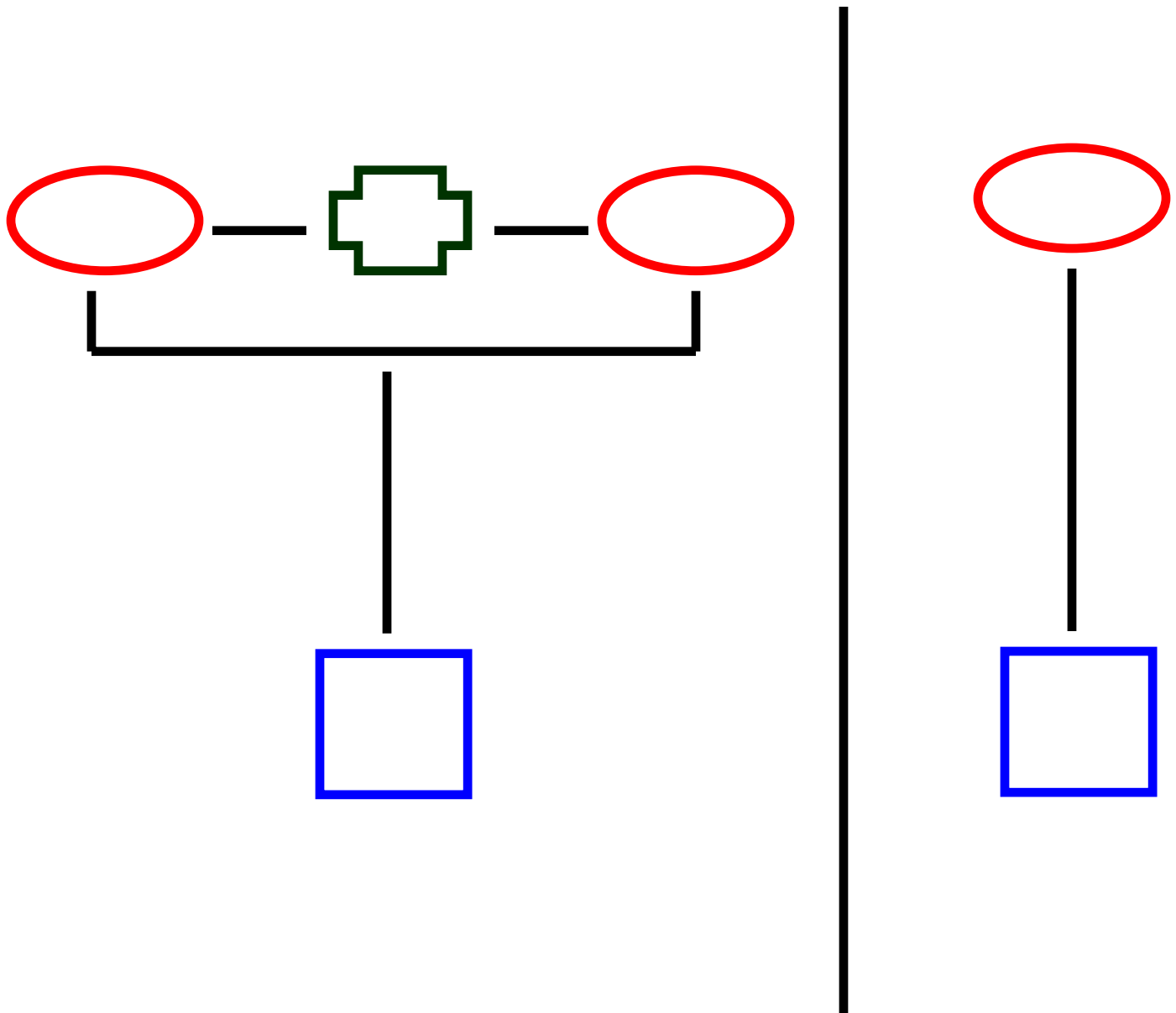

**I will write a sentence with two subjects, two articles and a verb and join the two subjects with a conjunction.**

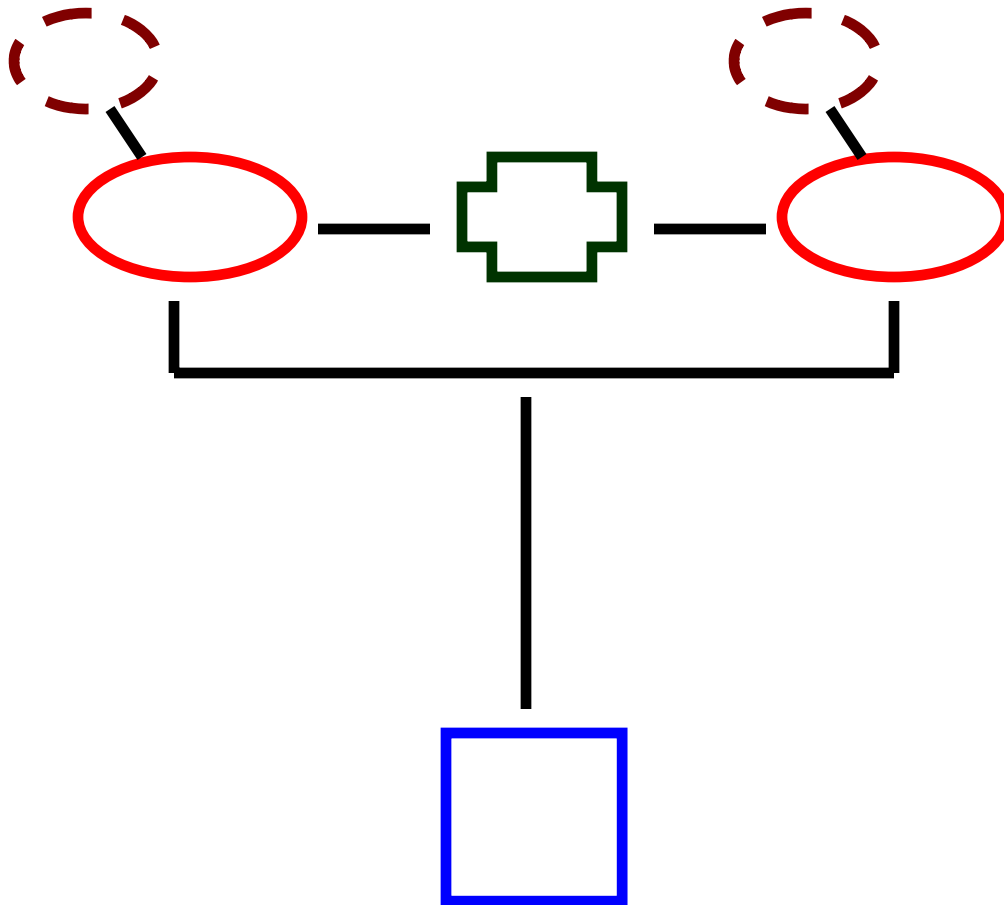

**I will write a sentence with three subjects, one conjunction and one verb... and then, write the same sentence using a pronoun to take the place of all subjects...**

**I will use my name and the name of two other persons in this sentence...**

**I can see that adding another subject does not change the sentence using a pronoun.**

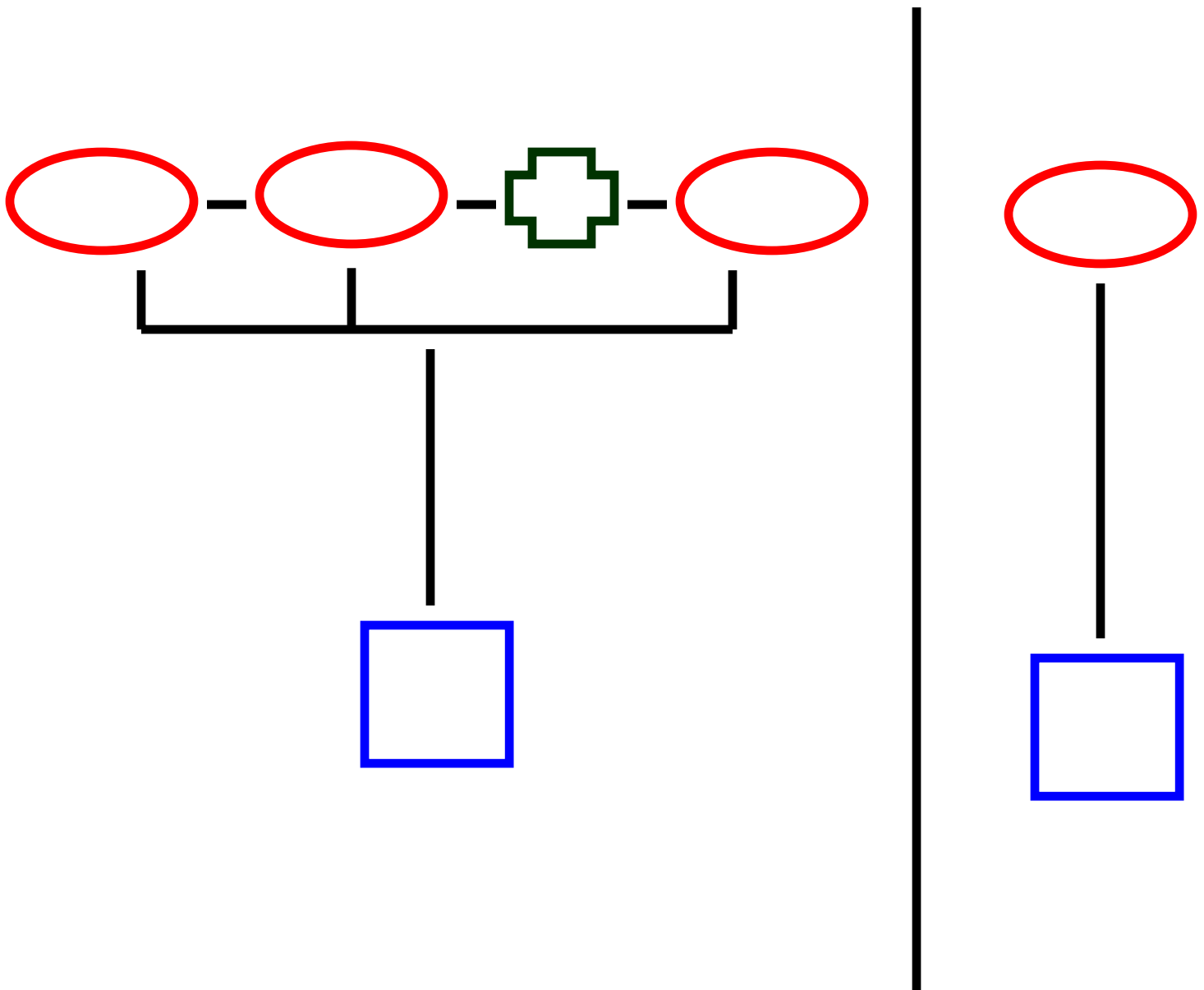

**Now, I will write a sentence using three subjects and I will add in some articles and adjectives...**

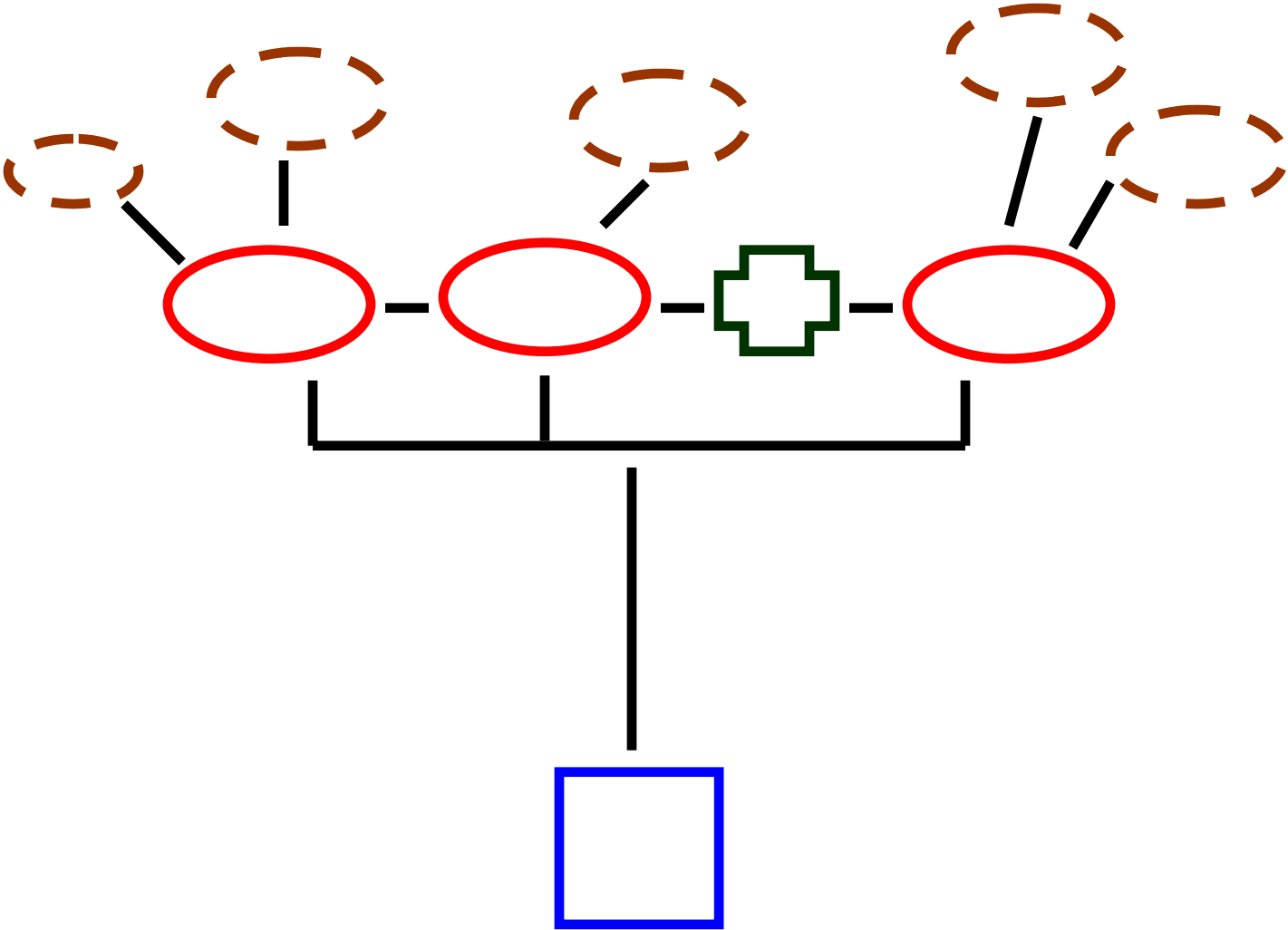

I will write the a sentence and then replace the subject information with a pronoun...

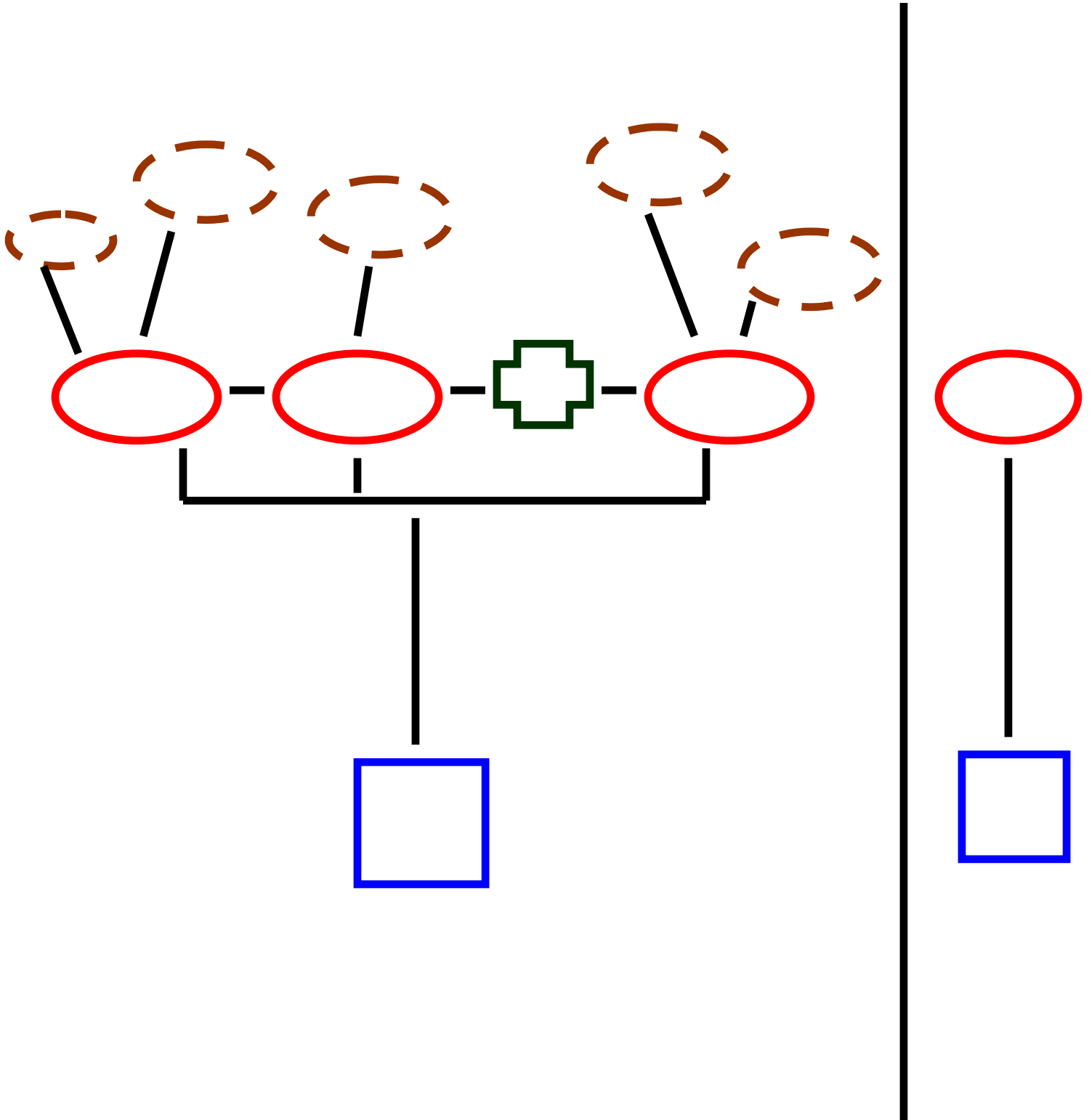

**In this sentence, I will add in a prepositional phrase...  
and then write the same sentence using a pronoun to  
replace the subject information...**

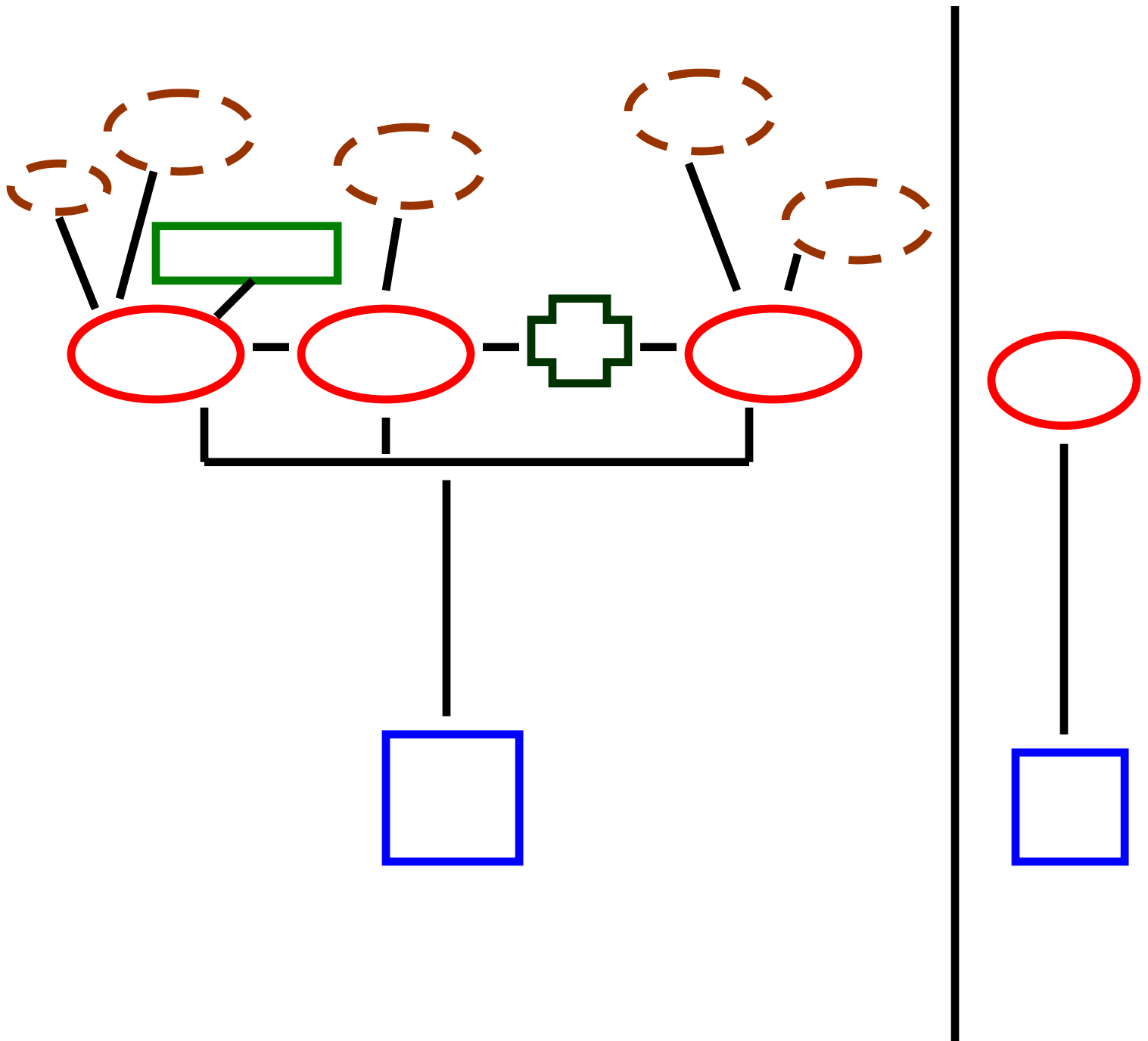

**I can add in more prepositional phrases... and see that when I use a pronoun... one pronoun can take the place of all that subject information...**

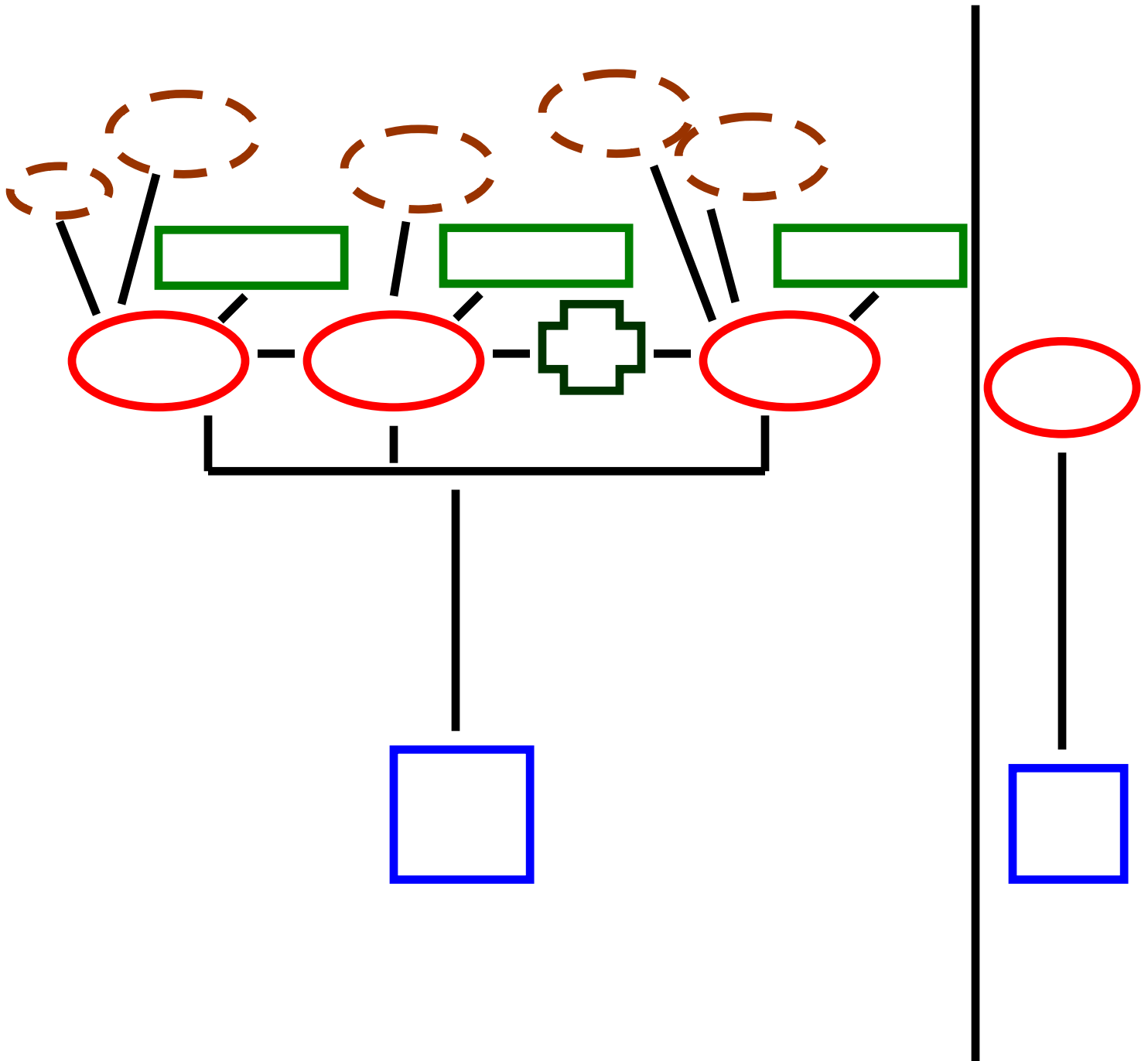



**Sometimes, I need to talk about myself...**

**This is a simple sentence using only my name and an action verb...**

**In second sentence, the pronoun “I” takes the place of my name.**

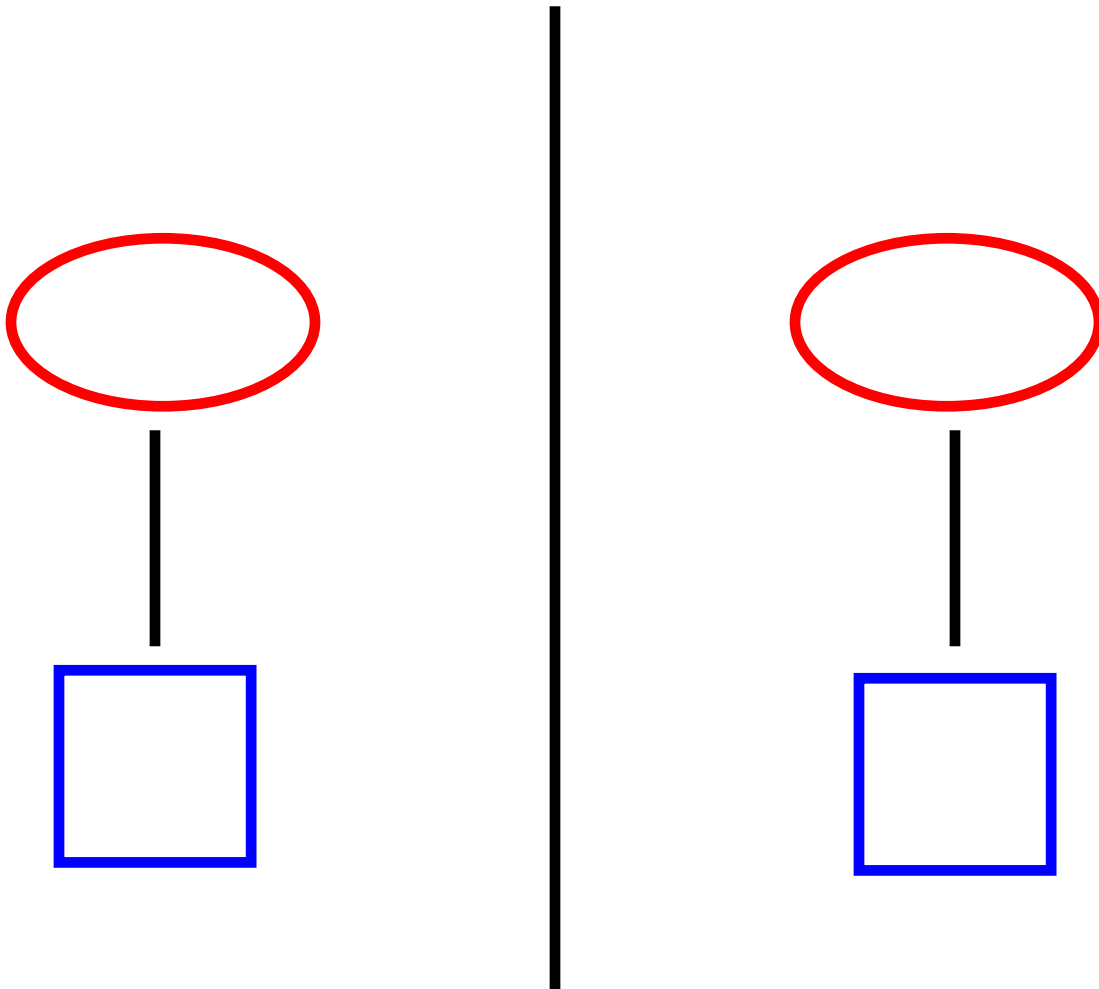

**Now, I will add another person to my sentence...**

**I will still include my name as one of the subjects in the first sentence...**

**In sentence 2, a pronoun takes the place of my name.**

**In sentence 3, a pronoun takes the place of both names.**

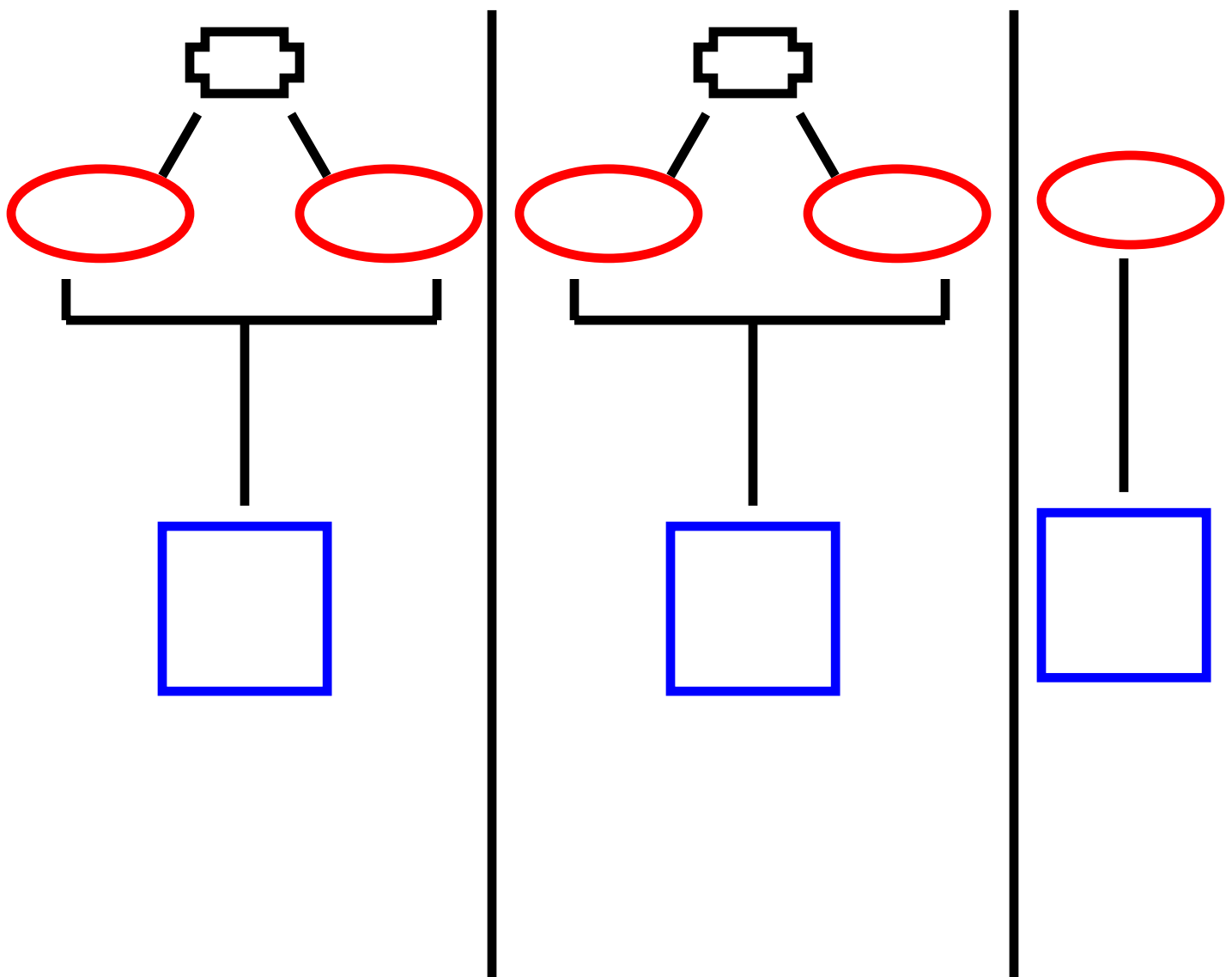

**Now, I will add another person to my sentence...  
I will still include my name as one of the subjects in  
the first sentence...**

**In sentence 2, I replace my name with a pronoun.  
In sentence 3 I replace all names with a pronoun.**

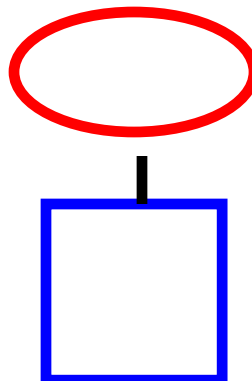
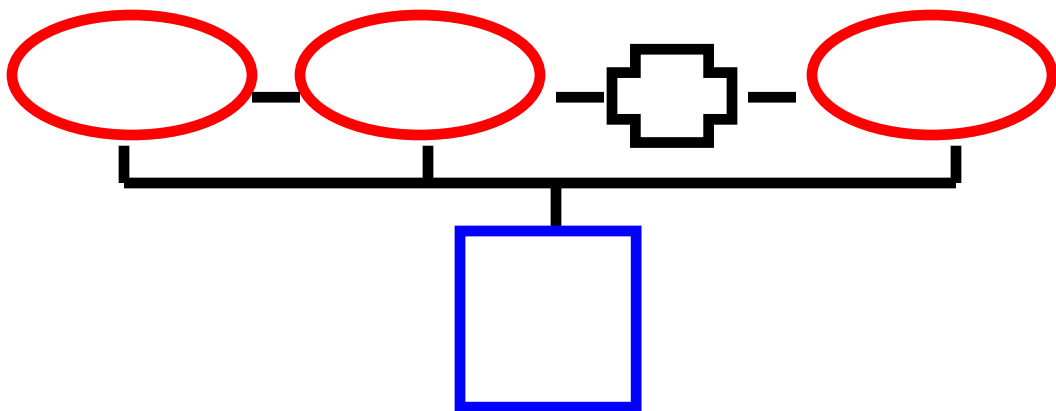
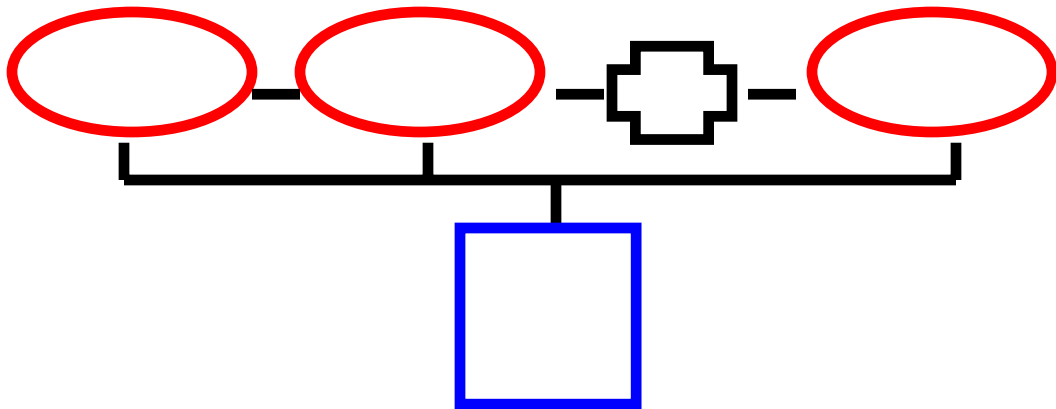

**It is easy to see why people  
like to use pronouns when  
they talk...**

**Knowing how to use pronouns  
allows me to use less words  
when talking...this makes  
talking a lot easier!**

**Remember:**

**person talking = I = me**

**person listening = you**

**Now, I can see what happens  
when I add more information  
to the **verb** part of the  
sentence...**

**Remember:**  
**A **verb** is usually an “**action**”  
word.**

The **verb tense** tells me “**when**” the action takes place...

## Verb tenses:

**present** = action is being done now

**past** = action is already finished  
= yesterday

**future** = action has not started yet =  
doing it soon or later on

**I can make a simple sentence with just one verb...**

**I will use my name as the subject...and then, I will write the same sentence using a pronoun to take the place of my name in the subject information...**

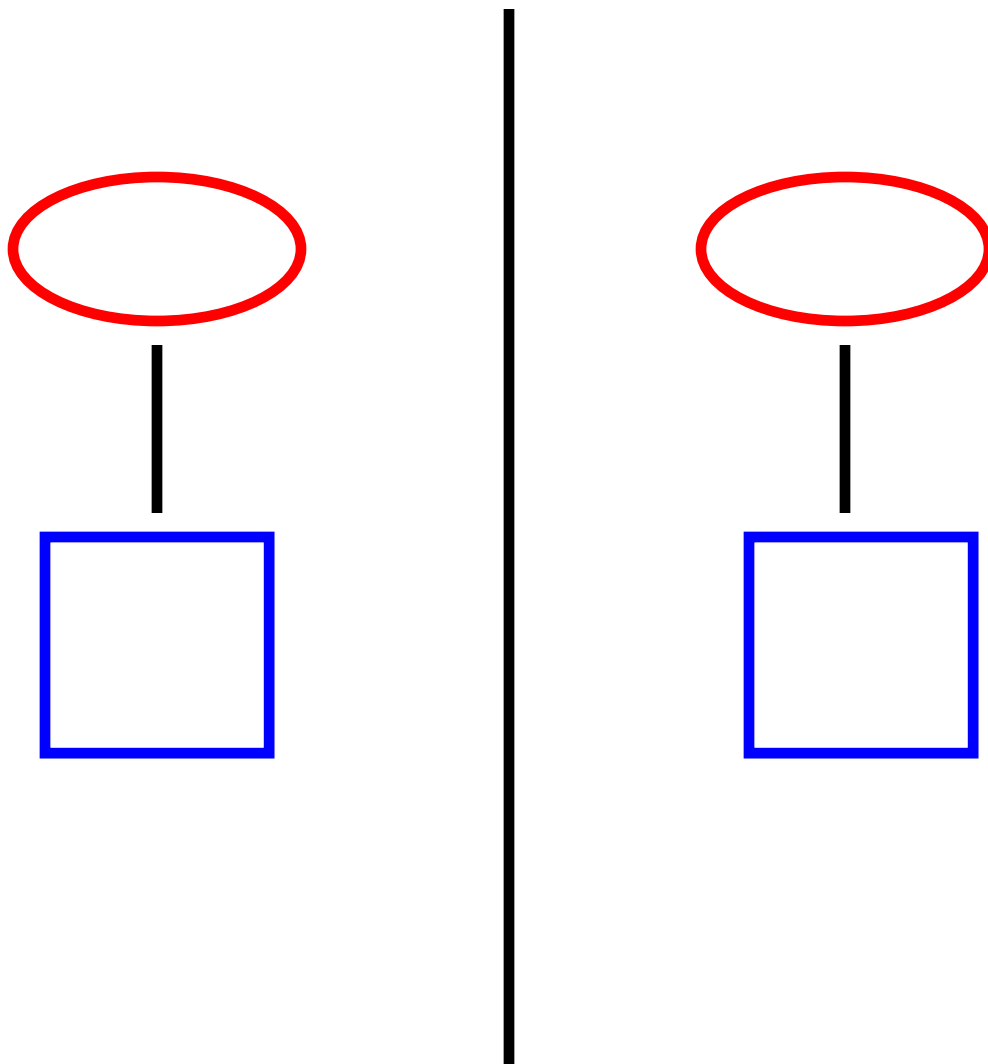

**I can make a simple sentence with just one article, one subject and one verb...**

**I will then use a pronoun to replace the subject information...**

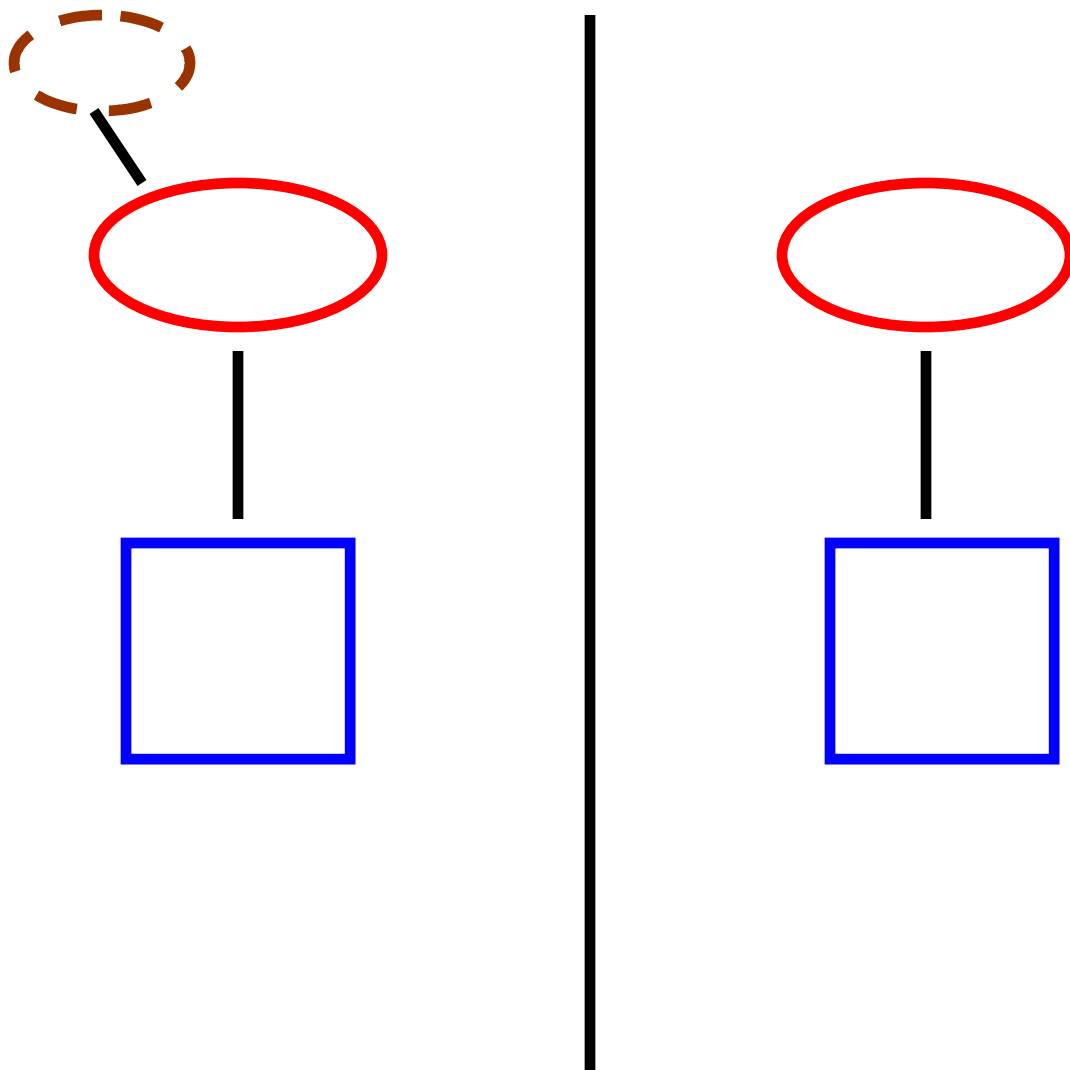



**I will write a sentence with two verbs joined by a conjunction...**

**In this sentence, I will use my name as the subject...**

**Then, I will write the same sentence using a pronoun to replace the subject...**

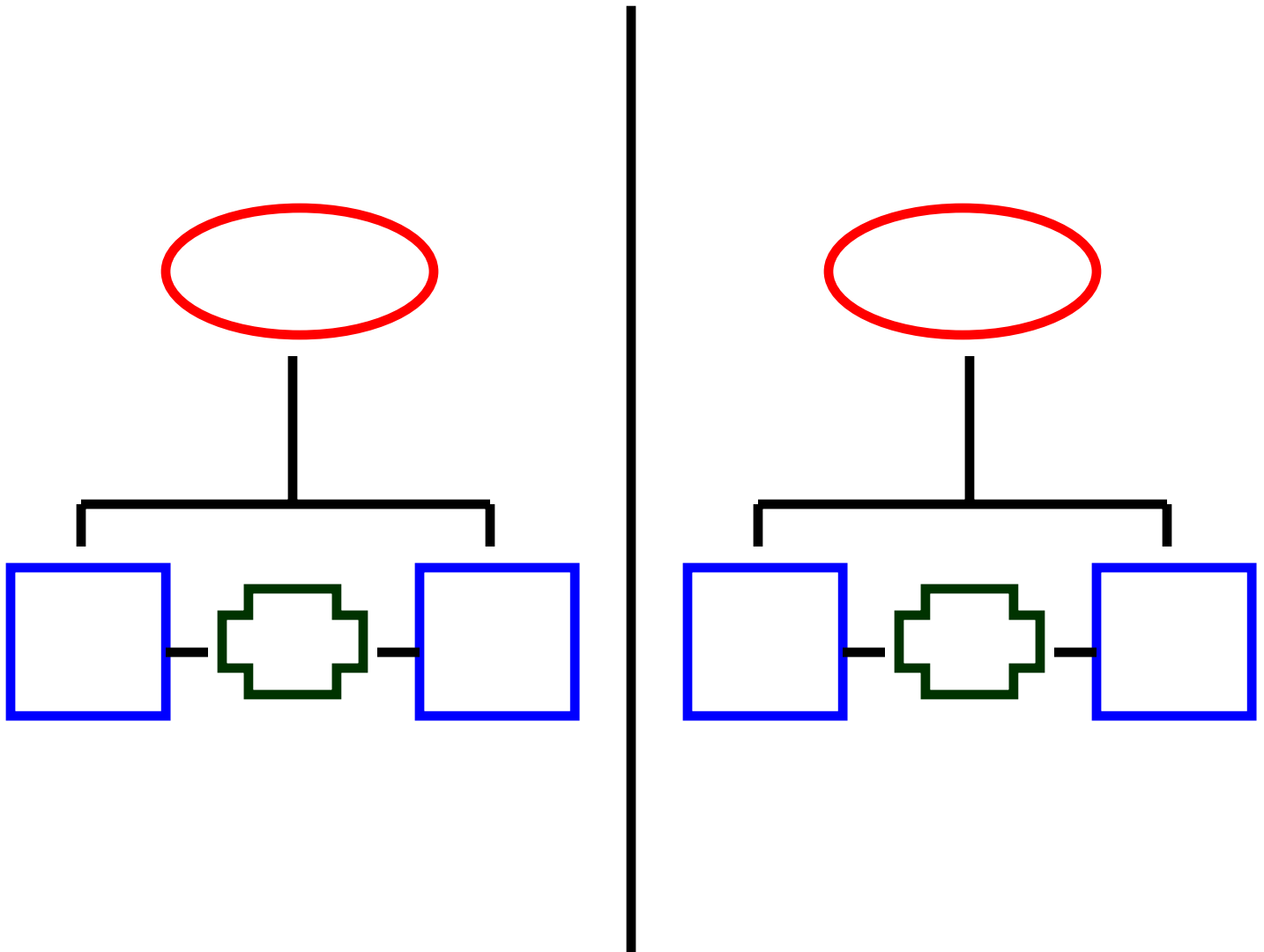

**I will write a sentence with one subject, one article and two verbs joined by a conjunction...**

**Then, I will write the same sentence using a pronoun to replace the subject...**

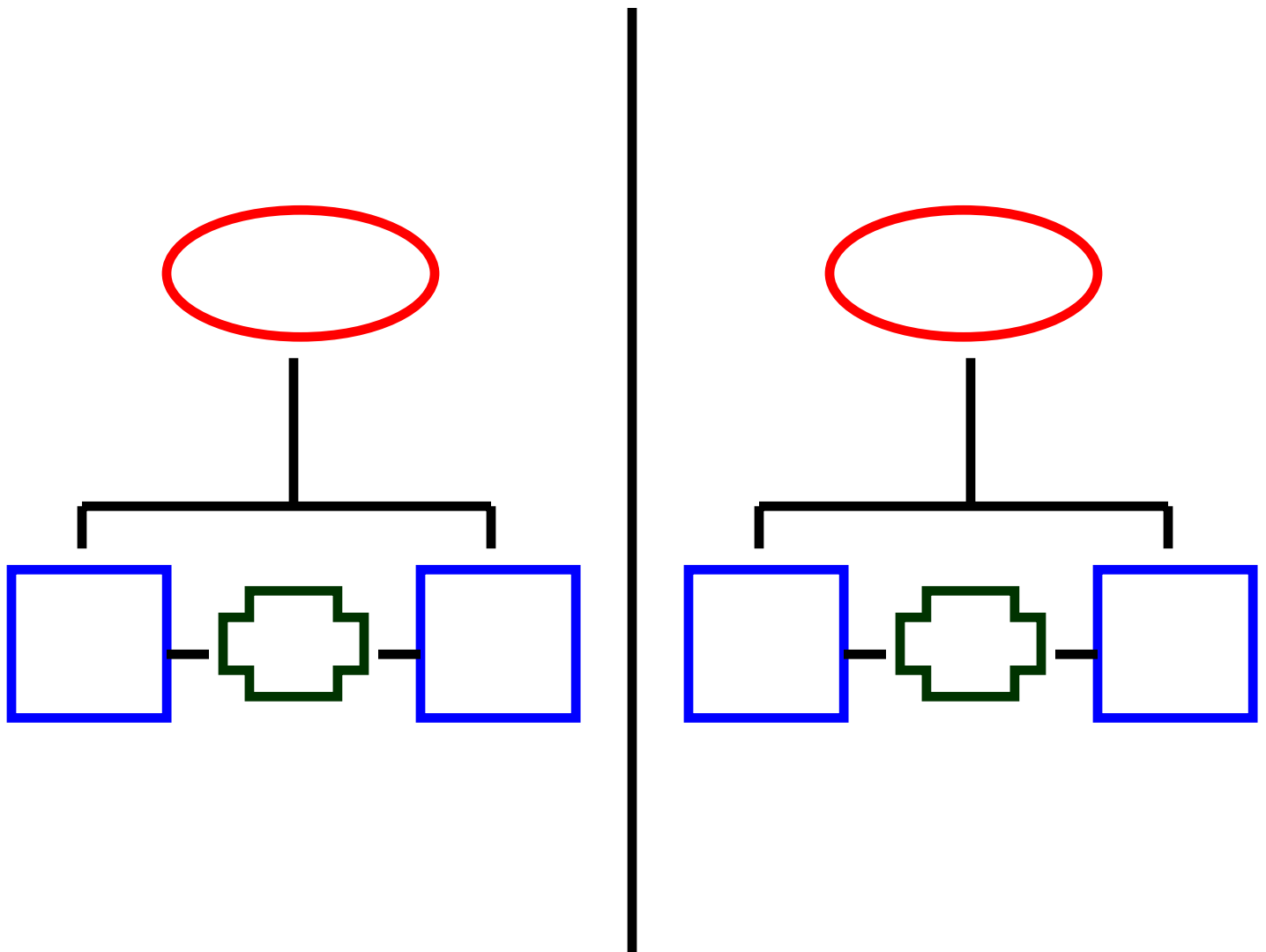

I will write a sentence with two subjects joined by a conjunction and two verbs joined by a conjunction...

I will write the same sentence using pronouns...

I can see that one pronoun takes the place of all the subject information, but the verb information stays the same in both sentences.

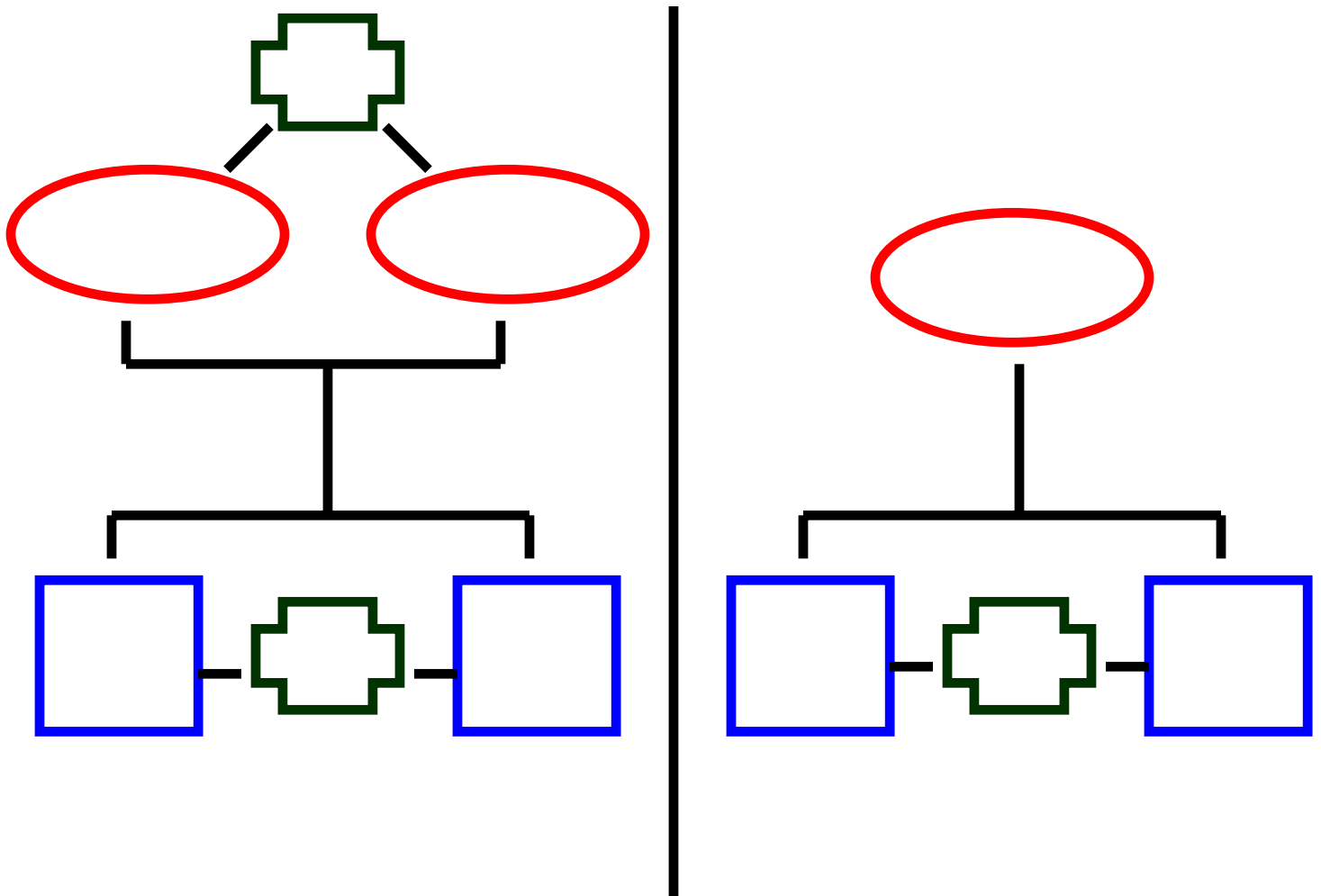

**I will write a sentence with two subjects joined by a conjunction and include adjectives and articles as well as two verbs joined by a conjunction...**

**Then, I will write the same sentence using a pronoun to take the place of the subject information...**

**Again, I can see that one pronoun can take the place of all the subject information, but... the verb information stays the same...**

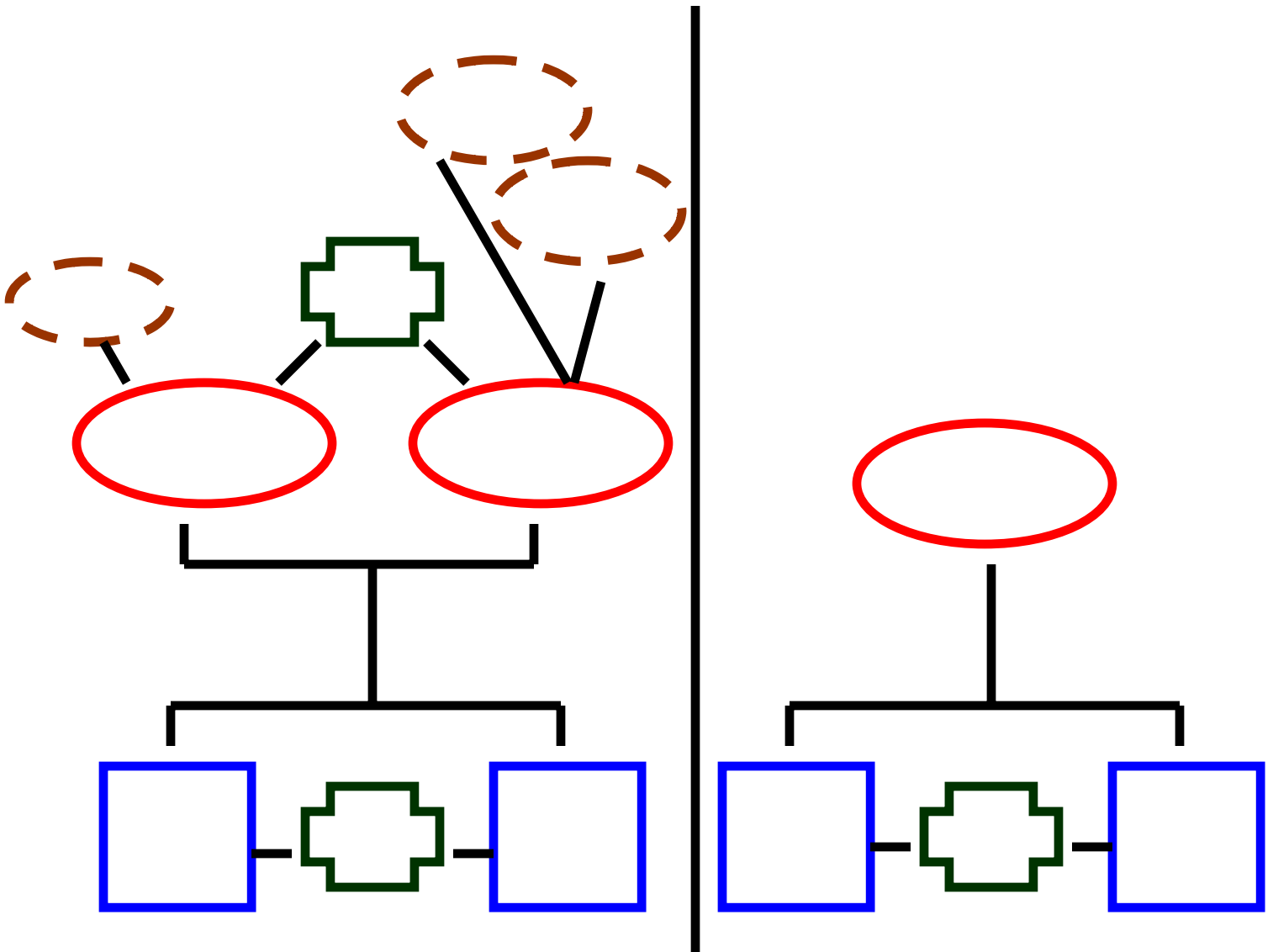

I will write a sentence with two subjects joined by a conjunction that includes some articles and adjectives in the subject information and two verbs and some adverbs for the verb information...

Then, I will write the same sentence using a pronoun to take the place of the subject information...

Again, I can see how just one pronoun can take the place of all the subject information, but...  
the verb information stays the same...

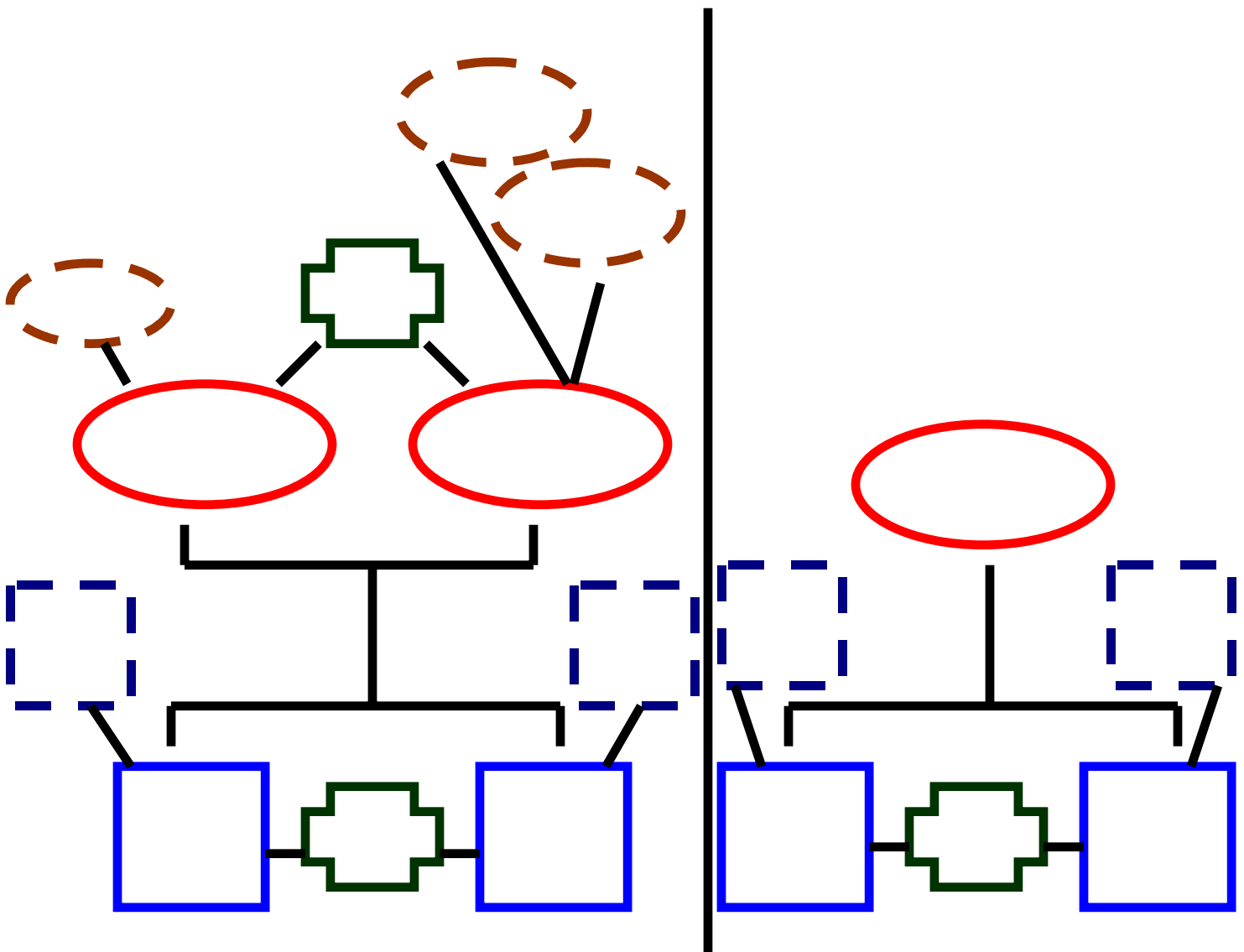

I will write a sentence with two subjects that includes some articles and adjectives where the subjects are joined by a conjunction. My sentence will also have two verbs as well as some adverbs and prepositions for the verb information ...

I will then, write the same sentence using a pronoun to take the place of the subject information... Again, I see how one pronoun can take the place of all the subject information, but the verb information stays the same...

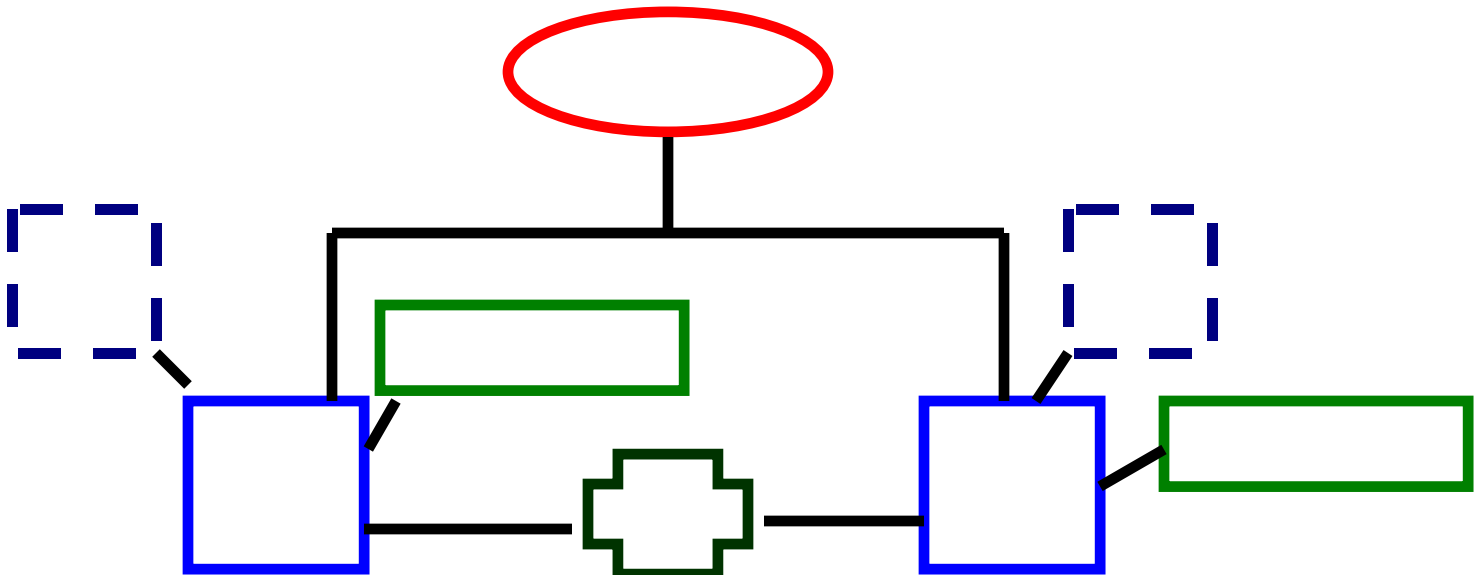
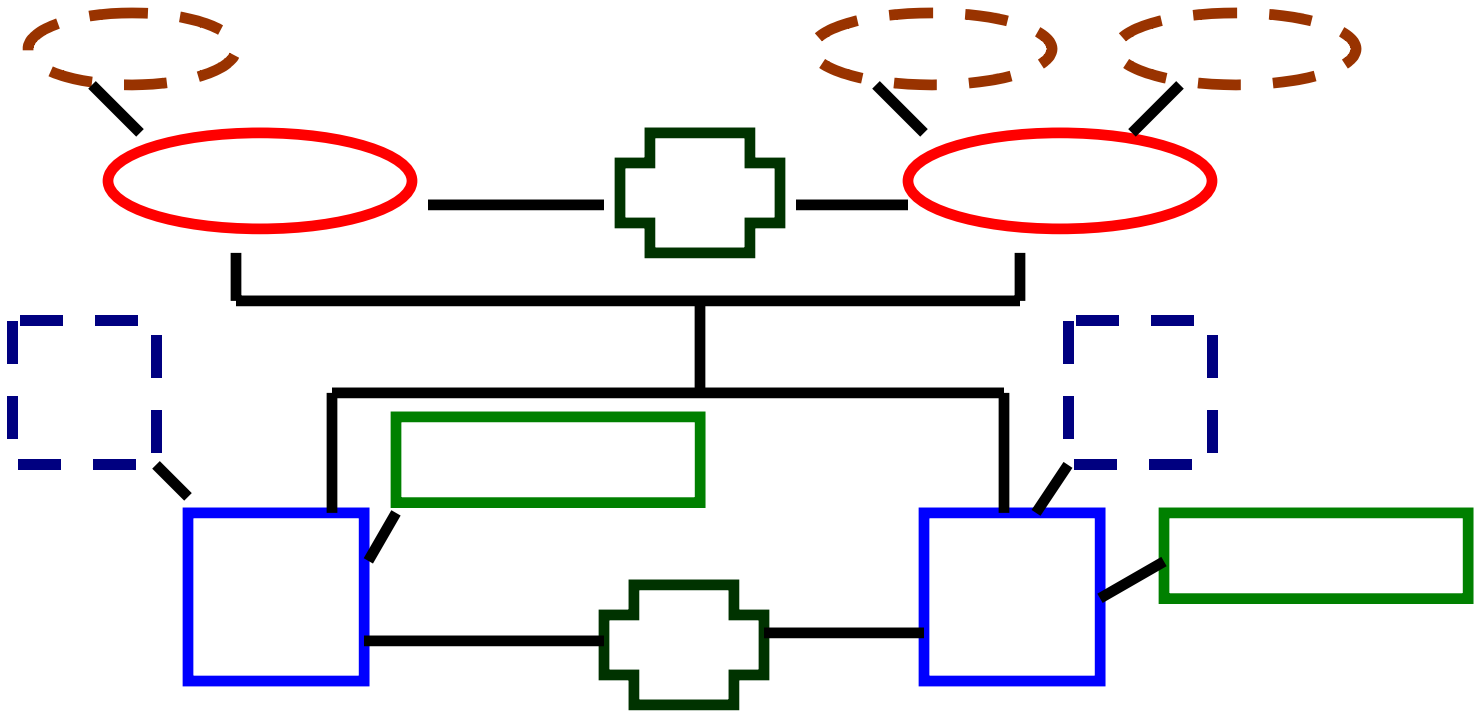

If **ALL the subjects** are **doing ALL the actions**, then, **one pronoun** can replace all the **subject information...**

But, **the verb information stays the same...** I still have to show or say **all of it!**

There are times when **one subject is doing one action** and **the other subject is doing another action....**

### **Remember:**

The **subject** is the train sentence **conductor** = **who** or **what** is doing the action, so, if different people or things are doing different actions, it is like having two conductors doing different things at the same time...

I will now see what happens in that situation...

**I will write a sentence with two subjects and two verbs  
but where the subjects are doing different things... I  
will use my name as one of the subjects...**

**I will then write the same sentence using pronouns...**

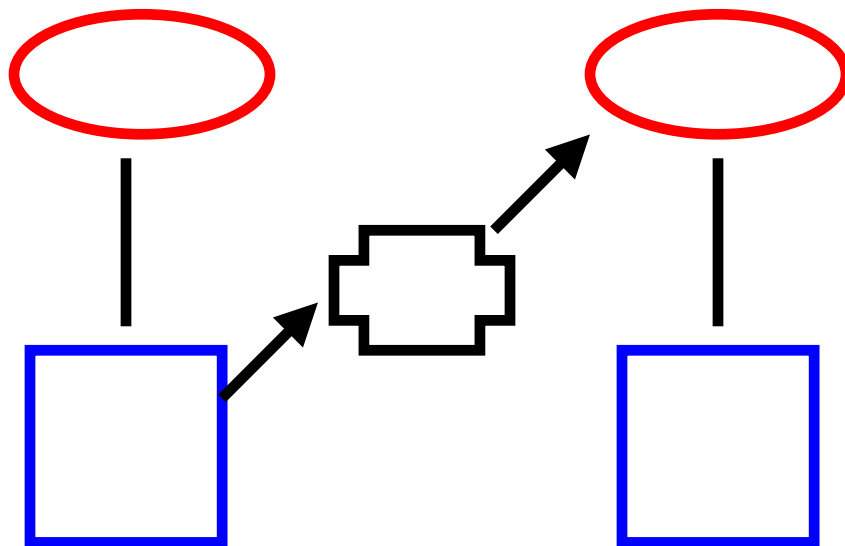
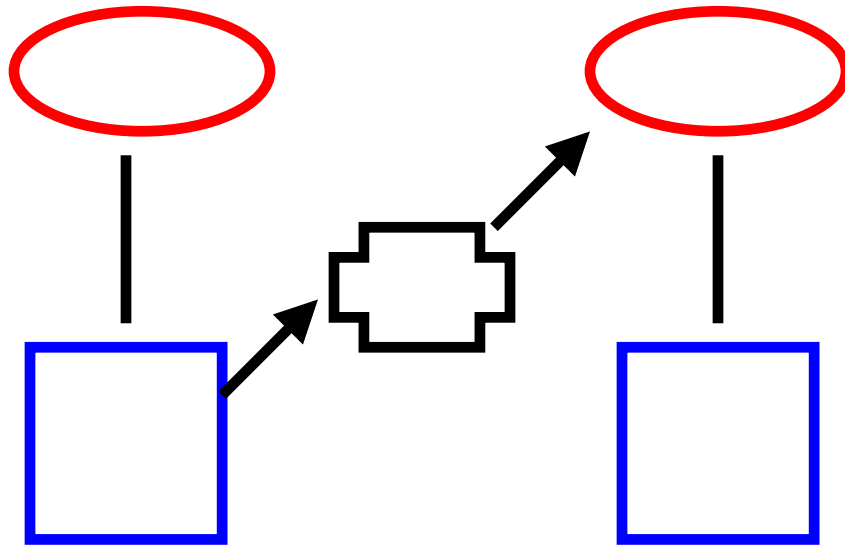



**I will write a sentence with two subjects and two verbs  
but where the subjects are doing different things...  
My sentence will include articles and adjectives...**

**I will then write the same sentence using pronouns...**

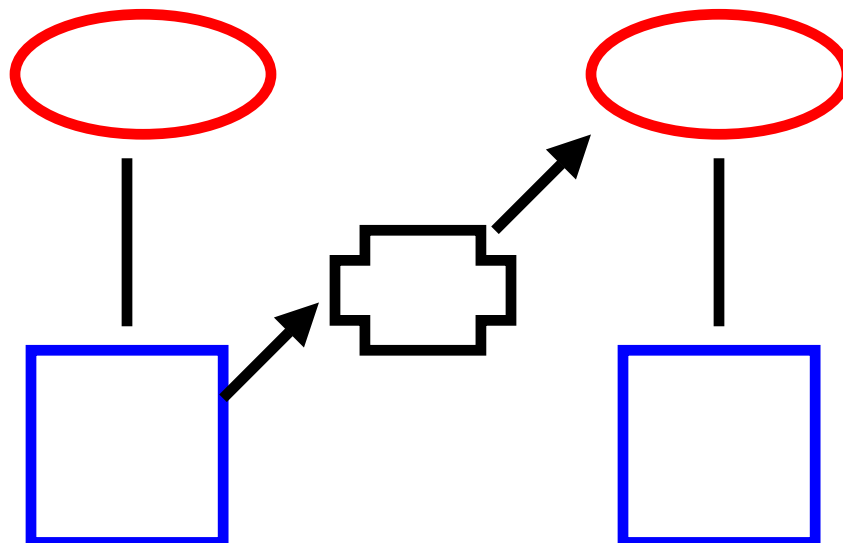
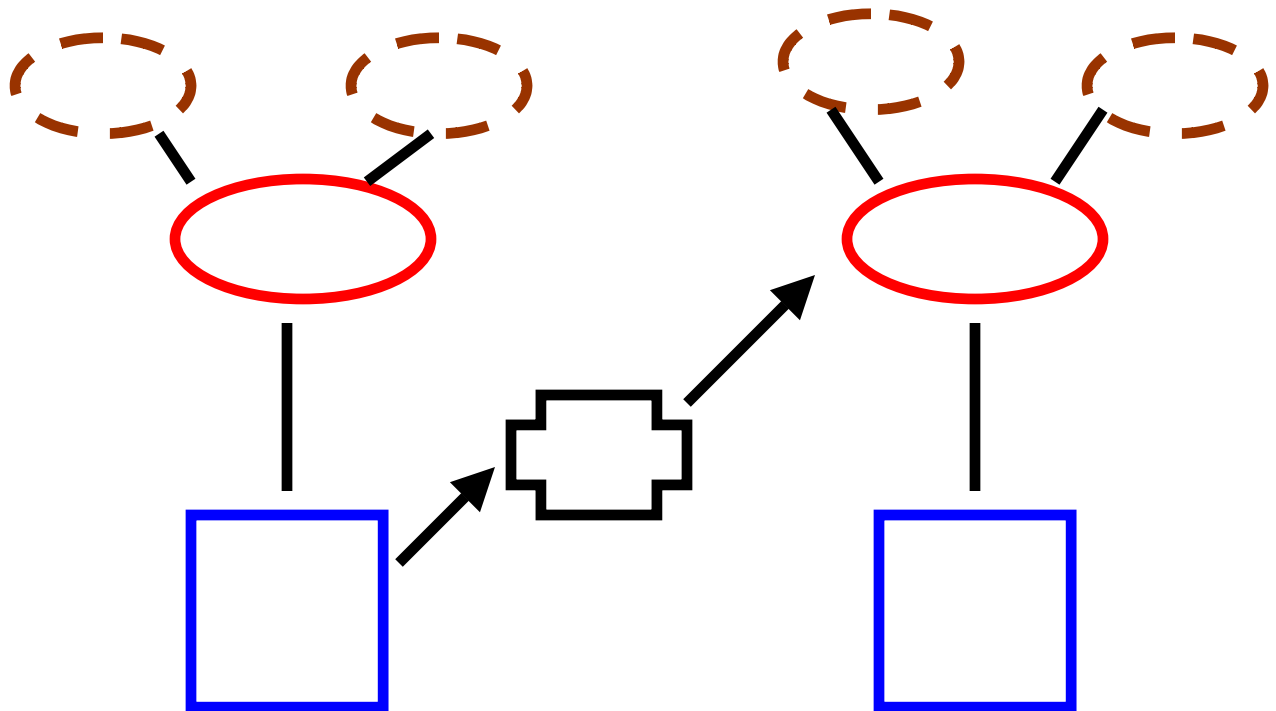

**When there is more than one subject and the subjects are doing different things, it is as though I have one sentence train for each activity and its subject(s).**

**So, I just write the sentence as though it was “different sentences” for each activity and its subject(s) and join them with a **conjunction** or “**joining word**”.**

**Remember:** There are many, many conjunctions or “joining words” ... and so, I can make many, many different sentences.

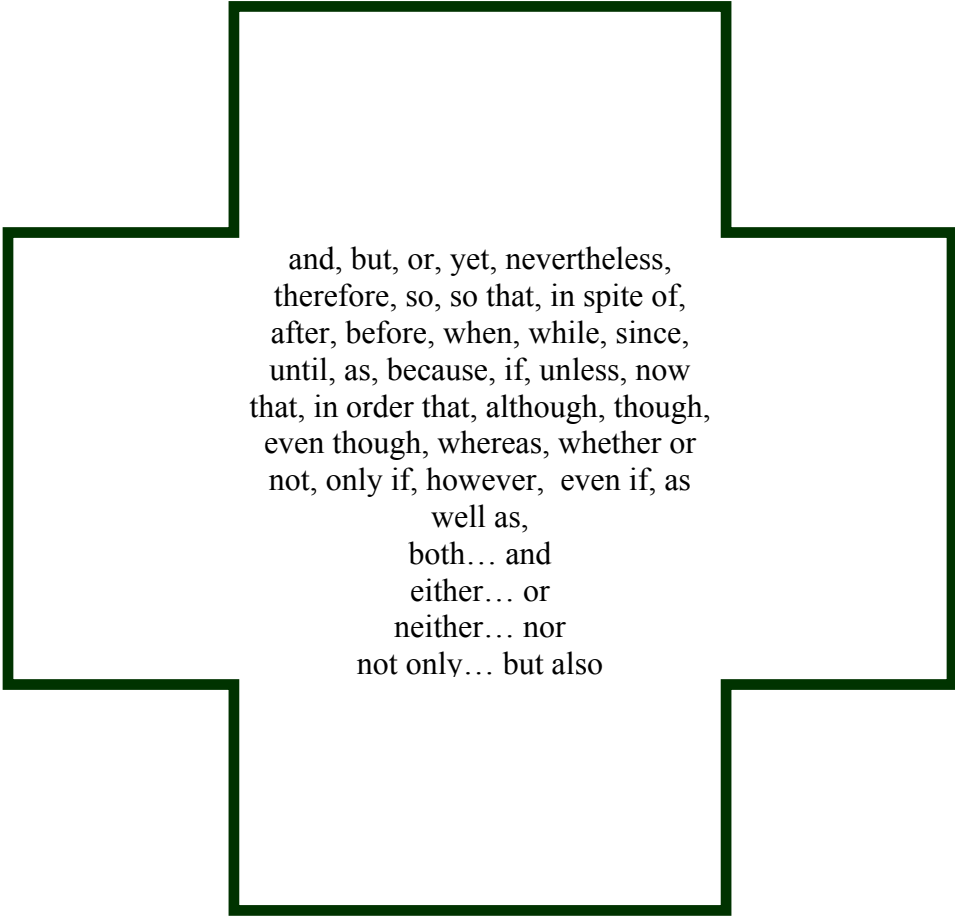

and, but, or, yet, nevertheless,  
therefore, so, so that, in spite of,  
after, before, when, while, since,  
until, as, because, if, unless, now  
that, in order that, although, though,  
even though, whereas, whether or  
not, only if, however, even if, as  
well as,  
both... and  
either... or  
neither... nor  
not only... but also

**I will write another sentence where the subjects are doing different things...**

**I will then write the same sentence using pronouns...**

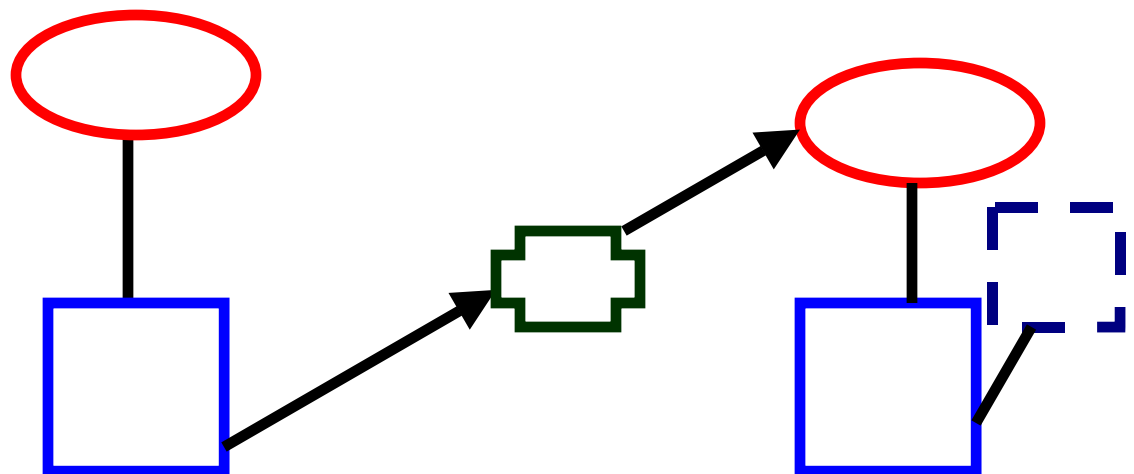
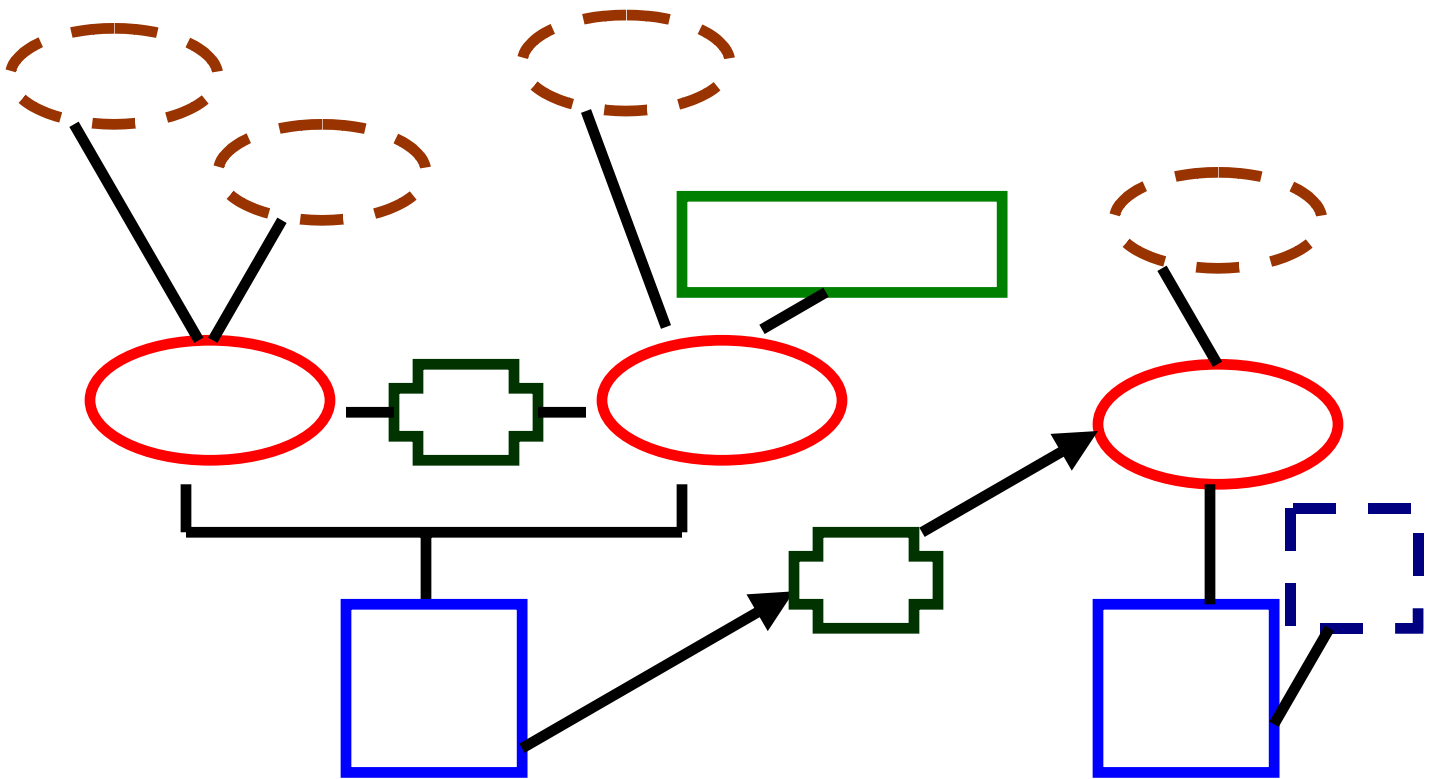

I will write a sentence with **two subjects doing different things...** and add in an **object of the verb.**

Then, I will write the same sentence using **pronouns** to replace **the subject** and **the object of the verb.**

**Remember:** The **object of the verb** is who or what the **action** is being “**done to**”.

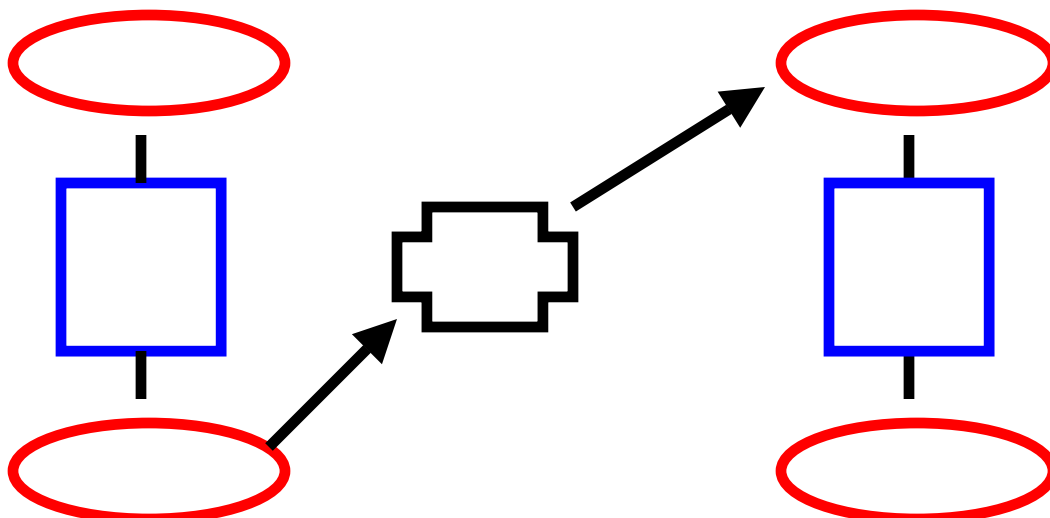
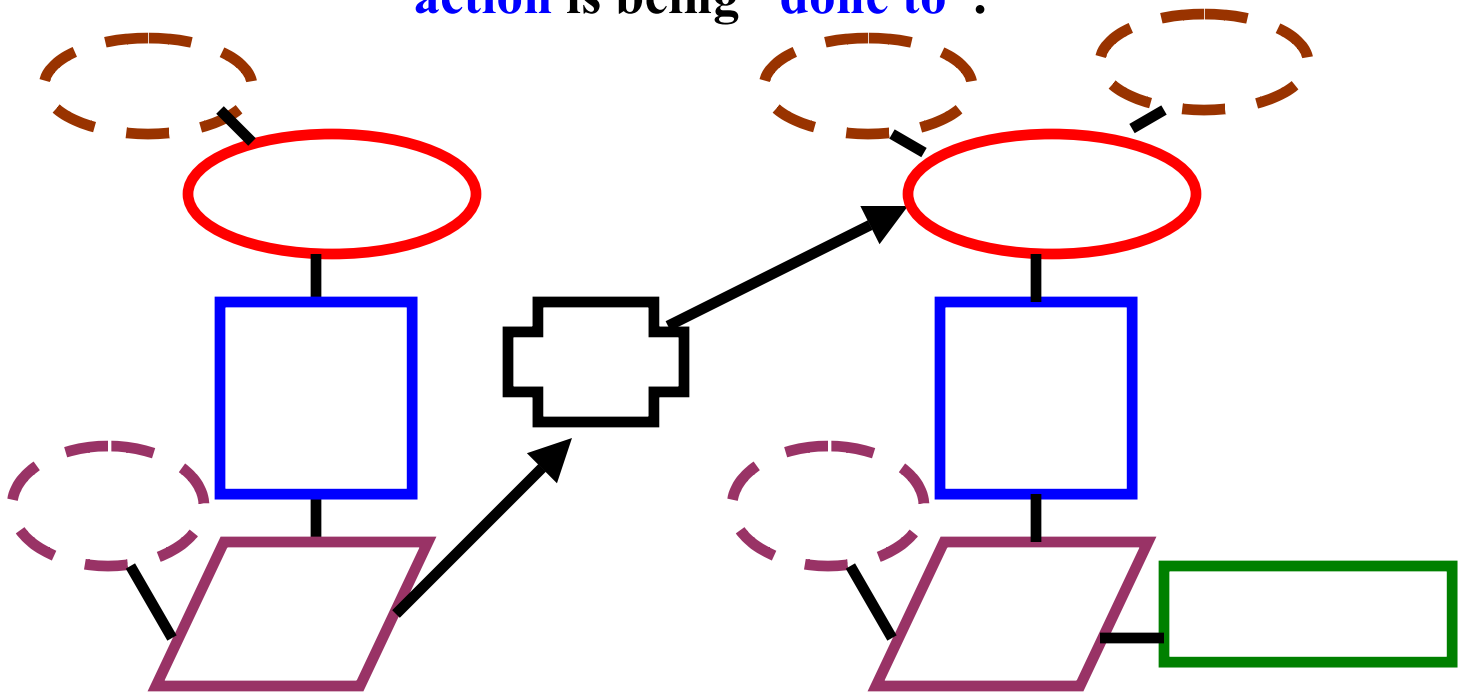

**I will write a sentence with just one subject and one verb but two objects of the verb that are joined by a conjunction...**

**I will use my name as the subject...**

**I will then write the same sentence using pronouns to replace my name and the object of the verb...**

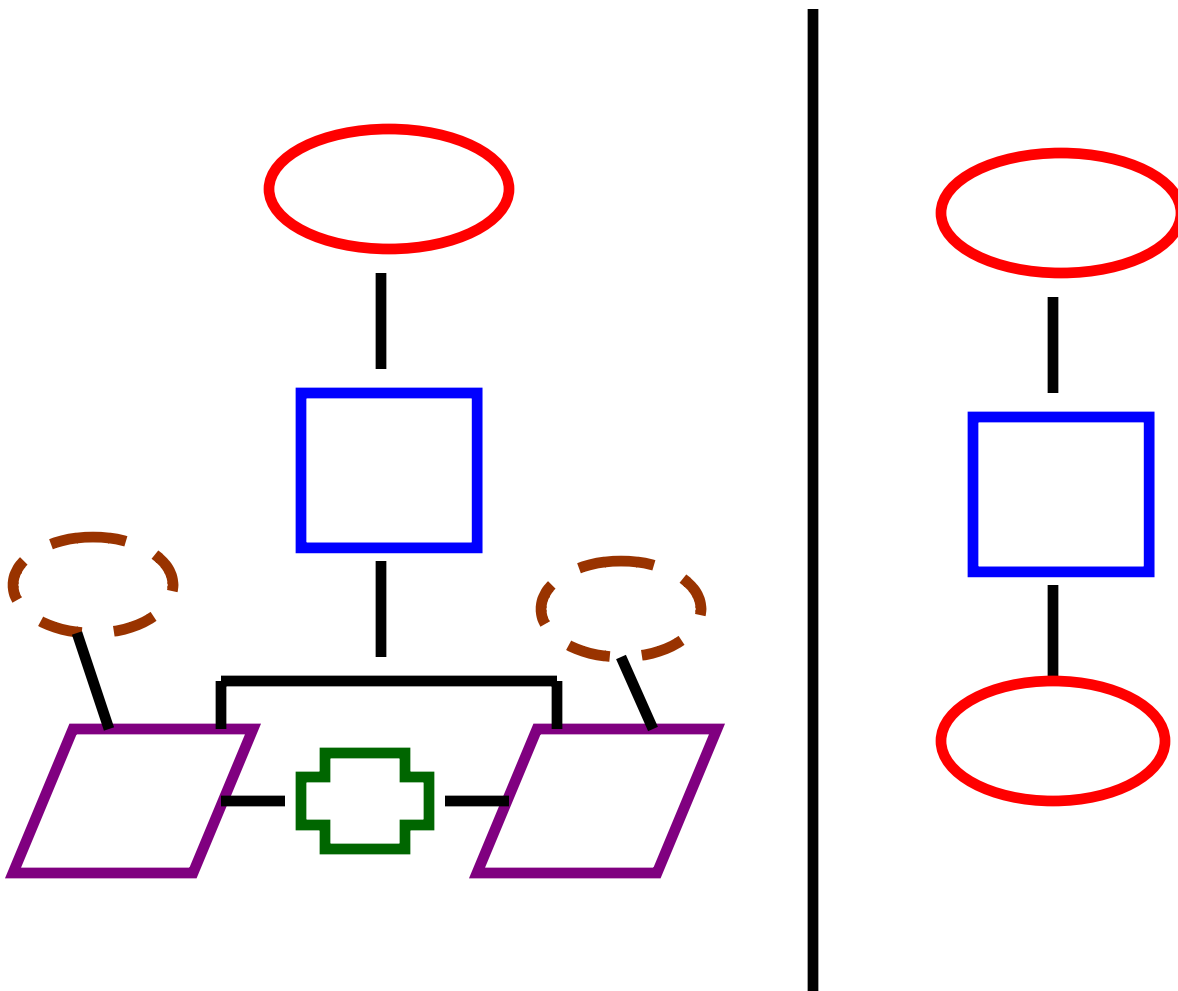

**I will write a sentence with just one subject and one verb but two objects of the verb that are joined by a conjunction...**

**I will then write the same sentence using pronouns to replace the subject and the object of the verb...**

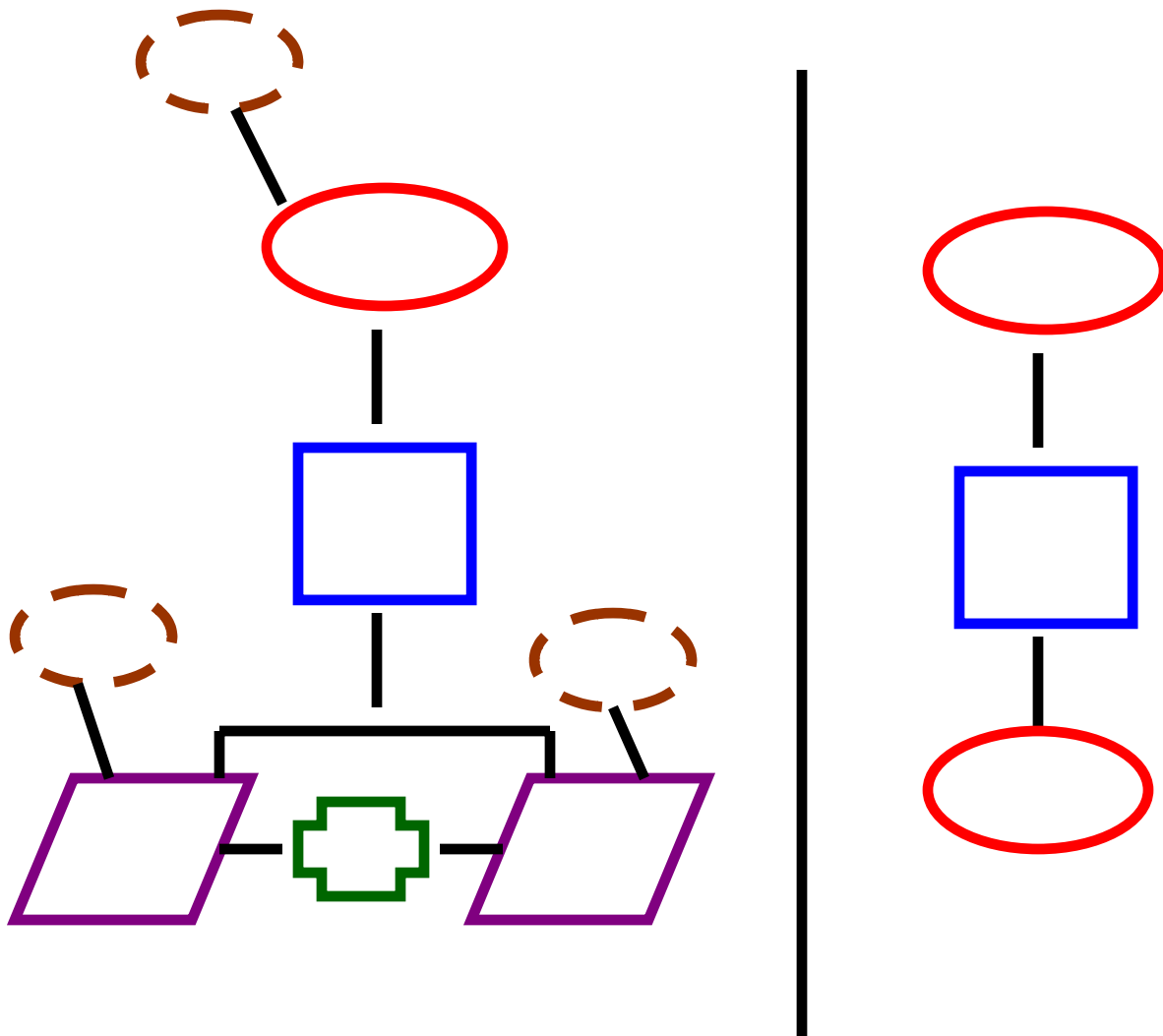

**I can see, there are many, many sentences I can make  
whether I am writing or talking.**

**The key to talking is just to know what I want to say  
and what words I want to include in my sentence.**

**Once I know how to make a sentence, it is very easy to  
write or, to talk.**

**“Conversation” or “talking” is very much like  
writing... the only difference is that when I talk, I use  
my mouth instead of a pencil and paper.**

**I know the person talking and the person listening  
“take turns” being “the conductor”... so, when  
someone else is talking, I need to listen.**

**Talking is the fastest way to communicate... and that  
is why people use talking the most when they interact.**

**To talk... all I really need to  
do is join many sentence  
trains together...**

**That is also how I write a  
story. I just put together  
sentence trains that are about  
“something”.**



**Now that I have practiced  
making sentences, I can figure  
out how to draw sentences  
someone gives me...**

**If I like, I can simply put the  
right shape around each  
word... just to make it easier.**

**The next page(s) have practice  
sentences that I can draw...**

**Run!**

**Walk and listen!**

**I have a cat.**

**My mommy and daddy are wonderful.**

**I swam in the lake.**

**I ate pretzels.**

**Mom and I are playing.**

**We like car rides.**

**The little dog, the fat cat and the rabbit were in the yard.**

**My friend is coming soon.**

**I went down the slide quickly but carefully.**

**I drew a big, fast, red rollercoaster and a tall and slow Ferris wheel.**

**She plays the piano.**

**Our kite went high in the sky.**

**The strong wind blew it away.**

**It landed in a tree.**

**He climbed the tree to get his kite.**

**The bees made a hive in our maple tree.**

**Bears sleep during the winter.**

**Playing on the computer is fun.**

**He slept while we went shopping.**

**Close the door.**

**The acorn fell from the oak tree.**

**I tied my shoelaces tightly.**

**Learning is fun.**

**It is easy to fix mistakes.**

**Everyone makes some mistakes at first.**

**I can simply try again.**

**I can ask for help when I need it.**

**Help!**

**This is easy.**

**Mom can teach me things.**

**Talking is like a puzzle.**

**You simply put pieces in place.**

**I love my family.**

**My family loves me.**

**I am happy.**

**It is a beautiful day.**

**Great job!**

**Wow!**

**My heart is full of joy.**

**I understand now.**

**I love talking with mom.**



## **Note To Parents...**

**I encourage you to graph your child's speech and hope that together, you will come up with many, many more sentence trains.**

**I provided what I saw as "the basics" to teach Zachary this concept... but, obviously, the possibilities are endless... :o)**

# End of materials



**This work, I give to you for the glory of  
my Lord and Savior, Jesus Christ.**